

Resolution of the City of Jersey City, N.J.

City Clerk File No. Res. 14..468

Agenda No. 10.A

Approved: JUL 16 2014

TITLE:

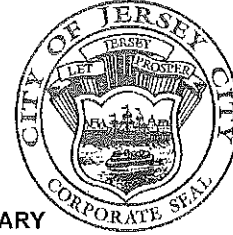

RESOLUTION AUTHORIZING AN EMERGENCY TEMPORARY APPROPRIATION

COUNCIL
adoption of the following resolution:

offered and moved

WHEREAS, it is necessary to provide an additional appropriation in the Calendar Fiscal Year 2014 temporary budget to make available the money necessary for the continuance of City services during the temporary budget period; and,

WHEREAS, no adequate provision has been made in the Calendar Fiscal Year 2014 temporary budget for the aforesaid purpose, and N.J.S.A. 40A:4-20 provides for the creation of an emergency temporary appropriation for the purpose mentioned above; and,

WHEREAS, the total temporary budget resolutions adopted in Calendar Fiscal Year 2014 pursuant to the provisions of N.J.S.A. 40A:4-19,20, including this resolution, totals **\$394,887,251.02** and,

WHEREAS, the total reflects a correction made to the Municipal Drug Alliance Grant.

NOW THEREFORE, BE IT RESOLVED by the Municipal Council of the City of Jersey City (not less than two thirds of all members thereof affirmatively concurring) that in accordance with the aforementioned statutes;

1. An emergency temporary appropriation is hereby created for:

	DIVISION	From	To
20-120	CITY CLERK OE	\$ 57,960.00	\$ 82,960.00
20-103	REAL ESTATE OE	\$ 7,860.00	\$ 9,860.00
25-240	POLICE OE	\$ 1,873,243.00	\$ 2,000,000.00
31-432	MUNICIPAL RENT	\$ 1,512,000.00	\$ 2,112,000.00
46-885	TAX OVERPAYMENTS	\$ 1,200,000.00	\$ 1,500,000.00
23-210	INSURANCE ALL DEPARTMENTS	\$ 3,720,000.00	\$ 4,220,000.00
23-220	HEALTH BENEFITS	\$ 42,566,254.00	\$ 60,566,254.00
31-433	OFFICE SERVICES	\$ 826,200.00	\$ 1,126,200.00
30-471	PRIOR YEAR BILLS	\$ 21,020.75	\$ 45,841.00
	SUMMER WORKS INITIATIVE	\$ 100,000.00	\$ 190,000.00
	TOTAL INCREASE:		\$ 19,968,577.25

2. Said emergency temporary appropriation will be provided for in the Calendar Fiscal Year 2014 Municipal Budget.

APPROVED: [Signature] City Clerk

APPROVED AS TO LEGAL FORM

APPROVED: [Signature] Business Administrator

[Signature] Corporation Counsel

Certification Required

Not Required

APPROVED 9-0

RECORD OF COUNCIL VOTE ON FINAL PASSAGE											
COUNCILPERSON	AYE	NAY	N.V.	COUNCILPERSON	AYE	NAY	N.V.	COUNCILPERSON	AYE	NAY	N.V.
GAJEWSKI	✓			YUN	✓			RIVERA	✓		
RAMCHAL	✓			OSBORNE	✓			WATTERMAN	✓		
BOGGIANO	✓			COLEMAN	✓			LAVARRO, PRES	✓		

✓ Indicates Vote

N.V.-Not Voting (Abstain)

Adopted at a meeting of the Municipal Council of the City of Jersey City N.J.

[Signature]
Rafaelo R. Lavarro, Jr., President of Council

[Signature]
Robert Byrne, City Clerk

RESOLUTION FACT SHEET – NON-CONTRACTUAL

This summary sheet is to be attached to the front of any resolution that is submitted for Council consideration. Incomplete or vague fact sheets will be returned with the resolution.

Full Title of Ordinance/Resolution

ET (Resolution Authorizing an Emergency Temporary Appropriation)

Initiator

Department/Division	Administration	Budget
Name/Title	Rozani Pelc-Penteado	Principal Account Clerk
Phone/email	201-547-4964	PelcR@jcnj.org

Note: Initiator must be available by phone during agenda meeting (Wednesday prior to council meeting @ 4:00 p.m.)

Resolution Purpose

To increase temporary budget to cover contractual expenses for Municipal Rent Account and City Clerk's Office.
An increase in funds to cover expenses for Real Estate Office and Police, as well as funds for tax overpayments.

I certify that all the facts presented herein are accurate.

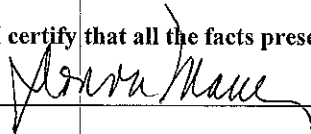

July 7, 2014

Resolution of the City of Jersey City, N.J.

City Clerk File No. Res. 14.469

Agenda No. 10.B

Approved: JUL 16 2014

TITLE:



RESOLUTION (1) INTRODUCING AND APPROVING THE 2014-2015 BUDGET OF THE CENTRAL AVENUE SPECIAL IMPROVEMENT DISTRICT; (2) DIRECTING THE CITY CLERK TO PUBLICLY ADVERTISE THE BUDGET AND SCHEDULE A PUBLIC HEARING; AND (3) DIRECTING THE TAX ASSESSOR TO PREPARE AN ASSESSMENT ROLL OF PROPERTIES WITHIN THE DISTRICT BASED UPON THE BUDGET

COUNCIL offered and moved adoption of the following Resolution:

WHEREAS, pursuant to N.J.S.A. 40:56-71 et seq., and by the adoption of **Ordinance 92-087** the City of Jersey City established the Central Avenue Special Improvement District (CASID) to be operated by the Central Avenue Special Improvement District Management Corporation; and

WHEREAS, under N.J.S.A. 40:56-80, the District Management Corporation must prepare an annual budget that includes an estimate of the annual costs of operating the district including:

- (1) the costs charged against municipal funds for general street maintenance;
- (2) the costs charged against properties within the District in proportion to the benefits conferred by the annual improvements;
- (3) costs, if any, to be assessed against properties in the District; and

WHEREAS, upon receipt of the budget, the Municipal Council is required to consider the budget, approve the budget, schedule a public hearing and adopt the budget with such amendments as the governing body considers necessary; and

WHEREAS, upon approval of the budget the Tax Assessor is required to prepare an assessment roll listing the properties to be specially assessed in accordance with the budget and calculate the amount of the assessment to be charged to each property; and

WHEREAS, the District Management Corporation of Central Avenue Special Improvement District has submitted its 2014-2015 fiscal year budget, July 1, 2014 – June 30, 2015 to the Council, a copy of which is attached hereto as Exhibit A; and

NOW, THEREFORE BE IT RESOLVED, with a majority of the full membership of the Council concurring that:

1. The 2014-2015 fiscal year budget, July 1, 2014 – June 30, 2015 of the Central Avenue Special Improvement District, attached hereto as Exhibit A, was approved by the Central Avenue Special Improvement District at its June 3, 2014 meeting;
2. The budget as submitted to the City is hereby retroactively introduced and approved, subject to a public hearing prior to adoption.
3. The Tax Assessor is directed to do the following:

TITLE:

- (a) prepare an assessment roll specifying the amounts specifically assessed against each benefitted and assessable property in the District in proportion to the benefit conferred, based upon the approved budget in accordance with the procedures prescribed in N.J.S.A.40:56-80(c). Such assessment roll shall include a description of each property and the names of the owners; and
 - (b) file the assessment roll in the Office of the City Clerk to be available for public inspection.
4. The City Clerk is directed to do the following:
- (a) schedule a public hearing on the budget and the amount of the assessments not less than 28 days from the date of this Resolution;
 - (b) at least 10 days prior to the date of the hearing public (i) a notice setting the time and place of the public hearing on the budget and amounts of the special assessments; and (ii) a copy of the entire budget in a newspaper of general circulation;
 - (c) at least 10 days prior to the date the notice is published, send a copy of the notice of public hearing to the named owners of each property proposed to be assessed; and
 - (d) at least 10 days before the date of the scheduled hearing
 - (i) post a complete copy of the approved budget in City Hall in the customary location for posting public notices;
 - (ii) post a complete copy of the assessment roll in City Hall in the customary location for posting public notices; and
 - (iii) make available a copy of the budget to any person requesting it up to and including the date of the public hearing.
5. Upon approval of the assessment roll with any changes approved by the Council, the City Clerk shall immediately certify a copy of the assessment roll to the County Tax Board to be effective as of July 1, 2014.

APPROVED: _____

APPROVED AS TO LEGAL FORM

APPROVED:  _____

Business Administrator

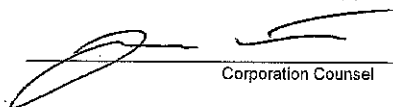
 _____

Corporation Counsel

Certification Required

Not Required

APPROVED **9-0**

RECORD OF COUNCIL VOTE ON FINAL PASSAGE 7.16.14											
COUNCILPERSON	AYE	NAY	N.V.	COUNCILPERSON	AYE	NAY	N.V.	COUNCILPERSON	AYE	NAY	N.V.
GAJEWSKI	✓			YUN	✓			RIVERA	✓		
RAMCHAL	✓			OSBORNE	✓			WATTERMAN	✓		
BOGGIANO	✓			COLEMAN	✓			LAVARRO, PRES.	✓		

✓ Indicates Vote

N.V.-Not Voting (Abstain)

Adopted at a meeting of the Municipal Council of the City of Jersey City N.J.

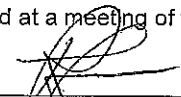

Rolando R. Lavarro, Jr., President of Council



Robert Byrne, City Clerk



"A Tradition Reborn"

CENTRAL AVENUE

S.I.D. MANAGEMENT CORPORATION

366 Central Avenue, Suite 201 Jersey City, NJ 07307

Ph: (201) 656-1366

Fx: (201) 656-4037

www.CentralAveSID.org

BOARD OF TRUSTEES

Sanford Fishman, *President*

Joe Nachbaur, *Vice President - N*

Gilbert Mendez, *Vice President - S*

Sergio Ferreira, *Treasurer*

Gary Solomon, *Secretary*

Grace Cutri, *Trustee*

Eddy Gallo, *Trustee*

Petitions and Communications
6.z1

Meeting 06/25/2014

Resolution No. 2014-06-1

RESOLUTION ACKNOWLEDGING DIRE REDUCTION IN MUNICIPAL PUBLIC FUNDS IN THE 2015 FISCAL YEAR BUDGET OF THE CASID

THE BOARD MEMBERS OF THE CORPORATION OFFERED AND MOVED ADOPTION OF THE FOLLOWING RESOLUTION:

WHEREAS, pursuant CASID Resolution No. 2014-03-1, it was resolved by the Membership of the Central Avenue Special Improvement District Management Corporation that a majority of its members voting at the Annual Meeting held on TUESDAY MARCH 18, 2014 agreed to the proposed budget describing the revenues and expenses of the CASID set forth at the Annual Meeting equal to \$262,893 for the Fiscal Year July 1, 2014- June 30, 2015.

WHEREAS, the CASID FY budget 2014-2015 represents an investment to guide the social and economic growth in the City of Jersey City by providing supplemental management, maintenance, and improvements to the Central Avenue business district home to approximately 1,400 jobs and two hundred forty (240) storefronts; and

WHEREAS, the Members of the District Management Corporation (all commercial property and/ or business owners within the district) elect to make the investment of \$92,370 in Jersey City through a Special Improvement District program in addition to commercial property taxes collected from the district; and

WHEREAS, the CASID FY budget 2014-2015 requests an equal public/ private partnership between the Members of the District Management Corporation and the City of Jersey City to guard existing ratable, job retention, generate economic development through small business, and substantially contribute to the infrastructure of the City's business environment thereby providing substance (i.e. efficient sidewalk and street cleaning, holiday decorations, maintenance of the commercial area) to the characterization of Jersey City as "business friendly"; and

WHEREAS, the priorities set forth in the City of Jersey City proposed 2014 municipal budget totaling \$501 million includes a \$29,787,848 surplus balance yet does not allow for investment or meaningful economic development in the City's commercial districts; and

WHEREAS, the City of Jersey City requests an amend to the CASID FY budget 2014-2015 thereby reducing a request for Public Funds equal from \$92,370 (less than 1/10th of 1 percent of the \$501 million 2014 city budget) to \$0.00; and

WHEREAS, the reduction of public funds will have adverse effects on services provided to the Central Avenue business district including holiday lighting/ streetscape decorations; Central Avenue's private Sidewalk Sweeping operation will not be restored; the organization has consequently lost the ability to acquire most "Private/ Other Funding" described in the original budget (\$78,153); and hopes of returning the Everything Jersey City Festival have been abolished; and

WHEREAS, the original CASID FY budget 2014-2015 included a note to the Members of the District Management that the loss of public funding will compromise the aforementioned services leaving the CASID budget primarily reliant on the SID Assessment revenue and expenses; and

NOW, THEREFORE, BE IT RESOLVED by the Board of Trustees of the Central Avenue Special Improvement District Management Corporation acknowledges the request by the City of Jersey City to reduce Public Funds from \$92,370 to \$0.00 thereby decreasing the CASID Fiscal Year budget July 1, 2014- June 30, 2015 to \$105,870 (a loss of nearly \$157,023 in services to the district).

PASSED and adopted on this 3rd day of June, 2014.

ATTEST:

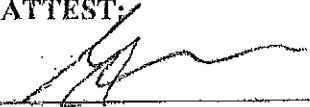

Gary Solomon, Secretary
(Seal)

APPROVED:

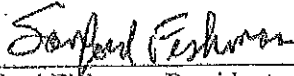

Sanford Fishman, President

Record of Trustee Vote on Final Passage			
TRUSTEE	AYE	NAY	N.V.
CUTRI	✓		
FERREIRA	✓		
FISHMAN, PRES	✓		
GALLO	✓		
MENDEZ	Absent		
NACHBAUR	✓		
SOLOMON	✓		
TOTAL =	6	0	0

✓ INDICATES VOTE

N.V. --- NOT VOTING (Abstain)

Central Avenue SID Budget for FY15

Central Avenue SID Management Corporation
 366 Central Avenue, Suite 201 Jersey City NJ 07307
 Ph: 201.656.1366 Fx: 201.656.4037



Central Avenue
 SPECIAL IMPROVEMENT DISTRICT
 www.JCHeights.com

Fiscal Year Budget July 1, 2014 - June 30, 2015 (**Amended)

Note: Members of the CASID voted to approve the 2015 budget at the Annual Meeting of the Corporation held 6:00 PM on Tuesday March 18, 2014 in the CASID Office.

#	Items	*SID Assessment	Public Funds	Private/ Other	Total
REVENUES					
1	SID Assessment	92,370			92,370
2	Public Funds (City/ UEZ Grant)		0		0
3	Private/ Sponsorships			13,500	13,500
TOTAL REVENUES =		92,370	0	13,500	\$ 105,870
EXPENSES					
<i>Administrative Items</i>					
4	Audit & Accounting	2,670			2,670
5	Rent	6,900			6,900
6	Equipment	1,500			1,500
7	Office Supplies	3,000			3,000
8	Telephone/ Internet	1,838			1,838
9	Insurance (Director's, General Liability)	2,000			2,000
10	Other Professional Fees (i.e. legal, license.)	2,000			2,000
Subtotal=		19,908			\$ 19,908
<i>Business Retention/ Economic Development</i>					
11	Communication & Legal Notices	8,700	-	2,000	10,700
12	Special Events (i.e. sidewalk sales/ creative placemaking)	15,762	-	1,000	16,762
13	Holiday Lighting/ Streetscape Decorations	-	-	10,500	10,500
Subtotal=		24,462	-	13,500	\$ 37,962
<i>Operation (Sidewalk Cleaning)</i>					
14	Staff (4x staffers, payroll taxes, etc)	-	-	-	-
15	Garbage Bags	-	-	-	-
16	Communication/ Cell Phone Service	-	-	-	-
17	Uniforms	-	-	-	-
18	Storage	-	-	-	-
19	Miscellaneous Supplies	-	-	-	-
Subtotal=		-	-	-	\$ -
<i>Program Labor</i>					
20	MKTG/ PR/ COORD/ MGMT (Bundled Services)	48,000			48,000
Subtotal =		48,000	-	-	\$ 48,000

TOTAL EXPENSES =		92,370	0	13,500	\$ 105,870
-------------------------	--	---------------	----------	---------------	-------------------

REVENUE / EXPENSE SUMMARY					
		SID Assessment	Public	Private/ other	Total
Revenues	\$	92,370	\$ -	\$ 13,500	\$ 105,870
Expenses	\$	92,370	\$ -	\$ 13,500	\$ 105,870
Excess / Deficiencies	\$	-	\$ -	\$ -	\$ -

***Attention CASID Members:** Your SID assessment is an investment in Jersey City and supplement to property taxes. The City of Jersey City has traditionally matched your investment in the commercial district to create an equal public/ private partnership in the mission to create an environment where small businesses can succeed, create local jobs, keep a desirable main street appearance, stabilize neighborhood property value and move Jersey City forward. Mayor Fulop and the Municipal Council have again been asked to restore the City's commitment to the success of its neighborhood shopping districts by allocating \$92,370 in Public Funds to the SID.

****In May 2014, the request for public funds was denied.** City officials requested an amendment to CASID's budget slashing \$92,370 in services described in the "Public Funds" column above (Holiday Lights = \$10,500; Sidewalk Cleaning = \$81,870). As a result, Central Avenue's private Sidewalk Sweeping operation will not be restored; the organization has consequently lost the ability to acquire most "Private/ Other Funding" described in the original budget (\$78,153); and hopes of returning the Everything Jersey City Festival have been abolished. As previously noted, the column labeled "SID Assessment" remains unchanged and has become the general operating budget.

Resolution of the City of Jersey City, N.J.

City Clerk File No. Res. 14.470
 Agenda No. 10.C
 Approved: JUL 16 2014



TITLE:

RESOLUTION URGING THAT CORPORATE RESPONSIBILITY IS CRITICAL TO QUALITY NURSING HOME CARE

COUNCIL Offered and moved adoption of the following Resolution:

Whereas, many Jersey City families rely on skilled caregivers at Alaris Health at Harborview to give round-the-clock care to their loved ones in their times of need; and

Whereas, these caregivers are responsible for feeding, dressing, bathing, providing emotional support and other essential daily care to their patients; and

Whereas, proper staffing and continuity of care are critical components to achieving positive health outcomes; and

Whereas, low wages and unaffordable family health benefits jeopardize these aspects of care by contributing to high turnover and loss of skilled caregivers; and

Whereas, Alaris Health is a profitable company, having earned over \$125 million in profit between 2010-2012 according to the Medicaid cost reports; and

Whereas, Alaris Health at Harborview is supported primarily through revenue from public sources; and

Whereas, Jersey City has a vested interest in fostering stable employment and protecting vital health services;

NOW, THEREFORE, BE IT RESOLVED by the Municipal Council of the City of Jersey City that that we support the members of 1199SEIU in their efforts to hold Alaris Health accountable for good jobs and quality resident care.

APPROVED: _____

APPROVED AS TO LEGAL FORM

APPROVED: _____
 Business Administrator

 Corporation Counsel

Certification Required

Not Required

APPROVED 9-0

RECORD OF COUNCIL VOTE ON FINAL PASSAGE 7.16.14											
COUNCILPERSON	AYE	NAY	N.V.	COUNCILPERSON	AYE	NAY	N.V.	COUNCILPERSON	AYE	NAY	N.V.
GAJEWSKI	✓			YUN	✓			RIVERA	✓		
RAMCHAL	✓			OSBORNE	✓			WATTERMAN	✓		
BOGGIANO	✓			COLEMAN	✓			LAVARRO, PRES	✓		

✓ Indicates Vote

N.V.-Not Voting (Abstain)

Adopted at a meeting of the Municipal Council of the City of Jersey City N.J.

 Rolando R. Lavarro, Jr., President of Council

 Robert Byrne, City Clerk

Resolution of the City of Jersey City, N.J.

City Clerk File No. Res. 14.471

Agenda No. 10.D

Approved: JUL 16 2014

TITLE:



RESOLUTION MANDATING THE USE OF DIRECT DEPOSIT FOR EMPLOYEE PAYCHECKS

COUNCIL offered and moved adoption of the following resolution:

WHEREAS, P.L.1981, c. 385 (C.52:14-15a) was amended by the Senate and General Assembly of the State of New Jersey to provide that municipalities may provide for mandatory direct deposit of employees' net pay on or after July 1, 2014; and

WHEREAS, this requirement for mandatory direct deposit of net pay will reduce the need for custom check stock, reduce payroll processing time, and eliminate the need and cost of producing and replacing lost checks; and

WHEREAS, the employees of the municipality shall indicate, in writing to the Division of Payroll, the specific banking institution(s) and designated checking account(s), savings account(s) or share account(s) to which the deposit shall be made on behalf of the employee; and

WHEREAS, P.L.1981, c. 385 allows the City to exempt seasonal and temporary employees from the direct deposit requirement;

NOW, THEREFORE BE IT RESOLVED, by the Municipal Council of the City of Jersey City:

1. Effective July 16, 2014, the Division of Payroll shall begin implementing the mandatory direct deposit of net pay for employees of the City of Jersey City to the specific banking institution(s) provided by each employee.
2. Direct deposit shall be mandatory for all employees hired after July 16, 2014
3. Current employees must register for direct deposit prior to the last pay period of 2014.
4. All employee compensation shall be paid using direct deposit.
5. Seasonal and temporary employees may be exempted from direct deposit at the discretion of the Business Administrator.
6. An employee's terminal pay may be in the form of a paper check, at the discretion of the Business Administrator.

APPROVED: _____

APPROVED AS TO LEGAL FORM

APPROVED: _____

Business Administrator

Corporation Counsel

Certification Required

Not Required

APPROVED 9-0

RECORD OF COUNCIL VOTE ON FINAL PASSAGE 7.16.14											
COUNCILPERSON	AYE	NAY	N.V.	COUNCILPERSON	AYE	NAY	N.V.	COUNCILPERSON	AYE	NAY	N.V.
GAJEWSKI	✓			YUN	✓			RIVERA	✓		
RAMCHAL	✓			OSBORNE	✓			WATTERMAN	✓		
BOGGIANO	✓			COLEMAN	✓			LAVARRO, PRES	✓		

✓ Indicates Vote

N.V.-Not Voting (Abstain)

Adopted at a meeting of the Municipal Council of the City of Jersey City N.J.

Rolando R. Lavarro, Jr., President of Council

Robert Byrne, City Clerk

RESOLUTION FACT SHEET – NON-CONTRACTUAL

This summary sheet is to be attached to the front of any resolution that is submitted for Council consideration. Incomplete or vague fact sheets will be returned with the resolution.

Full Title of Ordinance/Resolution

RESOLUTION MANDATING THE USE OF DIRECT DEPOSIT FOR EMPLOYEE PAYCHECKS

Initiator

Department/Division	Administration	Office of the Business Administrator
Name/Title	Robert J. Kakoleski	Business Administrator
Phone/email	201-547-5147	rkakoleski@cnj.org

Note: Initiator must be available by phone during agenda meeting (Wednesday prior to council meeting @ 4:00 p.m.)

Resolution Purpose

P.L.1981, c. 385 (C.52:14-15a) was amended by the Senate and General Assembly of the State of New Jersey to allow municipalities to mandate the direct deposit of employees' net pay on or after July 1, 2014.

Direct deposit reduces processing and printing costs associated with payroll. Going forward, the City will be able to implement web-based employee self-service for paperless delivery of direct deposit information, further reducing processing and printing costs associated with payroll. Implementation will begin immediately and continue through the end of 2014.

Employees who do not have bank accounts will be issued a debit card which will be replenished with their net pay on payday. Seasonal and temporary employees may be exempted from the direct deposit requirement.

I certify that all the facts presented herein are accurate.

Signature of Department Director

Date

7/9/14

Resolution of the City of Jersey City, N.J.

City Clerk File No. Res. 14.472
 Agenda No. 10.E
 Approved: JUL 16 2014
 TITLE:



RESOLUTION CELEBRATING THE 19TH ANNUAL JERSEY CITY CARIBBEAN CARNIVAL, PARADE AND FESTIVAL AND THE JERSEY CITY CARIBBEAN/WEST INDIAN COMMUNITY

WHEREAS, Saturday, July 26, 2014, will be the 19th Annual Jersey City Caribbean Carnival, Parade and Festival to celebrate the heritage, spirit, and achievements of all peoples of Caribbean/West Indian heritage; and

WHEREAS, June is National Caribbean-American Heritage Month, as recognized in a May 30, 2014 Proclamation by President Barack Obama, which acknowledged that "Caribbean Americans have contributed to every aspect of our society — from science and medicine to business and the arts. During National Caribbean-American Heritage Month, we honor their history, culture, and essential role in the American narrative"; and

WHEREAS, the Caribbean Community and Common Market (CARICOM), a collaboration of fifteen (15) Caribbean nations, including its local chapters, allies and affiliates, is dedicated to improvements in the employment, standard of living, economic development and productivity of its members. CARICOM supports the well being and vitality of Caribbean-Americans and seeks to promote Caribbean/West Indian culture and heritage; and

WHEREAS, the Jersey City West Indian/Caribbean-American Carnival/Festival Association, Inc. organizes the annual Caribbean Carnival, Parade and Festival in Jersey City; and

WHEREAS, this year's celebration includes the CARICOM flag raising at City Hall on July 9, 2014 as well as additional festivities on July 26, 2014, including a scholarship breakfast sponsored by Sidewalk University at Battello Waterfront Restaurant; a parade beginning at Lincoln Park and traveling to City Hall; and a festival featuring Caribbean cuisine and crafts at Exchange Place.

NOW, THEREFORE, BE IT RESOLVED, that the Municipal Council of the City of Jersey City does hereby celebrate the 19th Annual Jersey City Caribbean Carnival, Parade and Festival and pays tribute to the achievements and accomplishments of Jersey City residents of Caribbean/West Indian decent.

BE IT FURTHER RESOLVED, that the Municipal Council does hereby urge Jersey City residents of all ethnic backgrounds to participate in the reflection of a day which instills pride in Caribbean and West Indian heritage.

G:\WPDOCSITOLONDAIRESOSIANNIVERSARY\19th Caribbean Carnival, Parade & Festival - Basso for Lavarro & Ramchal.docx

APPROVED: [Signature] APPROVED AS TO LEGAL FORM
 Business Administrator Corporation Counsel

Certification Required
 Not Required

APPROVED 9-0

RECORD OF COUNCIL VOTE ON FINAL PASSAGE 7.16.14											
COUNCILPERSON	AYE	NAY	N.V.	COUNCILPERSON	AYE	NAY	N.V.	COUNCILPERSON	AYE	NAY	N.V.
GAJEWSKI	✓			YUN	✓			RIVERA	✓		
RAMCHAL	✓			OSBORNE	✓			WATTERMAN	✓		
BOGGIANO	✓			COLEMAN	✓			LAVARRO, PRES	✓		

✓ Indicates Vote N.V.-Not Voting (Abstain)

Adopted at a meeting of the Municipal Council of the City of Jersey City N.J.
[Signature] Rolando R. Lavarro, Jr., President of Council
[Signature] Robert Byrne, City Clerk

Resolution of the City of Jersey City, N.J.

City Clerk File No. Res. 14.473
 Agenda No. 10.F
 Approved: JUL 16 2014



TITLE:

RESOLUTION CELEBRATING THE LIFE OF
Robert Steven Foster

JUNE 3, 1956 - JUNE 18, 2014

WHEREAS, Robert Steven Foster was born on June 3, 1956 at Margaret Hague Hospital in Jersey City, New Jersey to Charles and Doris Foster. He was always a gentle charming child whose demeanor earned him the nickname "Smokey." Robert was charming with a good heart and would help anyone in need; and

WHEREAS, Robert attended Adlai E. Stevenson High School in Bronx, NY and studied Psychology at Lehman College in the Bronx. Robert had several jobs in his early years. For the past 20 years, he was a loyal employee at Spring Tech Corporation in the Bronx where everyone became his family; and

WHEREAS, while Robert was a lifelong resident of Bronx New York, he spent most of his time in Jersey City, where he was a member of Monumental Baptist Church. Robert was a voracious reader and talented artist. He was also a big sports fan. His favorite teams were the New York Giants, Yankees, and Knicks. Robert often sat with his mother after church and talked about sports and now she knows more about sports than many sports writers; and

WHEREAS, Robert Steven (Smokey) Foster entered into eternal rest on June 18, 2014. Robert valiantly fought against his illness and was an inspiration even unto death. Surviving to cherish Robert's precious memories are: his devoted parents Charles and Doris Foster, his brother and sister-in-law Daniel Foster and Cynthia, his sister and brother-in-law Glendora Collier and Thomas and his beloved sons Steven, Charles and Jellyn Foster; and

WHEREAS, Robert also leaves to mourn a host of aunts, uncles, cousins, nieces and nephews near and far. He will be greatly missed by many dear friends including his longtime confidant Genie and his Spring Tech Corporation family who always stood by him.

NOW THEREFORE, BE IT RESOLVED, that the Municipal Council of the City of Jersey City deems it fitting and proper to celebrate the life and good deeds of Robert Steven Foster.

G:\WPDOCS\TOLONDA\RESOS\EULOGIZE\Robert Steven Foster.docx

APPROVED: [Signature]
 APPROVED: [Signature]
 Business Administrator

APPROVED AS TO LEGAL FORM
[Signature]
 Corporation Counsel

Certification Required

Not Required

APPROVED 9-0

RECORD OF COUNCIL VOTE ON FINAL PASSAGE 7.16.14											
COUNCILPERSON	AYE	NAY	N.V.	COUNCILPERSON	AYE	NAY	N.V.	COUNCILPERSON	AYE	NAY	N.V.
GAJEWSKI	✓			YUN	✓			RIVERA	✓		
RAMCHAL	✓			OSBORNE	✓			WATTERMAN	✓		
BOGGIANO	✓			COLEMAN	✓			LAVARRO, PRES	✓		

✓ Indicates Vote

N.V.-Not Voting (Abstain)

Adopted at a meeting of the Municipal Council of the City of Jersey City N.J.

[Signature]
 Rolando R. Lavarro, Jr., President of Council

[Signature]
 Robert Byrne, City Clerk

Resolution of the City of Jersey City, N.J.

City Clerk File No. Res. 14.474

Agenda No. 10.6

Approved: JUL 16 2014

TITLE:



AUTHORIZING REPLACEMENT OF LOST THIRD PARTY TAX SALE CERTIFICATES# 2013-1859, 2013-1868, 2013-1879, 2013-1899, 2013-1914, 2013-1925, 2013-2007, 2013-2009, 2013-2035, 2013-2049, 2013-2064, 2013-2079, 2013-2093, 2013-2096, 2013-2102, 2013-2103, 2013-2107, 2013-2108, 2013-2115, 2013-2116, 2013-2120, 2013-2125, 2013-2125, 2013-2134, 2013-2140, 2013-2157, 2013-2209, 2013-2210, 2013-2221, 2013-2235, 2013-2261, 2013-2262, 2013-2264, 2013-2266, 2013-2269, 2013-2271, 2013-2279, 2013-2282, 2013-2298, 2013-2313, 2013-2329, 2013-2383, 2013-2391, 2013-2392, 2013-2429, 2013-2445, 2013-2447, 2013-2456, 2013-2464 SOLD TO PAT CARABELLESE

COUNCIL OFFERED, AND MOVED ADOPTION OF THE FOLLOWING RESOLUTION:

WHEREAS, the City of Jersey City sold tax sale certificates# 2013-1859, 2013-1868, 2013-1879, 2013-1899, 2013-1914, 2013-1925, 2013-2007, 2013-2009, 2013-2035, 2013-2049, 2013-2064, 2013-2079, 2013-2093, 2013-2096, 2013-2102, 2013-2103, 2013-2107, 2013-2108, 2013-2115, 2013-2116, 2013-2120, 2013-2125, 2013-2125, 2013-2134, 2013-2140, 2013-2157, 2013-2209, 2013-2210, 2013-2221, 2013-2235, 2013-2261, 2013-2262, 2013-2264, 2013-2266, 2013-2269, 2013-2271, 2013-2279, 2013-2282, 2013-2298, 2013-2313, 2013-2329, 2013-2383, 2013-2391, 2013-2392, 2013-2429, 2013-2445, 2013-2447, 2013-2456, 2013-2464 to **PAT CARABELLESE** on December 19, 2013; and

WHEREAS, the third party lien holder sent the certificates to the Hudson County Registers Office and the Registers Office mailed the 50 certificates to the wrong address and the certificates are now lost; and

WHEREAS, the Tax Collector would like to issue a duplicate tax sale certificates to **PAT CARABELLESE** under chapter 99 the P.L. of 1997; and

WHEREAS, Hudson County has asked us to prepare the duplicate certificates and to waive the \$100.00 fee for each duplicate due to the error; and

NOW, THEREFORE, BE IT RESOLVED, by the Municipal Council of the City of Jersey City, that **PAT CARABELLESE** is hereby given duplicate tax sale certificates.

APPROVED: [Signature]
 APPROVED: Gregory Corrado
 Business Administrator
 HEST

APPROVED AS TO LEGAL FORM
[Signature]
 Corporation Counsel
 Certification Required
 Not Required

APPROVED 9-0

RECORD OF COUNCIL VOTE ON FINAL PASSAGE 7.16.14											
COUNCILPERSON	AYE	NAY	N.V.	COUNCILPERSON	AYE	NAY	N.V.	COUNCILPERSON	AYE	NAY	N.V.
GAJEWSKI	✓			YUN	✓			RIVERA	✓		
RAMCHAL	✓			OSBORNE	✓			WATTERMAN	✓		
BOGGIANO	✓			COLEMAN	✓			LAVARRO, PRES	✓		

✓ Indicates Vote

N.V.-Not Voting (Abstain)

Adopted at a meeting of the Municipal Council of the City of Jersey City N.J.

[Signature]
 Rolando R. Lavarro, Jr., President of Council

[Signature]
 Robert Byrne, City Clerk

RESOLUTION FACT SHEET – NON-CONTRACTUAL

This summary sheet is to be attached to the front of any resolution that is submitted for Council consideration. Incomplete or vague fact sheets will be returned with the resolution.

Full Title of Ordinance/Resolution

Authorizing Replacement of Lost Third Party Tax Sale Certificates # 2013-1859, 2013-1868, 2013-1879, 2013-1899, 2013-1914, 2013-1925, 2013-2007, 2013-2009, 2013-2035, 2013-2049, 2013-2064, 2013-2079, 2013-2093, 2013-2096, 2013-2102, 2013-2103, 2013-2107, 2013-2108, 2013-2115, 2013-2116, 2013-2120, 2013-2125, 2013-2125, 2013-2134, 2013-2140, 2013-2157, 2013-2209, 2013-2210, 2013-2221, 2013-2235, 2013-2261, 2013-2268, 2013-2261, 2013-2266, 2013-2268, 2013-2271, 2013-2272, 2013-2282, 2013-2282

Initiator

Department/Division	Administration	Tax Collection
Name/Title	Maureen Cosgrove	Tax Collector
Phone/email	5120	Maureen@icnj.org

Note: Initiator must be available by phone during agenda meeting (Wednesday prior to council meeting @ 4:00 p.m.)

Resolution Purpose

The purpose of this resolution is to prepare duplicate tax sale certificates for Pat Carabellese. Hudson County has asked us to prepare the duplicate certificates and to waive the \$100.00 fee for each duplicate due to the error in mailing the certificates back to the lien holder.

I certify that all the facts presented herein are accurate.

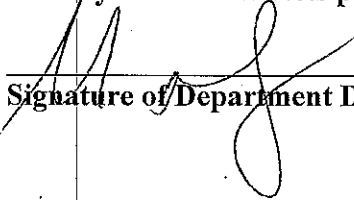

Signature of Department Director

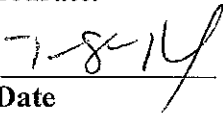

Date



COUNTY OF HUDSON, NEW JERSEY
OFFICE OF THE COUNTY COUNSEL
DEPARTMENT OF LAW
ADMINISTRATION BUILDING ANNEX
567 PAVONIA AVENUE
JERSEY CITY, NJ 07306

(201) 795-6250
Fax: (201) 795-6428

THOMAS A. DeGISE
COUNTY EXECUTIVE

DONATO J. BATTISTA
COUNTY COUNSEL

MARK E. MORCHEL
DEPUTY COUNTY COUNSEL

LOUIS C. ROSEN
DEPUTY COUNTY COUNSEL

Michael L. Dermody
1st Assistant County Counsel

Nell Carroll, Jr.
John Collins
Daniel DeSalvo
Kathleen M. Grant
Susan McCurrie
Robin Moses
Chanima Odoms
Robert J. Pompilano
Daniel W. Sexton
John Smith III
Radames Velazquez, Jr.
Aurelio Vincitore

July 9, 2014

Jeremy Farrell, Corporation Counsel
City of Jersey City
City Hall
280 Grove Street
Jersey City, New Jersey 07302

Investigators
Steve Krywinski
Alvin Sims
Vincent Calabrese

Re: Duplicate Tax Sale Certificates

Dear Mr. Farrell:

A recent issue has been brought to my attention by the Hudson County Register's office. It seems that the Register's office misaddressed an envelope containing 50 tax sale certificates. The tax sale certificates were all issued to the same individual. I have been told that the Jersey City Tax Collector pursuant to the provisions of N.J.S.A. 54:5-52.1 is requesting that \$100.00 per tax sale certificate be paid by the requestor. Given that the need for the issuance of duplicate tax sale certificates was caused by the County, the County is intending to pay for the costs of the issuance of duplicates. In view of the cost, \$5,000.00, and in recognition of the fact that the cost will ultimately be borne by the taxpayers of Hudson County, I would ask Jersey City to either waive the reissuance fees or at least reduce the charges. I believe Maureen Cosgrove, the City Tax Collector, is aware of the issue. Obviously, any consideration the City can give to this request will be greatly appreciated.

Very truly yours,

DONATO J. BATTISTA
Hudson County Counsel

Resolution of the City of Jersey City, N.J.

City Clerk File No. Res. 14.475

Agenda No. 10.H

Approved: JUL 16 2014



TITLE: RESOLUTION REJECTING ALL PROPOSALS FOR THE JERSEY CITY DASHBOARD PROGRAM DATA STORAGE AND ANALYSIS SOFTWARE SYSTEM REQUEST FOR PROPOSALS

COUNCIL OFFERED AND MOVED ADOPTION OF THE FOLLOWING RESOLUTION:

WHEREAS, the City of Jersey City (City) desires to award a contract for licensing of proprietary computer software for the Jersey City Dashboard Program data storage and analysis software system (Dashboard Program); and

WHEREAS, the Dashboard Program will increase transparency by making data and information on City services, activities, and operations readily available to the public through an interactive website; and

WHEREAS, the Dashboard Program will allow City departments, autonomous agencies, and other administrative employees to analyze City services, activities, and operations in an effort to reallocate resources and manpower more efficiently, eliminate wasteful and unnecessary spending, and address inadequate service offerings; and

WHEREAS, N.J.S.A. 40A:11-4.1(a) authorizes the City to use competitive contracting to award a contract for "the purchase or licensing of proprietary computer software"; and

WHEREAS, resolution 14.044 was passed by the Jersey City Municipal Council on January 29, 2014 authorizing the use of competitive contracting to award a contract for the Dashboard Program, in accordance with N.J.S.A. 40A:11-4.3(a); and

WHEREAS, section 21 of P.L.1999, c.440 (C.40A:11-13.2) authorizes the City to reject all proposals if it so desires to make substantial changes to the proposal requirements; and

WHEREAS, the City will issue a new Request for Proposals for the Dashboard Program with substantial changes as soon as practicable, contingent upon rejection of all proposals as set forth in this resolution;

NOW, THEREFORE, BE IT RESOLVED by the Municipal Council of the City of Jersey City that the City rejects all proposals submitted in response to the Dashboard Program Request for Proposals in order to issue a revised Request for Proposals with substantial changes to the proposal requirements.

APPROVED: _____

APPROVED AS TO LEGAL FORM _____

APPROVED: _____
Business Administrator

Corporation Counsel

Certification Required

Not Required

APPROVED 9-0

RECORD OF COUNCIL VOTE ON FINAL PASSAGE 7.16.14											
COUNCILPERSON	AYE	NAY	N.V.	COUNCILPERSON	AYE	NAY	N.V.	COUNCILPERSON	AYE	NAY	N.V.
GAJEWSKI	✓			YUN	✓			RIVERA	✓		
RAMCHAL	✓			OSBORNE	✓			WATTERMAN	✓		
BOGGIANO	✓			COLEMAN	✓			LAVARRO, PRES	✓		

✓ Indicates Vote

N.V.-Not Voting (Abstain)

Adopted at a meeting of the Municipal Council of the City of Jersey City N.J.

Rolando R. Navarro, Jr., President of Council

Robert Byrne, City Clerk

RESOLUTION FACT SHEET – NON-CONTRACTUAL

This summary sheet is to be attached to the front of any resolution that is submitted for Council consideration. Incomplete or vague fact sheets will be returned with the resolution.

Full Title of Ordinance/Resolution

RESOLUTION REJECTING ALL PROPOSALS FOR THE JERSEY CITY DASHBOARD PROGRAM DATA STORAGE AND ANALYSIS SOFTWARE SYSTEM REQUEST FOR PROPOSALS

Initiator

Department/Division	IT Division	Administration Department
Name/Title	Brian Platt	Aide to the Mayor
Phone/email	201-988-2432	BPlatt@jcnj.org

Note: Initiator must be available by phone during agenda meeting (Wednesday prior to council meeting @ 4:00 p.m.)

Resolution Purpose

Rejecting all proposals submitted in response to the Dashboard Program RFP in order to make substantial changes to the RFP.

I certify that all the facts presented herein are accurate.

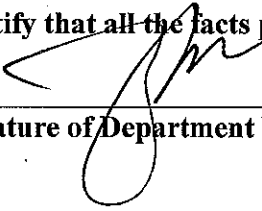

Signature of Department Director

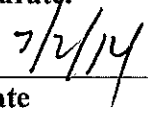

Date

Resolution of the City of Jersey City, N.J.

City Clerk File No. Res. 14.476

Agenda No. 10.I

Approved: JUL 16 2014

TITLE:



RESOLUTION AUTHORIZING MEMBER PARTICIPATION IN THE NATIONAL INTERGOVERNMENTAL PURCHASING ALLIANCE (NIPA) COOPERATIVE PURCHASING SYSTEM

COUNCIL offered and moved adoption of the following resolution:

WHEREAS, N.J.S.A. - 52:34-6.2 authorizes a municipality to enter into cooperative purchasing agreements with one or more other states or political subdivisions for the purchase of goods and services; and

WHEREAS, the National Intergovernmental Purchasing Alliance (NIPA) is a nationally-recognized and accepted cooperative purchasing agreement that was developed utilizing a competitive bidding process; and

WHEREAS, the National Intergovernmental Purchasing Alliance (NIPA) has offered the City of Jersey City (City) the opportunity to participate in a Cooperative Purchasing System for the purchase of goods and services; and

WHEREAS, the City desires to join the National Intergovernmental Purchasing Alliance Cooperative Purchasing System to purchase goods and/or services, to make the procurement process more efficient and to provide cost savings to the City;

NOW, THEREFORE, BE IT RESOLVED, by the Municipal Council of the City of Jersey City that:

1. The Mayor or Business Administrator is authorized to execute the agreement attached hereto to participate in the National Intergovernmental Purchasing Alliance Cooperative Purchasing System; and
2. The City of Jersey City shall ensure that the goods and/or services procured through the system comply with all applicable laws of the State of New Jersey, Local Public Contracts Law N.J.S.A. 40A:11-1 et seq. and all other provisions of the revised statutes of the State of New Jersey.

APPROVED: _____
6/22/14

APPROVED AS TO LEGAL FORM

APPROVED: *[Signature]*
 Business Administrator

[Signature]
 Corporation Counsel

Certification Required

Not Required

APPROVED 9-0

RECORD OF COUNCIL VOTE ON FINAL PASSAGE 7.16.14											
COUNCILPERSON	AYE	NAY	N.V.	COUNCILPERSON	AYE	NAY	N.V.	COUNCILPERSON	AYE	NAY	N.V.
GAJEWSKI	✓			YUN	✓			RIVERA	✓		
RAMCHAL	✓			OSBORNE	✓			WATTERMAN	✓		
BOGGIANO	✓			COLEMAN	✓			LAVARRO, PRES.	✓		

✓ Indicates Vote

N.V.-Not Voting (Abstain)

Adopted at a meeting of the Municipal Council of the City of Jersey City N.J.

[Signature]
 Rolando R. Lavarro, Jr., President of Council

[Signature]
 Robert Byrne, City Clerk

RESOLUTION FACT SHEET - CONTRACT AWARD

This summary sheet is to be attached to the front of any resolution that is submitted for Council consideration. Incomplete or vague fact sheets will be returned with the resolution.

Full Title of Ordinance/Resolution

RESOLUTION AUTHORIZING MEMBER PARTICIPATION IN THE NATIONAL INTERGOVERNMENTAL PURCHASING ALLIANCE (NIPA) COOPERATIVE PURCHASING SYSTEM

Project Manager

Department/Division	DPW	Various Divisions
Name/Title	Hector Ortiz	Deputy Dir of Operations
Phone/email	201-547-4423	Ortizh@jenl.org

Note: Project Manager must be available by phone during agenda meeting (Wednesday prior to council meeting @ 4:00 p.m.)

Contract Purpose

TO ACQUIRE GOODS AND SERVICES THROUGH STATE APPROVED PURCHASING COOPERATIVE. THE DEPARTMENT OF PUBLIC WORKS/PARKS DIVISION HAS IDENTIFIED THE NEED FOR GROUNDS MAINTENANCE EQUIPMENT AND SUPPLIES THAT CAN BE ACQUIRED AT A SIGNIFICANT COST SAVINGS THROUGH THIS PURCHASING COOPERATIVE. THAT IS THE REASON WE WISH TO JOIN.

Cost (Identify all sources and amounts)

NONE

Contract term (include all proposed renewals)

N/A

Type of award N/A

If "Other Exception", enter type

Additional Information

I certify that all the facts presented herein are accurate.

Signature of Department Director

6/27/14
Date

Signature of Purchasing Director

6/27/14
Date

Division of Purchasing

Your National IPA Participating Agency Number:

1189345

Your Dedicated National IPA Representative:

Stephen Maxwell

(732) 608-4403

stephen.maxwell@nationalipa.org

Hello Peter

Your participation form has been received and processed. Congratulations! You are now eligible to access and utilize all the competitively solicited and publicly awarded agreements available through National IPA.

Details for all awarded contracts, as well as contracts in process and under evaluation are available at www.nationalipa.org/agreements.

If you need additional information or assistance with any of the National IPA master agreements, please contact your dedicated National IPA Regional Manager or contact National IPA Customer Relations at 866-408-3077 or info@nationalipa.org.

Thank you for your participation and we look forward to serving you and your organization.



National IPA Contracting Process



National IPA Team

MASTER INTERGOVERNMENTAL COOPERATIVE PURCHASING AGREEMENT

This agreement is made between certain government agencies that execute a Principal Procurement Agency Certificate ("Principal Procurement Agencies") to be appended and made a part hereof and other public agencies ("Participating Public Agencies") that register electronically with National Intergovernmental Purchasing Alliance Company ("National IPA") or otherwise execute a Participating Public Agency Certificate to be appended and made a part hereof.

RECITALS

WHEREAS, after a competitive bidding and selection process by Principal Procurement Agencies, a number of Suppliers have entered into Master Agreements to provide a variety of goods, products and services based on national volumes (herein "Products");

WHEREAS, Master Agreements are made available by Principal Procurement Agencies through National IPA and provide that Participating Public Agencies may purchase Products on the same terms, conditions and pricing as the Principal Procurement Agency, subject to any applicable local purchasing ordinances and the laws of the State of purchase;

NOW, THEREFORE, in consideration of the mutual promises contained in this agreement, and of the mutual benefits to result, the parties agree as follows:

1. That each party will facilitate the cooperative procurement of Products.
2. That the procurement of Products subject to this agreement shall be conducted in accordance with and subject to the relevant statutes, ordinances, rules and regulations that govern each party's procurement practices.
3. That the cooperative use of bids obtained by a party to this agreement shall be in accordance with the terms and conditions of the bid, except as modification of those terms and conditions is otherwise allowed or required by applicable law.
4. That the Principal Procurement Agencies will make available, upon reasonable request and subject to convenience, information which may assist in improving the procurement of products by the Participating Public Agencies.
5. That a procuring party will make timely payments to the Supplier for Products received in accordance with the terms and conditions of the procurement. Payment for Products and inspections and acceptance of Products ordered by the procuring party shall be the exclusive obligation of such procuring party. Disputes between procuring party and Supplier are to be resolved in accord with the law and venue rules of the State of purchase.
6. The procuring party shall not use this agreement as a method for obtaining additional concessions or reduced prices for similar products or services.
7. The procuring party shall be responsible for the ordering of Products under this agreement. A non-procuring party shall not be liable in any fashion for any violation by a procuring party, and the procuring party shall hold non-procuring party harmless from any liability that may arise from action or inaction of the procuring party.
8. This agreement shall remain in effect until termination by a party giving 30 days written notice to the other party. The provisions of paragraphs 5, 6 and 7 hereof shall survive any such termination.
9. This agreement shall take effect after execution of the Principal Procurement Agency Certificate or Participating Public Agency Registration, as applicable.

LFN 2011-35

November 28, 2011

Contact Information

Director's Office

V. 609.292.6613
F. 609.292.9073

Local Government Research

V. 609.292.6110
F. 609.292.9073

**Financial Regulation
and Assistance**

V. 609.292.4806
F. 609.984.7388

Local Finance Board

V. 609.292.0479
F. 609.633.6243

Local Management Services

V. 609.292.7842
F. 609.633.6243

Authority Regulation

V. 609.984.0132
F. 609.984.7388

Mail and Delivery

101 South Broad St.
PO Box 803
Trenton, New Jersey
08625-0803

Web: www.nj.gov/dca/lgs

E-mail: dlgs@dca.state.nj.us

Distribution

County and Municipal Clerks
and Chief Financial Officers
Local Authority and Fire
District Boards of
Commissioners
School Business Officials
Local Procurement Officials

Local Finance Notice

Chris Christie
Governor

Kim Guadagno
Lt. Governor

Lori Grifa
Commissioner

Thomas H. Neff
Director

Guidance on Use of New Law Regarding National Contracts

Recently Governor Christie enacted P.L.2011, c.139 into law. This law affects public contracting laws for all government contracting agencies by permitting agencies to use contracts awarded by "national" or "regional" cooperatives or other states that were competitively bid. The law supplements existing law on the use of such contracts and is intended to provide additional flexibility to local government in the area of procurement.

Appropriate State agencies are reviewing the new law and the Division of Local Government Services intends to issue additional guidance in the near future.

Until then, contracting units should proceed with prudence to ensure their actions are compliant with the law. Pending additional guidance, contracting units should take into account the following as local circumstances dictate.

1. In applying the law, consider that there is no stated intent that NJ businesses should be put at a disadvantage because of differences between NJ public contracting law and that of jurisdictions that awarded the cooperative contract.
2. Local procurement procedures should continue to ensure the public trust. Laws relating to disclosure of political contributions, non-collusion, and ethics should continue to be followed.
3. Contracting officials should be cautious to ensure that the new authority is not abused. Local officials continue to have responsibility to choose vendors in an open and transparent manner to ensure public confidence in the integrity of government spending. Further, if a national contract is used, membership and participation rules of the national cooperative should be reviewed and followed.

4. Best practices should include ensuring that pricing under the national model is competitive and that economy in the form of low pricing is not unduly compromised by the possible of efficiency of national contractors. To that extent, contracting units should review State and local cooperative system contracts to see if there other available contracts that provide lower prices.
5. When using online ordering systems, local officials must establish and maintain internal controls to ensure quote and bid thresholds are maintained, encumbrances are established, purchases are documented, and there is an audit trail. Procurement and fiscal staff are reminded that all purchases with a dollar volume over the contracting units bid threshold require award by the governing body.
6. The new law does not make changes to previous law concerning U.S. General Services Administration Federal Supply Contracts. GSA/FSS contract use is not authorized by contracting units unless the contracts are issued as State contracts by the Division of Purchase and Property (N.J.A.C. 17:12-1A.5). While it is possible that some GSA/FSS vendors are part of national cooperative contracts and contracts may be available through them, the new law does not change the existing limits on GSA contracts.
7. Contracting units that previously awarded contracts for goods or services that may be covered by a national cooperative contract are obligated to fulfill those contracts until they expire. Using a national contract in the presence of an awarded contract could constitute a charge of breach of contract by that vendor.

The vendor community will be bringing the new law to the attention of contracting units. Contracting officials choosing to move forward with such purchases in advance of additional guidance should carefully review vendor claims of compliance with the new law with their legal advisors to ensure they are consistent with the law.

The Division appreciates that this law is new and potentially creates a wide range of new procurement sources. Contracting unit officials should act prudently pending issuance of further guidance.

Approved: Thomas H. Neff, Director

Table of Web Links

Page	Shortcut text	Internet Address
1	P.L.2011, c.139	www.njleg.state.nj.us/2010/Bills/AL11/139.PDF

Resolution of the City of Jersey City, N.J.

City Clerk File No. Res. 14.477

Agenda No. 10.J

Approved: JUL 16 2014



TITLE: **RESOLUTION AUTHORIZING THE SETTLEMENT OF THE SUIT OF SERAFINA SENGCO v. CITY OF JERSEY CITY, ET AL.**

NOW, THEREFORE BE IT RESOLVED, by the Municipal Council of the City of Jersey City that:

WHEREAS, Serafina Sengco ("Sengco" or "Plaintiff") having filed suit against the City of Jersey City, et al. in Superior Court of New Jersey, Hudson County, entitled Serafina Sengco v. City of Jersey City, et al., bearing Docket No. HUD-L-3056-13 (the "Lawsuit"); and

WHEREAS, the Complaint alleges that Defendants discriminated against Plaintiff on the basis of her age and retaliated against her for complaining about said age discrimination; and

WHEREAS, because of the litigation risk involved, the Corporation Counsel has recommended a settlement that: (1) bridges the gap in Sengco's 29 years of service to the City of Jersey City and grants her all rights and privileges of "eligible employees" pursuant to Jersey City Municipal Code §§ 53-12 and 53-13 for her more than 25 years of service to the City of Jersey City; and (2) pays Sengco's attorneys' fees and costs of \$30,000 and all applicable mediation fees and costs; and

WHEREAS, Plaintiff has agreed to this settlement and will sign all required releases and a Stipulation of Dismissal with Prejudice; and

WHEREAS, the necessary funds for this settlement are available in the City of Jersey City Insurance Fund Commission Accounts.

NOW, THEREFORE, BE IT RESOLVED by the Municipal Council of the City of Jersey City, that:

1. The Corporation Counsel be authorized to settle this lawsuit and: (1) credit Sengco for her 25 years of service to the City of Jersey City and grant her all rights and privileges of "eligible employees" pursuant to Jersey City Municipal Code §§ 53-12 and 53-13; (2) pay Sengco's attorneys' fees and costs of \$30,000 and all applicable mediation fees and costs.
2. The Jersey City Insurance Fund Commission is authorized to issue a check in the amount of \$30,000 payable to Plaintiff's attorney.
3. Sengco is hereby granted credit for her 25 years of service to the City of Jersey City and grant her all rights and privileges of "eligible employees" pursuant to Jersey City Municipal Code §§ 53-12 and 53-13.

I hereby certify that funds for this expenditure are available in the City of Jersey City Insurance Fund Commission Accounts.

Insurance Fund Commissioner

MM/dc
7/9/14

APPROVED: _____

APPROVED AS TO LEGAL FORM

APPROVED: [Signature]
Business Administrator

[Signature]
Corporation Counsel

Certification Required

Not Required

APPROVED 9-0

RECORD OF COUNCIL VOTE ON FINAL PASSAGE 7.16.14											
COUNCILPERSON	AYE	NAY	N.V.	COUNCILPERSON	AYE	NAY	N.V.	COUNCILPERSON	AYE	NAY	N.V.
GAJEWSKI	✓			YUN	✓			RIVERA	✓		
RAMCHAL	✓			OSBORNE	✓			WATTERMANN	✓		
BOGGIANO	✓			COLEMAN	✓			LAVARRO, PRES	✓		

✓ Indicates Vote

N.V.-Not Voting (Abstain)

Adopted at a meeting of the Municipal Council of the City of Jersey City N.J.

[Signature]
Rolando R. Lavarro, Jr., President of Council

[Signature]
Robert Byrne, City Clerk

RESOLUTION FACT SHEET – NON-CONTRACTUAL

This summary sheet is to be attached to the front of any Resolution that is submitted for Council consideration. Incomplete or vague fact sheets will be returned with the Resolution.

Full Title of Resolution

RESOLUTION AUTHORIZING THE SETTLEMENT OF THE SUIT OF SENGCO V. CITY OF JERSEY CITY, ET AL.

Initiator

Department/Division	Law Department	
Name/Title	Jason Watson	
Phone/email	4701/jwatson@jenj.org	

Note: Initiator must be available by phone during agenda meeting (Wednesday prior to council meeting @ 4:00 p.m.)

Resolution Purpose

To resolve the matter of Serafina Sengco v. City of Jersey City et al., bearing Docket No. HUD-L-3056-13.

I certify that all the facts presented herein are accurate.

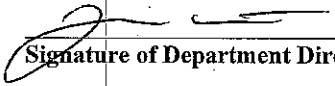
Signature of Department Director

7.9.14
Date

Resolution of the City of Jersey City, N.J.

City Clerk File No. Res. 14.478
 Agenda No. 10.K
 Approved: JUL 16 2014



TITLE: **RESOLUTION AUTHORIZING THE SETTLEMENT OF THE SUIT OF GE CAPITAL INFORMATION TECHNOLOGY V. CITY OF JERSEY CITY, ET AL.**

COUNCIL offered and moved adoption of the following Resolution:

NOW, THEREFORE BE IT RESOLVED, by the Municipal Council of the City of Jersey City that:

WHEREAS, GE Capital Information Technology Solutions having filed suit against the City of Jersey City, et al. in United States District Court, Civil Case No13-cv-03041-SRC-CLW; and

WHEREAS, Synnex Corporation, having filed a counterclaim against the City of Jersey City in the United States District Court, Civil Case No13-cv-03041-SRC-CLW; and

WHEREAS, the Complaint and counterclaims allege that the City of Jersey City breached the two contracts entered for reprographic equipment (copiers); and

WHEREAS, the Corporation Counsel has recommended a settlement in the amount of \$335,000 because of the litigation risk involved; and

WHEREAS, \$190,000 would be payable to plaintiff GE Capital Information Technology and \$145,000 would be payable to third-party defendant Synnex Corporation; and

WHEREAS, the parties have agreed to this settlement and will sign all required releases and stipulations of dismissal; and

WHEREAS, the necessary funds for this settlement are available in Account No.: 01-203-31-433-304

NOW THEREFORE, BE IT RESOLVED by the Municipal Council of the City of Jersey City that:

- I. The Corporation Counsel be authorized to settle this lawsuit for \$335,000.00.
 - a. The Business Administrator is hereby authorized to issue a check in the amount of \$190,000.00 to plaintiff, GE Capital Information Technology.
 - b. The Business Administrator is hereby authorized to issue a check in the amount of \$145,000.00 to third-party defendant, Synnex Corporation.

I hereby certify that funds for this expenditure are available in Account 01-203-31-433-304.

Donna Mauer, Chief Financial Officer

ZE/meg
 July 9, 2014

APPROVED:
 Business Administrator

APPROVED AS TO LEGAL FORM

 Corporation Counsel

Certification Required

Not Required

APPROVED 9-0

RECORD OF COUNCIL VOTE ON FINAL PASSAGE 7.16.14											
COUNCILPERSON	AYE	NAY	N.V.	COUNCILPERSON	AYE	NAY	N.V.	COUNCILPERSON	AYE	NAY	N.V.
GAJEWSKI	✓			YUN	✓			RIVERA	✓		
RAMCHAL	✓			OSBORNE	✓			WATTERMAN	✓		
BOGGIANO	✓			COLEMAN	✓			LAVARRO, PRES	✓		

✓ Indicates Vote

N.V.-Not Voting (Abstain)

Adopted at a meeting of the Municipal Council of the City of Jersey City N.J.

Rolando R. Lavarro, Jr., President of Council

Robert Byrne, City Clerk

RESOLUTION FACT SHEET - NON CONTRACTUAL

This summary sheet is to be attached to the front of any resolution that is submitted for Council Consideration. Incomplete or vague fact sheets will be returned with the resolution.

Full Title of Ordinance/Resolution

RESOLUTION AUTHORIZING THE SETTLEMENT OF THE SUIT OF GE CAPITAL V. CITY OF JERSEY CITY

Initiator

Department/Division	Law Department	Law Department
Name/Title	Jason T. Watson	Assistant Corporation Counsel
Phone/email	(201) 547-4810	jwatson@jcnj.org

Note: Initiator must be available by phone during the agenda meeting (Wednesday prior to council meeting @ 4:00 p.m.)

Resolution Purpose

To settle the above-referenced lawsuit for \$335,000.00.

I certify that all the facts presented herein are accurate

Signature of Department Director

7.9.14
Date

Resolution of the City of Jersey City, N.J.

City Clerk File No. Res. 14.479

Agenda No. 10.L

Approved: JUL 16 2014

TITLE:



RESOLUTION INSTITUTING A COMMITTEE TO REVIEW THE POSSIBILITY OF CREATING A CITY-WIDE CAR-SHARING PROGRAM

COUNCIL Offered and moved adoption of the following Resolution:

WHEREAS, in recent years, the precedent for city-wide car-sharing programs has been set by several cities; and

WHEREAS, on-street parking has become an increasingly stressed resource in the City of Jersey City; and

WHEREAS, several studies have shown that by strategically placing car-sharing vehicles (CSV) in residential areas where driving is not critical, for example in areas where cars are not used to commute to work, the need for owning a car drops significantly as these vehicles provide a convenient alternative to non-regular use; and

WHEREAS, according to the United States Census Bureau's just released American Community Survey 62.4% of the residents of Jersey City use public transportation, carpool or walk; and,

WHEREAS, many consumers who use CSV's in other municipalities see a dramatic decrease in household expenses; and

WHEREAS, the Jersey City Municipal Council believes that creating a car-sharing program in the City of Jersey City will dampen the need for on-street parking and reduce traffic congestions.

NOW, THEREFORE, BE IT RESOLVED by the Municipal Council of the City of Jersey City that:

1. A committee is to be created to produce a report on the viability on the creation of a city-wide car-sharing program.
2. This committee should consist of a designee from the Mayor, 2 designees from the Municipal Council of the City of Jersey City, a designee from the Business Administrator, a designee from the Division of City Planning, and a designee from the Division of Architecture, Engineering, Traffic and Transportation.

APPROVED: _____

APPROVED: _____
Business Administrator

APPROVED AS TO LEGAL FORM

Corporation Counsel

Certification Required

Not Required

APPROVED 9-0

RECORD OF COUNCIL VOTE ON FINAL PASSAGE 7.16.14											
COUNCILPERSON	AYE	NAY	N.V.	COUNCILPERSON	AYE	NAY	N.V.	COUNCILPERSON	AYE	NAY	N.V.
GAJEWSKI	✓			YUN	✓			RIVERA	✓		
RAMCHAL	✓			OSBORNE	✓			WATTERMAN	✓		
BOGGIANO	✓			COLEMAN	✓			LAVARRO, PRES	✓		

✓ Indicates Vote

N.V.-Not Voting (Abstain)

Adopted at a meeting of the Municipal Council of the City of Jersey City N.J.

Rolando R. Lavarro, Jr., President of Council

Robert Byrne, City Clerk

ORDINANCE FACT SHEET – NON-CONTRACTUAL

This summary sheet is to be attached to the front of any Ordinance that is submitted for Council consideration. Incomplete or vague fact sheets will be returned with the Ordinance.

Full Title of Ordinance

RESOLUTION INSTITUTING A COMMITTEE TO REVIEW THE POSSIBILITY OF CREATING A CITY-WIDE CAR-SHARING PROGRAM

Initiator

Department/Division	Municipal Council	
Name/Title	Khemraj Ramchal / David Donnelly	
Phone/email		

Note: Initiator must be available by phone during agenda meeting (Wednesday prior to council meeting @ 4:00 p.m.)

Ordinance Purpose

Several studies have shown that by strategically placing car-sharing vehicles (CSV) in residential areas where driving is not critical, for example in areas where cars are not used to commute to work, the need for owning a car drops significantly as these vehicles provide a convenient alternative to non-regular use.

This resolution creates a committee to review the viability of creating a city-wide CSV program.

I certify that all the facts presented herein are accurate.

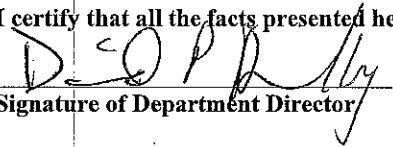
Signature of Department Director

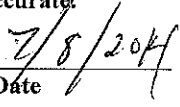
Date

Resolution of the City of Jersey City, N.J.

City Clerk File No. Res. 14.480

Agenda No. 10.M

Approved: JUL 16 2014

TITLE:



**RESOLUTION AUTHORIZING THE JERSEY CITY POLICE DEPARTMENT TO
ACCEPT FUNDS UNDER THE FY 14 EDWARD BYRNE MEMORIAL JUSTICE
ASSISTANCE GRANT (JAG) STATE PROGRAM THROUGH THE HUDSON
COUNTY PROSECUTORS OFFICE**

COUNCIL AS A WHOLE, offered and moved adoption of the following Resolution;

WHEREAS, the Municipal Council of the City of Jersey City has approved a Resolution to apply for funds under Res. # 14-362 dated May 28, 2014

WHEREAS, the City of Jersey City Department of Police has applied and submitted an application for funding to the Hudson County Prosecutor's Office and they submitted a consolidated application for all Hudson County law enforcements agencies;

WHEREAS, the Hudson County Prosecutors Office has confirmed that Jersey City will receive an allocation of \$198,505.00

WHEREAS, The Jersey City Police Department will utilize \$198,505.00 for the continuation of foot and vehicular patrols that will address quality of life complaints, under cover tactical gang - and drug enforcement operations.

NOW THEREFORE, BE IT RESOLVED, by the Municipal Council of the City of Jersey City that:

- The Jersey City Police Department is hereby authorized to accept funding from the FY 14 Edward Byrne Memorial Justice Assistance Grant (JAG) State Program through the Hudson County Prosecutors Office

APPROVED: _____

APPROVED AS TO LEGAL FORM

APPROVED: _____

Business Administrator

Corporation Counsel

Certification Required

Not Required

APPROVED 9-0

RECORD OF COUNCIL VOTE ON FINAL PASSAGE 7.16.14											
COUNCILPERSON	AYE	NAY	N.V.	COUNCILPERSON	AYE	NAY	N.V.	COUNCILPERSON	AYE	NAY	N.V.
GAJEWSKI	✓			YUN	✓			RIVERA	✓		
RAMCHAL	✓			OSBORNE	✓			WATTERMAN	✓		
BOGGIANO	✓			COLEMAN	✓			LAVARRO, PRES	✓		

✓ Indicates Vote

N.V.-Not Voting (Abstain)

Adopted at a meeting of the Municipal Council of the City of Jersey City N.J.

Rolando R. Lavarro, Jr., President of Council

Robert Byrne, City Clerk

RESOLUTION FACT SHEET – NON-CONTRACTUAL

This summary sheet is to be attached to the front of any resolution that is submitted for Council consideration. Incomplete or vague fact sheets will be returned with the resolution.

Full Title of Ordinance/Resolution

RESOLUTION AUTHORIZING THE JERSEY CITY POLICE DEPARTMENT TO ACCEPT FUNDS UNDER THE FY 14 EDWARD BYRNE MEMORIAL JUSTICE ASSISTANCE GRANT (JAG) STATE PROGRAM THROUGH THE HUDSON COUNTY PROSECUTORS OFFICE

Initiator

Department/Division	Police Department	Grants
Name/Title	Elyse Gibbs	Supervising Analyst Grant Applications Program Monitor
Phone/email	201-547-5413 or 862-754-1820	ejgibbs@njcps.org

Note: Initiator must be available by phone during agenda meeting (Wednesday prior to council meeting @ 4:00 p.m.)

Resolution Purpose

Authorization to accept funds under the FY 14 Edward Byrne Memorial Justice Assistance Grant (JAG) State Program in the amount of \$198,505.00 to continue and extend foot and vehicular patrols that will improve quality of life of constituents throughout various neighborhoods and hot spots in Jersey City by conducting overtime details

There is no match requirement for this grant program

I certify that all the facts presented herein are accurate.

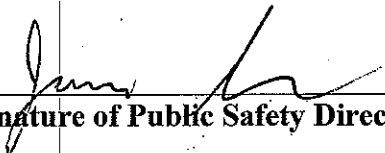
Signature of Public Safety Director

6/16/2014
Date

Resolution of the City of Jersey City, N.J.

City Clerk File No. Res. 14.481

Agenda No. 10.N

Approved: JUL 16 2014

TITLE:



RESOLUTION AUTHORIZING THE OFFICE OF CENTRALIZED GRANTS AND COMMUNITY PARTNERSHIP OFFICE TO APPLY FOR FUNDS FROM THE NEW JERSEY DEPARTMENT OF COMMUNITY AFFAIRS UNDER THE FY 2014 RECREATIONAL OPPORTUNITIES FOR INDIVIDUALS WITH DISABILITIES (ROID) GRANT PROGRAM

COUNCIL Offered and moved adoption of the
following resolution.

WHEREAS, there is a need to provide recreation and leisure services for individuals with disabilities in the City of Jersey; and

WHEREAS, the Recreational Opportunities for Individuals with Disabilities (ROID) Grant support projects that will provide these services to people with disabilities in our community by offering the Recreational Opportunities for Individuals with Disabilities (ROID) Grant Program; and

WHEREAS, the Department of Community Affairs requires a 20% Cash match (\$4,000.00) which can be covered with salary paid to direct recreation program staff working with individuals with disabilities; and;

WHEREAS, the Jersey City Department of Recreation wishes to continue providing services for individuals with disabilities in need with these services being offered under this grant program; and

WHEREAS, the Jersey City Centralized Grants and Community Partnership Office desires to submit a grant application to the Department of Community Affairs on behalf of the Jersey City Department of Recreation for the FY 2014 Recreational Opportunities for Individuals with Disabilities (ROID) Grant Program in the amount of \$20,000.00 with the stipulation that the City will meet the 20% (\$4,000.00) match requirement through salary already paid to direct program staff for a total project cost of \$24,000.00 ; and

NOW, THEREFORE, BE IT RESOLVED by the Municipal Council of the City of Jersey City that:

1. The City of Jersey City authorizes the submission of the grant for funding; and
2. These funds will be used by the Jersey City Department of Recreation to provide services for individuals with disabilities.

APPROVED: 

APPROVED AS TO LEGAL FORM

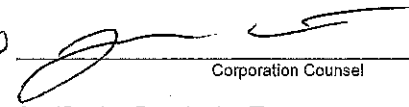
APPROVED: 

Business Administrator

Corporation Counsel

Certification Required

Not Required

APPROVED 9-0

RECORD OF COUNCIL VOTE ON FINAL PASSAGE 7.16.14											
COUNCILPERSON	AYE	NAY	N.V.	COUNCILPERSON	AYE	NAY	N.V.	COUNCILPERSON	AYE	NAY	N.V.
GAJEWSKI	✓			YUN	✓			RIVERA	✓		
RAMCHAL	✓			OSBORNE	✓			WATTERMAN	✓		
BOGGIANO	✓			COLEMAN	✓			LAVARRO, PRES	✓		

✓ Indicates Vote

N.V.-Not Voting (Abstain)

Adopted at a meeting of the Municipal Council of the City of Jersey City N.J.

Rolando R. Lavarro, Jr., President of Council

Robert Byrne, City Clerk

RESOLUTION FACT SHEET – NON-CONTRACTUAL

This summary sheet is to be attached to the front of any resolution that is submitted for Council consideration. Incomplete or vague fact sheets will be returned with the resolution.

Full Title of Ordinance/Resolution

RESOLUTION AUTHORIZING THE OFFICE OF CENTRALIZED GRANTS AND COMMUNITY PARTNERSHIP OFFICE TO APPLY FOR FUNDS FROM THE NEW JERSEY DEPARTMENT OF COMMUNITY AFFAIRS UNDER THE FY 2014 RECREATIONAL OPPORTUNITIES FOR INDIVIDUALS WITH DISABILITIES (ROID) GRANT PROGRAM

Initiator

Department/Division	Recreation Department	Grants
Name/Title	Ryan Strother	Director
Phone/email	201-547-4446	rstrother@cnj.org

Note: Initiator must be available by phone during agenda meeting (Wednesday prior to council meeting @ 4:00 p.m.)

Resolution Purpose

The purpose of this application is to apply for funding to provide services that will benefit individuals with disabilities through providing recreational activities, and group outings.
This grant has a \$4000.00 cash match.

I certify that all the facts presented herein are accurate.



Signature of Recreation Director

6/27/14

Date



Grant Application Approval Form

State Federal Formula Competitive Community Grant

Application Deadline: July 3, 2014

Name of Grant: Recreational Opportunities for Individuals with disabilities (ROID)

Grantor: New Jersey Department of Community Affairs

Grant Period: July 1, 2014 through June 30, 2015

Estimated Award Amount (if known): \$20,000.00

Matching Requirement: No Yes 20% CASH MATCH

Proposed Utilization of Funds:

- Overtime Salaries Salaries Sworn Non-Sworn
- Equipment Information Technology
- Commodities Other Transportation
- Supplies

Comments:

20% match will come from salaries already paid to recreation staff members associated with ROID services

Authorized Signatures:

Submitted by: _____	Approve/Disapprove	Date _____
Recreation Director: <u>[Signature]</u>	Approve/Disapprove	Date <u>6/27/14</u>
Chief Financial Officer: <u>[Signature]</u>	Approve/Disapprove	Date <u>7/7/14</u>

Resolution of the City of Jersey City, N.J.

City Clerk File No. Res. 14.482
 Agenda No. 10.0
 Approved: JUL 16 2014



TITLE:

**RESOLUTION AUTHORIZING AN AGREEMENT WITH THE STATE OF NEW JERSEY,
 DEPARTMENT OF ENVIRONMENTAL PROTECTION, GREEN ACRES ENABLING
 RESOLUTION**

WHEREAS, the New Jersey Department of Environmental Protection, Green Acres Program ("State"), provides loans and/or grants to municipal and county governments and grants to nonprofit organizations for assistance in the acquisition and development of lands for outdoor recreation and conservation purposes; and

WHEREAS, the City of Jersey City desires to further the public interest by obtaining funding in the amount of \$1,000,000.00 from the State to fund the following project Berry Lane Park- Phase IV at a cost of \$2,000,000.00; and

NOW, THEREFORE, the governing body/board resolves that Donna Mauer or the successor to the office of Chief Financial Officer is hereby authorized to:

- (a) make application for such a loan and/or such a grant,
- (b) provide additional application information and furnish such documents as may be required, and
- (c) act as the authorized correspondent of the above named applicant; and

WHEREAS, the State shall determine if the application is complete and in conformance with the scope and intent of the Green Acres Program, and notify the applicant of the amount of the funding award; and

WHEREAS, the applicant is willing to use the State's funds in accordance with such rules, regulations and applicable statutes, and is willing to enter into an agreement with the State for the above named project;

NOW, THEREFORE, BE IT FURTHER RESOLVED, by the Municipal Council Of The City Of Jersey City that:

1. That the Mayor and/or Business Administrator of the above named body or board is hereby authorized to execute an agreement and any amendment thereto with the State known as Berry Lane Development and;
2. That the applicant has its matching share of the project, if a match is required, in the amount of \$1,000,000.00;
3. That, in the event the State's funds are less than the total project cost specified above, the applicant has the balance of funding necessary to complete the project;
4. That the applicant agrees to comply with all applicable federal, state, and local laws, rules, and regulations in its performance of the project; and
5. That this resolution shall take effect immediately.

APPROVED: Donna Mauer CFO

APPROVED AS TO LEGAL FORM

APPROVED: Gregory A. Lavarro
 Business Administrator

[Signature]
 Corporation Counsel

Certification Required

Not Required

APPROVED 9-0

RECORD OF COUNCIL VOTE ON FINAL PASSAGE											
				7.16.14							
COUNCILPERSON	AYE	NAY	N.V.	COUNCILPERSON	AYE	NAY	N.V.	COUNCILPERSON	AYE	NAY	N.V.
GAJEWSKI	✓			YUN	✓			RIVERA	✓		
RAMCHAL	✓			OSBORNE	✓			WATTERMAN	✓		
BOGGIANO	✓			COLEMAN	✓			LAVARRO, PRES	✓		

✓ Indicates Vote

N.V.-Not Voting (Abstain)

Adopted at a meeting of the Municipal Council of the City of Jersey City N.J.

[Signature]
 Rolando R. Lavarro, Jr., President of Council

[Signature]
 Robert Byrne, City Clerk

RESOLUTION FACT SHEET - CONTRACT AWARD

This summary sheet is to be attached to the front of any resolution that is submitted for Council consideration. Incomplete or vague fact sheets will be returned with the resolution.

Full Title of Ordinance/Resolution

RESOLUTION AUTHORIZING AN AGREEMENT WITH THE STATE OF NEW JERSEY, DEPARTMENT OF ENVIRONMENTAL PROTECTION, GREEN ACRES ENABLING RESOLUTION

Project Manager

Department/Division	Business Administration	Grant's Office
Name/Title	Alisha Powers	Sr. Fiscal Analyst
Phone/email	(201)547-5296 or (201)312-9606	apowers@cnj.org

Note: Project Manager must be available by phone during agenda meeting (Wednesday prior to council meeting @ 4:00 p.m.)

Contract Purpose

Development of outdoor land for recreation and conservation for Berry Lane Park Phase IV.

Cost (Identify all sources and amounts)

Green Acres Grant \$1,000,000.00
Local Match \$1,000,000.00

Contract term (include all proposed renewals)

Type of award

Grant Application

If "Other Exception", enter type

Additional Information

I certify that all the facts presented herein are accurate.

Alisha Powers
Signature of Department Director

7/8/14
Date

CERTIFICATION

I, _____ Robert Byrne, City Clerk, do hereby certify that the foregoing is a true copy of a resolution adopted by the Municipal Council of the City of Jersey City at a meeting held on the day of _____, _____.

IN WITNESS WHEREOF, I have hereunder set my hand and the official seal of this body this ____ day of _____, _____.

Resolution of the City of Jersey City, N.J.

City Clerk File No. Res. 14.483

Agenda No. 10.P

Approved: JUL 16 2014



TITLE: RESOLUTION AUTHORIZING THE EXECUTION OF AN AGREEMENT BETWEEN THE JERSEY CITY EMPLOYMENT AND TRAINING PROGRAM AND THE CITY OF JERSEY CITY FOR THE LICENSING OF THE USE OF USED OFFICE FURNITURE

WHEREAS, pursuant to City Resolution 14.110 adopted on February 26, 2014, the City accepted a gift of certain used office furniture from Mack-Cali Realty Corporation; and

WHEREAS, the Jersey City Employment Training Program ("JCETP") is a duly incorporated quasi-public nonprofit organization, whose public purposes include the provision of educational and social services to those in need; and

WHEREAS, JCETP is moving to a refurbished property within the Martin Luther King HUB and is in need of office furniture so that it can complete its nonprofit mission at the HUB; and

WHEREAS, pursuant to N.J.S.A. 40A:12-21.1 and N.J.S.A. 40A:12-21(k), the City is planning to convey personal property, attached as an Exhibit hereto (the "Furniture"), that it no longer needs for municipal purposes to a nonprofit organization which includes among its principal purposes the provision of educational or social services to the public; and

WHEREAS, the City finds it more cost effective to deliver the Furniture to the refurbished property within the Martin Luther King HUB currently leased, and to be occupied by, the JCETP prior to conveying the furniture to the JCETP;

NOW, THEREFORE, BE IT RESOLVED by the Municipal Council of the City of Jersey City, that:

1. The Mayor or Business Administrator is authorized to execute an agreement with the JCETP licensing the acceptance and use of the Furniture.
2. Subject to such modification as may be required or deemed necessary or appropriate by Corporation Counsel, the agreement shall be in substantially the form of the agreement attached hereto.

APPROVED: _____

APPROVED AS TO LEGAL FORM

APPROVED: _____

Business Administrator

Corporation Counsel

Certification Required

Not Required

APPROVED 9-0

RECORD OF COUNCIL VOTE ON FINAL PASSAGE 7.16.14											
COUNCILPERSON	AYE	NAY	N.V.	COUNCILPERSON	AYE	NAY	N.V.	COUNCILPERSON	AYE	NAY	N.V.
GAJEWSKI	✓			YUN	✓			RIVERA	✓		
RAMCHAL	✓			OSBORNE	✓			WATTERMAN	✓		
BOGGIANO	✓			COLEMAN	✓			LAVARRO, PRES.	✓		

✓ Indicates Vote

N.V.-Not Voting (Abstain)

Adopted at a meeting of the Municipal Council of the City of Jersey City N.J.

Rolando R. Lavarro, Jr., President of Council

Robert Byrne, City Clerk

RESOLUTION FACT SHEET - CONTRACT AWARD

This summary sheet is to be attached to the front of any resolution that is submitted for Council consideration. Incomplete or vague fact sheets will be returned with the resolution.

Full Title of Ordinance/Resolution

RESOLUTION AUTHORIZING THE EXECUTION OF AN AGREEMENT BETWEEN THE JERSEY CITY EMPLOYMENT AND TRAINING PROGRAM AND THE CITY OF JERSEY CITY FOR THE LICENSING OF THE USE OF USED OFFICE FURNITURE.

Project Manager

Department/Division	Business Administrator	
Name/Title	Robert Kakoleski	Business Administrator
Phone/email	(201) 547-5147	RKakoleski@jenj.org

Note: Project Manager must be available by phone during agenda meeting (Wednesday prior to council meeting @ 4:00 p.m.)

Contract Purpose

For the execution of an agreement with the JCETP licensing the acceptance and use of furniture.

Jersey City Employment and Training Program ("JCETP") is moving to a refurbished property within the Martin Luther King HUB and is in need of office furniture so it can complete its nonprofit mission at the HUB.

The City is planning to convey personal property, attached as an Exhibit hereto ("the furniture"), that it no longer needs for municipal purposes to a nonprofit organization which include among its principal purposes the provision of educational or social services to the public.

Cost (Identify all sources and amounts)

No Fee

Contract term (include all proposed renewals)

Through September 30, 2014 or adoption of an ordinance by the City conveying title, whichever occurs sooner.

Type of award

If "Other Exception", enter type

Additional Information

See Contract Purpose

I certify that all the facts presented herein are accurate.

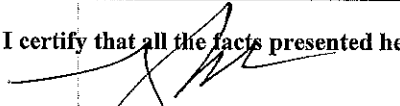

Signature of Department Director

9/7/14

Date

LICENSE AGREEMENT FOR DELIVERY AND USE OF FURNITURE

This AGREEMENT, entered into this ____ day of July, 2014, is made by and between the City of Jersey City (the "City"), a municipal corporation of the State of New Jersey with offices at City Hall, 280 Grove Street, Jersey City, New Jersey 07302, and the Jersey City Employment and Training Program (the "JCETP"), a non-profit corporation of the State of New Jersey with offices at 895 Bergen Avenue, Jersey City, NJ 07306.

WITNESSETH THAT:

WHEREAS, pursuant to City Resolution 14.110 adopted on February 26, 2014, the City accepted a gift of certain used office furniture from Mack-Cali Realty Corporation; and

WHEREAS, the JCETP is a duly incorporated quasi-public nonprofit organization, whose public purposes include the provision of educational and social services to those in need; and

WHEREAS, JCETP is moving to a refurbished property within the Martin Luther King HUB and is in need of office furniture so that it can complete its nonprofit mission at the HUB; and

WHEREAS, pursuant to N.J.S.A. 40A:12-21.1 and N.J.S.A. 40A:12-21(k), the City is planning to convey personal property, attached as Exhibit A (the "Furniture"), that it no longer needs for municipal purposes to a nonprofit organization which includes among its principal purposes the provision of educational or social services to the public; and

WHEREAS, the City finds it more cost effective to deliver the furniture to the refurbished property within the Martin Luther King HUB currently leased, and to be occupied by, the JCETP prior to conveying the furniture to the JCETP;

NOW, THEREFORE, in consideration of the mutual promises and other conditions, covenants, and obligations made and agreed to by and between the parties, it is hereby agreed as follows:

1. TERM

The City grants to JCETP a license to receive and use all the Furniture for a term commencing as of the date of execution of this Agreement and terminating upon the date of conveyance of ownership of the Furniture to JCETP by the City or on September 30, 2014, whichever occurs sooner.

2. LOCATION

JCETP may receive, use and maintain the Furniture in accordance with its provision of employment and training related services at its offices located at 360-398 Martin Luther King Drive, Jersey City, NJ 07305.

3. MAINTENANCE

- a. JCETP shall maintain the Furniture in proper condition.
- b. JCETP shall be responsible for the maintenance and upkeep of the Furniture and any damage to the Furniture is solely the responsibility of JCETP. Should JCETP fail to maintain the Furniture, this Agreement is revocable on notice by the City to JCETP of a violation of this section; however JCETP shall have 14 days to cure any problem if it notifies the City in writing within three (3) days of its intent to cure the violation.

4. REVOCATION

This Agreement is revocable by the City within 30 days upon sending written notice to JCETP. Upon revocation, the Furniture may be removed by the City.

5. INDEMNIFICATION

The JCETP hereby covenants and agrees that it will defend, indemnify and save harmless the City, its officers, agents, and employees against any and all claims and any and all liability for damages, cost, charges and expenses of whatsoever kind or nature, including personal injury and property damage arising out of JECTP's receiving and use of the Furniture under this Agreement, other than liability arising out of the sole negligence or intentional or wanton or willful acts of the City. This section shall survive the termination of this Agreement.

6. CONDITION OF PROPERTY

As a material part of the consideration for this Agreement, the City and JCETP agree that JCETP is taking the Furniture "AS IS" with any and all latent and patent defects and that there is no warranty by the City that the Furniture is fit for a particular purpose. JCETP acknowledges that it is not relying upon any representation, statement or other assertion with respect to the Furniture condition, but is relying upon its examination of the Furniture. JCETP takes the Furniture under the express understanding that there are no express or implied warranties. This section shall survive the termination of this Agreement.

7. ASSIGNMENT OF RIGHTS

JCETP shall not sell or assign its rights pursuant to this Agreement or permit the use of the Furniture or any part thereof by any other entity without the express prior written consent of the City. Any unauthorized action in violation of this provision shall be void, and shall terminate JCETP'S rights pursuant to this Agreement.

8. LIMITATION OF RIGHTS

JCETP acknowledges that no property or other right is created other than that specifically defined and limited by this Agreement.

IN WITNESS WHEREOF, the parties have caused this Agreement to be duly signed and sealed the day and year first above written.

CITY OF JERSEY CITY

JERSEY CITY EMPLOYMENT TRAINING PROGRAM

By:

By:

EXHIBIT A

JCETP HUB Furniture Inventory as of 6/24/14

#	Furniture Description	Marking (V)	Floor	Section	Notes	Furniture Measurement	# of Sections
1	CREENZA	x	7	A	WAITING ROOM AREA		
1	WAITING ROOM CHAIR	X	7	A	WAITING ROOM AREA		
1	BOOK CASE	X	7	B	RECEPTION AREA	4FT 4IN L X 3FT 2IN W	
1	BOOK CASE	X	7	B	OFFICETBD #2	4FT 4IN L X 3FT 2IN W	
3	BOOK CASE	X	7	C	FISCAL	4FT 4IN L X 3FT 2IN W	(2) 7C SECTIONS
2	CANVAS DESK BOARD		7	C	FISCAL		(2) 7C SECTIONS
1	CANVAS DESK BOARD		7	C			(2) 7C SECTIONS
2	OVERHEAD BINS	x	7	C	FISCAL	6FT L X 1FT 2 IN W	(2) 7C SECTIONS
2	STANDARD DESK	X	7	C	FISCAL	6FT 1 IN L X 3FT 1 IN W	(2) 7C SECTIONS
1	BOOK CASE	X	7	D	OFFICE 1	4FT 4IN L X 3FT 2IN W	(3) 7D SECTIONS
1	BOOK CASE	X	7	D	OFFICETBD #3	4FT 4IN L X 3FT 2IN W	(3) 7D SECTIONS
1	CANVAS DESK BOARD		7	D	RECEPTION AREA		(3) 7D SECTIONS
1	CANVAS DESK BOARD		7	D	OFFICE 1		(3) 7D SECTIONS
1	CANVAS DESK BOARD		7	D	OFFICETBD #3		(3) 7D SECTIONS
1	CANVAS DESK BOARD		7	D	OFFICE 2		(3) 7D SECTIONS
1	CONFERENCE CHAIR	X	7	D	CONFERENCE ROOM		(3) 7D SECTIONS
1	HIGH BACK DESK CHAIR	X	7	D	OFFICETBD #3		(3) 7D SECTIONS
1	HIGH BACK DESK CHAIR	X	7	D	JCETP STAFF		(3) 7D SECTIONS
1	L-SHAPE DESK	X	7	D	RECEPTION AREA	6FT 5 IN L X 5FT 6IN W	(3) 7D SECTIONS
1	L-SHAPE DESK	X	7	D	FISCAL - NURIA	6FT 5 IN L X 5FT 6IN W	(3) 7D SECTIONS
1	OVERHEAD BINS	X	7	D	RECEPTION AREA	6FT L X 1FT 2 IN W	(3) 7D SECTIONS
1	OVERHEAD BINS	X	7	D	OFFICE 1	6FT L X 1FT 2 IN W	(3) 7D SECTIONS
1	OVERHEAD BINS	X	7	D	OFFICETBD #3	6FT L X 1FT 2 IN W	(3) 7D SECTIONS
1	OVERHEAD BINS	X	7	D	OFFICE 2	6FT L X 1FT 2 IN W	(3) 7D SECTIONS
1	STANDARD DESK	X	7	D	OFFICE 1	6FT 1 IN L X 3FT 1 IN W	(3) 7D SECTIONS
1	STANDARD DESK	X	7	D	OFFICETBD #3	6FT 1 IN L X 3FT 1 IN W	(3) 7D SECTIONS
1	STANDARD DESK	X	7	D	OFFICE 2	6FT 1 IN L X 3FT 1 IN W	(3) 7D SECTIONS
1	TYPEWRITER TABLE		7	D	FISCAL		(3) 7D SECTIONS
1	UTILITY CHAIR		7	D			(3) 7D SECTIONS
18	WAITING ROOM CHAIR	X	7	D	WAITING ROOM AREA		(3) 7D SECTIONS
6	8 FT TALL CABINETS	X	7	E	CLASSROOM #1		
1	BOOK CASE	X	7	F	OFFICE 3	4FT 4IN L X 3FT 2IN W	
1	CANVAS DESK BOARD		7	F	OFFICE 3		
1	L-SHAPE DESK	X	7	F	FISCAL	6FT 5 IN L X 5FT 6IN W	
1	OVERHEAD BINS	X	7	F	OFFICE 3	6FT L X 1FT 2 IN W	
1	BOOK CASE	X	7	G	OFFICE 4	4FT 4IN L X 3FT 2IN W	
1	BOOK CASE	X	7	G	OFFICE 2	4FT 4IN L X 3FT 2IN W	
1	CANVAS DESK BOARD	X	7	G	OFFICE 4		
1	OVERHEAD BINS	X	7	G	OFFICE 4	6FT L X 1FT 2 IN W	
1	STANDARD DESK	X	7	G	OFFICE 4	6FT 1 IN L X 3FT 1 IN W	
1	BOOK CASE	X	7	H	OFFICE 5	4FT 4IN L X 3FT 2IN W	(3) 7H SECTIONS
1	BOOK CASE	X	7	H	OFFICE 6	4FT 4IN L X 3FT 2IN W	(3) 7H SECTIONS
1	OVERHEAD BINS	X	7	H	OFFICE 6	6FT L X 1FT 2 IN W	(3) 7H SECTIONS
1	OVERHEAD BINS	X	7	H	OFFICE 5	6FT L X 1FT 2 IN W	(3) 7H SECTIONS
1	STANDARD DESK	X	7	H	OFFICE 6	6FT 1 IN L X 3FT 1 IN W	(3) 7H SECTIONS
14	WAITING ROOM CHAIR		7	H	WAITING ROOM AREA		(3) 7H SECTIONS

1	WHITE BOARD	X	7	I	CLASSROOM #1		
6	BURGUNDY DESK ROLLING CHAIR	X	7	J	REENTRY / COMPLIANCE		
3	DESK CHAIRS						
1	LONG DESK 6 FT X 1.9 FT	X	3	C	TO BE DETERMINED		
14	BLACK ROLLING COMPUTER CHAIRS	X	3	O	COMPUTER ROOM		
3	HIGH BACK DESK CHAIR	X	3	O	OFFICES - RE-ENTRY		
5	BURGUNDY VISITOR CHAIR	X	7	J			
10	CONFERENCE CHAIR		7	J	CONFERENCE ROOM		
7	HIGH BACK DESK CHAIR		7	J	JCETP STAFF		
1	MEDIA BOARD WITH WOOD DOOR	X	7	J	CLASSROOM #1		
10	WAITING ROOM CHAIR		7	J	WAITING ROOM AREA		
1	WHITE BOARD		7	J	CLASSROOM		
1	CREDENZA		7	K	CONFERENCE ROOM	6FT 7IN L X 1FT 9IN W	
1	MEDIA BOARD WITH WOOD DOOR		7	K	CONFERENCE ROOM		
2	8 FT TALL CABINETS	X	7	L	CLASSROOM		
12	BLUE LAB CHAIR		7	M	CLASSROOM LAB		
6	LAB TABLE		7	M	CLASSROOM LAB		
1	LAB TABLE		7	M	IT OFFICE		
1	UTILITY ROLLING CHAIR		7	M	IT OFFICE		
3	BURGUNDY DESK ROLLING CHAIR		3	A	REENTRY / COMPLIANCE		(3) 3 A SECTIONS
5	BURGUNDY VISITOR CHAIR		3	A	REENTRY / COMPLIANCE		(3) 3 A SECTIONS
8	CUBICLES 6 X 6		3	A	SMALL CUBICLES		(3) 3 A SECTIONS
1	GREY GARBAGE BIN		3	A			(3) 3 A SECTIONS
1	REFRIGERATOR		3	O	KITCHEN		
1	PODIUM		3	A			(3) 3 A SECTIONS
27	RECYCLE BIN		3	A			(3) 3 A SECTIONS
1	ROLLING CART SMALL		3	A			(3) 3 A SECTIONS
1	SMALL ROUND TABLE		3	A	CONVERSATION SESSIONS	1FT 8IN L X 1FT 10 IN W	(3) 3 A SECTIONS
1	SMALL SQUARE SIDE TABLE		3	A		1FT 6IN L X 2FT 2 IN W	(3) 3 A SECTIONS
1	TAPERED DESK	X	3	B	CLASSROOM	6FT LX 1FT 8IN W	
1	STANDARD DESK	X	3	C	PROVIDER	5FT 6IN L X 5FT 7IN W	(2) 3C SECTIONS
1	STANDARD DESK	X	3	C	PROVIDER	5FT 6IN L X 5FT 7IN W	(2) 3C SECTIONS
8	CUBICLES 12X6 CHERRY WOOD TOP		3	D			

Resolution of the City of Jersey City, N.J.

City Clerk File No. Res. 14.484
 Agenda No. 10.Q
 Approved: JUL 16 2014

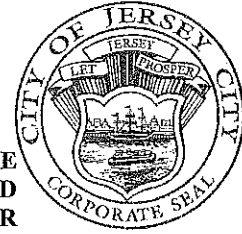

TITLE: RESOLUTION EXTENDING THE TERM OF THE LICENSE AGREEMENT BETWEEN THE CITY OF JERSEY CITY AND GREYSTONE ENVIRONMENTAL MANAGEMENT, LLC TO ENTER ONTO CITY PROPERTY DESIGNATED AS BLOCK 15801 LOT 3 A/K/A 52 AETNA STREET AND BLOCK 15801, LOT 78 A/K/A 41 AETNA STREET FOR AN ADDITIONAL 5 MONTHS

COUNCIL offered and moved adoption of the following resolution:

WHEREAS, the City is the owner of property designated as Block 15801, Lot 3 a/k/a 52 Aetna Street and Block 15801, Lot 78 a/k/a 41 Aetna Street; and

WHEREAS, Greystone Environmental Management, LLC ("Greystone") needed to enter onto the property to transport field sampling equipment, a support vehicle, and personnel around the Metallix building and to conduct a remedial investigation on Metallix properties for a period of five (5) months; and

WHEREAS, by the adoption of a Resolution on March 26, 2014, the City authorized the execution of a license agreement with Greystone; and

WHEREAS, the license agreement will expire on August 1, 2014; and

WHEREAS, Greystone advises that it will require an additional 5 months to complete its work since it is required to demolish a building on Metallix's property before Greystone can proceed with its remedial investigation; and

WHEREAS, the City of Jersey agrees to extend the term of the license agreement with Greystone for 5 months; and

WHEREAS, Greystone will submit copies of all reports and data connected to its investigation and remediation to the City as soon as practicable insofar as the reports or data impact conditions on the City's property.

NOW, THEREFORE, BE IT RESOLVED, by the Municipal Council of the City of Jersey City that:

1. The Business Administrator is authorized to execute an extension (and amendment appropriate) of the license agreement between the City of Jersey City and Greystone Environmental Management, LLC with a new expiration date of January 1, 2015.

APPROVED: _____

APPROVED AS TO LEGAL FORM

APPROVED: _____

Business Administrator

 Corporation Counsel

Certification Required

Not Required

APPROVED 9-0

RECORD OF COUNCIL VOTE ON FINAL PASSAGE 7.16.14											
COUNCILPERSON	AYE	NAY	N.V.	COUNCILPERSON	AYE	NAY	N.V.	COUNCILPERSON	AYE	NAY	N.V.
GAJEWSKI	✓			YUN	✓			RIVERA			
RAMCHAL	✓			OSBORNE	✓			WATTERMAN			
BOGGIANO	✓			COLEMAN	✓			LAVARRO, PRES.			

✓ Indicates Vote

N.V.-Not Voting (Abstain)

Adopted at a meeting of the Municipal Council of the City of Jersey City N.J.

 Rolando R. Lavarro, Jr., President of Council

 Robert Byrne, City Clerk

RESOLUTION FACT SHEET – NON-CONTRACTUAL

This summary sheet is to be attached to the front of any resolution that is submitted for Council consideration. Incomplete or vague fact sheets will be returned with the resolution.

Full Title of Ordinance/Resolution

RESOLUTION EXTENDING THE TERM OF THE LICENSE AGREEMENT BETWEEN THE CITY OF JERSEY CITY AND GREYSTONE ENVIRONMENTAL MANAGEMENT, LLC TO ENTER ONTO CITY PROPERTY DESIGNATED AS BLOCK 15801 LOT 3 A/K/A 52 AETNA STREET AND BLOCK 15801, LOT 78 A/K/A 41 AETNA STREET

Initiator

Department/Division	Administration	Real Estate
Name/Title	Steve Miller	Confidential Assistant
Phone/email	(201) 547-4904	Steven@jcnj.org

Note: Initiator must be available by phone during agenda meeting (Wednesday prior to council meeting @ 4:00 p.m.)

Resolution Purpose

Greystone was granted permission to enter onto City owned property designated as Block 15801, Lot 3 a/k/a 52 Aetna Street and Block 15801, Lot 78 a/k/a 41 Aetna Street to transport field sampling equipment, a support vehicle, and personnel around the Metallix building to conduct a remedial investigation on Metallix properties for a period of five (5) months, ending on August 1, 2014.

Presently, we are seeking a Resolution extending the term of the license agreement between the City of Jersey City and Greystone Environmental Management, LLC to enter onto City property designated as block 15801 Lot 3 a/k/a 52 Aetna Street and Block 58901, Lot 78 a/k/a 41 Aetna Street for an additional 5 months – August 1, 2014 to January 1, 2015.

I certify that all the facts presented herein are accurate.

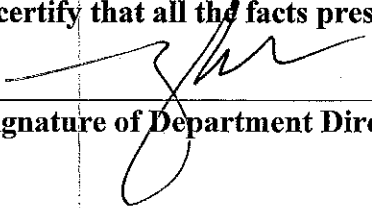

Signature of Department Director

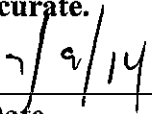

Date

Resolution of the City of Jersey City, N.J.

City Clerk File No. Res. 14.485

Agenda No. 10.R

Approved: JUL 16 2014



TITLE: **AMENDING RESOLUTION TO 14.332;
AN AGREEMENT WITH BROADVIEW NETWORKS, INC.**

COUNCIL OFFERED AND MOVED ADOPTION OF THE FOLLOWING RESOLUTION:

WHEREAS, the City sought to award a contract to **BROADVIEW NETWORKS, INC** for a three year term, and the original resolution (14.332) did not specify that term, this resolution is being submitted to codify the three year term.

NOW THEREFORE BE IT RESOLVED by the Municipal Council of the City of Jersey City that :

1. The Mayor and/or Business Administrator be authorized to sign the contract with **BROADVIEW NETWORKS, INC** for a term of three years.
2. A copy of this resolution shall be printed in a newspaper of general circulation within the City of Jersey City, within ten (10) days of passage of this resolution.

I, Donna Mauer (Donna Mauer), as Chief Financial Officer, hereby certify that these funds are available for this expenditure in Account Number: **01-201-31-435-620** for payment of the above Resolution.

Administration Department
Account No. : **01-201-31-435-620** P.O. # **113428** Amt. **\$17,000.00**

APPROVED: [Signature] APPROVED AS TO LEGAL FORM

APPROVED: [Signature] [Signature]
Business Administrator Corporation Counsel

Certification Required

Not Required

APPROVED 9-0

RECORD OF COUNCIL VOTE ON FINAL PASSAGE 7.16.14											
COUNCILPERSON	AYE	NAY	N.V.	COUNCILPERSON	AYE	NAY	N.V.	COUNCILPERSON	AYE	NAY	N.V.
GAJEWSKI	✓			YUN	✓			LAVARRO	✓		
KHEMRAJ	✓			OSBORNE	✓			WATTERMAN	✓		
BOGGIANO	✓			COLEMAN	✓			RIVERA	✓		

✓ Indicates Vote

N.V.-Not Voting (Abstain)

Adopted at a meeting of the Municipal Council of the City of Jersey City N.J.

[Signature]
Rolando Lavarro, President of Council

[Signature]
Robert Byrne, City Clerk

RESOLUTION FACT SHEET, NON-CONTRACTUAL

This summary sheet is to be attached to the front of any resolution that is submitted for Council consideration. Incomplete or vague fact sheets will be returned with the resolution.

Full Title of Ordinance/Resolution

**AMENDING RESOLUTION TO 14.332;
AN AGREEMENT WITH BROADVIEW NETWORKS, INC.**

Initiator

Department/Division	ADMINISTRATION	INFORMATION TECHNOLOGY
Name/Title	ROBERT MAGRO	IT DIRECTOR
Phone/email	201-547-4274	bobm@jenj.org

Note: Initiator must be available by phone during agenda meeting (Wednesday prior to council meeting @ 4:00 p.m.)

Resolution Purpose

The City is entering into a 3-year contract with Broadview Networks for Plain Old Telephone Line (POTS) service. The original resolution did not mention the contract was for a 3-year term. A 3-year contract enables the City to realize a larger price discount for the services.

I certify that all the facts presented herein are accurate.

Signature of Department Director

6-16-14
Date

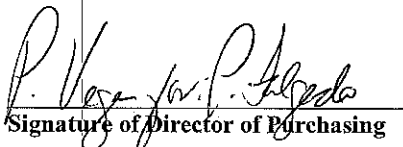
Signature of Director of Purchasing

6.17.14
Date

Resolution of the City of Jersey City, N.J.

City Clerk File No. Res. 14.332
Agenda No. 10.Z.14
Approved: MAY 14 2014



TITLE:

RESOLUTION AUTHORIZING THE AWARD OF CONTRACT TO BROADVIEW NETWORKS, INC. TO PROVIDE VOICE TELEPHONE SERVICES UNDER STATE CONTRACT FOR THE DEPARTMENT OF ADMINISTRATION/INFORMATION TECHNOLOGY

COUNCIL OFFERED AND MOVED ADOPTION OF THE FOLLOWING RESOLUTION:

WHEREAS, funding is required for Broadview Networks, Inc. to provide POTS (Plain Old Telephone Service) telephone services during Calendar Year 2014; and

WHEREAS, N.J.S.A. 40A:11-12, of the Local Public Contracts Law authorizes municipalities to use a State Contract and N.J.A.C. 5:34-7.29 requires City Council authorization for contracts exceeding \$36,000.00; and

WHEREAS, Broadview Networks Inc. P.O. Box 9242, Uniondale, New York 11555 being in possession of State Contract A85017, will provide Voice Telephone Services in the total annual amount of Ninety Six Thousand Dollars (\$96,000.00); and

WHEREAS, funds in the amount of \$17,000 are available in the calendar year 2014 temporary budget for this expenditure in accordance with requirements of the Local Budget Law, N.J.S.A. 40A:4-1 et seq. in account No. 01-201-31-435-620; and

WHEREAS, these funds are available for this expenditure in the account shown below

Department of Administration/Information Technology			
Acct No.	P.O #	State Contract	Temp
			Encumbrance
01-201-31-435-620	113428	A85017	\$17,000.00

WHEREAS, the award of contract shall be subject to the availability and appropriation of sufficient funds in the 2014 temporary and permanent budget;

WHEREAS, the City's Director of Purchasing has certified that he considers the amount to be fair and reasonable; and

NOW, THEREFORE, BE IT RESOLVED, by the Municipal Council of the City of Jersey City that the said bid of the aforementioned **Broadview Networks Inc.**, be accepted and that a contract be awarded to said company in the above amount, and the Director of Purchasing is directed to have such a contract drawn up and executed; and be it further

RESOLVED, that upon certification by an official or employee of the City authorized to receive the material pursuant to the contract, that the same has been received and that the requirements of the contract met, then; payment to the contractor shall be made in accordance with the provisions of the Local Fiscal Affairs Law, N.J.S.A. 40A:5-1 et. seq. and be it further

RESOLVED, pursuant to N.J.A.C. 5:34-5.3(a), the continuation of the contract after the expenditure of funds encumbered in the 2014 fiscal year temporary budget shall be subject to the availability and appropriation of sufficient funds in the 2014 fiscal year permanent budget; and be it further

(Continued on page 2)

City Clerk File No. Res. 14-332

Agenda No. 10.7.14

TITLE: MAY 14 2014

RESOLUTION AUTHORIZING THE AWARD OF CONTRACT TO BROADVIEW NETWORKS, INC. TO PROVIDE VOICE TELEPHONE SERVICES UNDER STATE CONTRACT FOR THE DEPARTMENT OF ADMINISTRATION/INFORMATION TECHNOLOGY

RESOLVED, that the Mayor or Business Administrator is hereby authorized to execute a contract on behalf of the City of Jersey City.

I, Donna Mauer, Donna Mauer, Chief Financial Officer, certify that there are sufficient funds available for payment of this above resolution.

Department of Administration/Information Technology			
Acct No.	P.O #	State Contract	Temp Encumbrance
01-201-31-435-620	113428	A85017	\$17,000.00

Approved by Patricia M Vega for P. Folgado Date April 24, 2014
 Patricia M Vega, Principal Buyer, RPPS for: Date
 Peter Folgado, Director of Purchasing, RPPO, QPA

DV
4/24/14

APPROVED: _____

APPROVED AS TO LEGAL FORM _____

APPROVED: _____

Business Administrator

Corporation Counsel

Certification Required

Not Required

APPROVED 9-0

RECORD OF COUNCIL VOTE ON FINAL PASSAGE 5.14.14											
COUNCILPERSON	AYE	NAY	N.V.	COUNCILPERSON	AYE	NAY	N.V.	COUNCILPERSON	AYE	NAY	N.V.
GAJEWSKI	✓			YUN	✓			RIVERA	✓		
RAMCHAL	✓			OSBORNE	✓			WATTERMANN	✓		
BOGGIANO	✓			COLEMAN	✓			LAVARRO, PRES.	✓		

✓ Indicates Vote

N.V.-Not Voting (Abstain)

Adopted at a meeting of the Municipal Council of the City of Jersey City N.J.

Rolando R. Lavarro, Jr., President of Council

Robert Byrne, City Clerk

Resolution of the City of Jersey City, N.J.

City Clerk File No. Res. 14.486

Agenda No. 10.5

Approved: JUL 16 2014

TITLE:



**RESOLUTION OF THE MUNICIPAL COUNCIL OF THE CITY OF JERSEY CITY
AWARDING A PROFESSIONAL SERVICES CONTRACT TO PAUL STEFFENS OF
PRS CONSULTANTS, INC. TO PROVIDE COORDINATING SERVICES FOR THE
CITY OF JERSEY CITY DEPARTMENT OF HEALTH AND HUMAN SERVICES
MUNICIPAL DRUG ALLIANCE PROGRAM**

**COUNCIL AS A WHOLE, OFFERED AND MOVED ADOPTION OF THE
FOLLOWING RESOLUTION:**

WHEREAS, the City of Jersey City (City), Department of Health and Human Services (Department) requires the services of an Alliance Coordinator for its Municipal Drug Alliance Program to coordinate and oversee the operations of the program and its sub-grantees; and

WHEREAS, the County of Hudson (County) awarded a grant to the City to be used to fund the operations of the City's Municipal Drug Alliance Program; and

WHEREAS, as a condition of the grant award the City is required to contract with Paul Steffens of PRS Consultants, Inc. a Licensed Clinical Alcohol and Drug Counselor (Consultant), to provide services as the Alliance Coordinator for the Municipal Drug Alliance Program; and

WHEREAS, these services qualify as professional services exempt from public bidding under the Local Public Contracts Law, N.J.S.A. 40A:11-1 et seq.; and

WHEREAS, the total amount of this contract is Sixty Thousand (\$60,000.00) dollars for a period of twelve months, effective July 1, 2014 through June 30, 2015; and

WHEREAS, the funds in the amount of Sixty Thousand (\$60,000.00) dollars are available in the Municipal Drug Alliance Program Fund Account No. 02-213-40-460-312; and

WHEREAS, the City is acquiring these services directly and openly as a statutorily permitted contract pursuant to the provisions of N.J.S.A. 19:44A-20.5 et seq. (Pay-To-Play Law); and

WHEREAS, the Department Director has determined and certified in writing that the value of the contract exceeds \$17,500; and

WHEREAS, the Consultant has completed and submitted a Business Entity Disclosure Certification which certifies that the Consultant has not made any reportable contributions to a political or candidate committee listed on the Business Entity Disclosure Certification in the previous one year, and that the contract will prohibit PRS Consultants, Inc. from making any reportable contributions during the term of the contract; and

WHEREAS, the Consultant has submitted a Chapter 271 Political Contribution Disclosure Certification at least 10 days prior to the award of this contract; and

WHEREAS, the Consultant has submitted his Certification of Compliance with the City's Contractor Pay-to-Play Reform Ordinance 08-128 adopted on September 3, 2008; and

WHEREAS, the resolution authorizing the award and the agreement itself must be available for public inspection

TITLE:

RESOLUTION OF THE MUNICIPAL COUNCIL OF THE CITY OF JERSEY CITY AWARDING A PROFESSIONAL SERVICES CONTRACT TO PAUL STEFFENS OF PRS CONSULTANTS, INC. TO PROVIDE COORDINATING SERVICES FOR THE CITY OF JERSEY CITY DEPARTMENT OF HEALTH AND HUMAN SERVICES MUNICIPAL DRUG ALLIANCE PROGRAM

NOW, THEREFORE, BE IT RESOLVED, by the Municipal Council of the City of Jersey City that:

1. Subject to such modifications as may be deemed necessary appropriate by Corporation Counsel, the Mayor or Business Administrator is authorized to execute the attached agreement with Paul Steffens, LCADC of PRS Consultants, Inc. to provide services as the Alliance Coordinator for the Municipal Drug Alliance Program;
2. The total amount of the contract shall not exceed Sixty Thousand (\$60,000.00) dollars and the term of the contract shall be for twelve months effective July 1, 2014 thru June 30, 2015;
3. This agreement is awarded without competitive bidding as a professional services agreement under the Public Contracts Law, N.J.S.A. 40A:11-1 et seq.;
4. A copy of this resolution will be published in a newspaper of general circulation in the City of Jersey City as required by law with ten (10) days of the adoption of this resolution;
5. The award of this contract shall be subject to the condition that the contractor provide satisfactory evidence of compliance with Affirmative Action Amendments to the Law Against Discrimination, N.J.S.A. 10:5-31 et seq.;
6. Upon certification by an official or employee of the City authorized to attest that the contractor complied with the specifications in all respects, and requirements of the contract met, then payment to the contractor shall be made in accordance with the provisions of the Local Fiscal Affairs Law, N.J.S.A. 40A:5-1 et seq.; and
7. The Business Entity Disclosure Certification, Chapter 271 Political Contribution Disclosure Certification, Certification of Compliance with the City's Contractor Pay-to-Play reform Ordinance, and Determination of value Certification attached hereto and incorporated herein by reference shall be placed on file with this resolution.

I, Donna Mauer Donna Mauer, Chief Financial Officer, hereby, certify that funds in the amount of \$60,000.00 are available in the Municipal Drug Alliance Program Fund Account No. 02-213-40-460-312 for the payment of this resolution. PO # 114099

APPROVED: [Signature] APPROVED AS TO LEGAL FORM

APPROVED: [Signature] Business Administrator ASST. Corporation Counsel

Certification Required

Not Required

APPROVED 9-0

RECORD OF COUNCIL VOTE ON FINAL PASSAGE 7.16.14											
COUNCILPERSON	AYE	NAY	N.V.	COUNCILPERSON	AYE	NAY	N.V.	COUNCILPERSON	AYE	NAY	N.V.
GAJEWSKI	✓			YUN	✓			RIVERA	✓		
RAMCHAL	✓			OSBORNE	✓			WATTERMAN	✓		
BOGGIANO	✓			COLEMAN	✓			LAVARRO, PRES.	✓		

✓ Indicates Vote

N.V.-Not Voting (Abstain)

Adopted at a meeting of the Municipal Council of the City of Jersey City N.J.

[Signature]
Rolando R. Lavarro, Jr., President of Council

[Signature]
Robert Byrne, City Clerk

RESOLUTION FACT SHEET - CONTRACT AWARD

This summary sheet is to be attached to the front of any resolution that is submitted for Council consideration. Incomplete or vague fact sheets will be returned with the resolution.

Full Title of Ordinance/Resolution

RESOLUTION OF THE MUNICIPAL COUNCIL OF THE CITY OF JERSEY CITY AWARDING A PROFESSIONAL SERVICES CONTRACT TO PAUL STEFFENS OF PRS CONSULTANTS, INC. TO PROVIDE COORDINATING SERVICES FOR THE CITY OF JERSEY CITY DEPARTMENT OF HEALTH AND HUMAN SERVICES MUNICIPAL DRUG ALLIANCE PROGRAM

Project Manager

Department/Division	Health & Human Services	Director's Office
Name/Title	Stacey Flanagan	Director of DHHS
Phone/email	201-547-6560	sflanagan@jcnj.org

Note: Project Manager must be available by phone during agenda meeting (Wednesday prior to council meeting @ 4:00 p.m.)

Contract Purpose

Program Coordinating Services as a Licensed Clinical Alcohol and Drug Counselor, as required condition of the grant award to the City of Jersey City.

Cost (Identify all sources and amounts)

Hudson County Grant- \$60,000
Cash Match- \$53,476
In-Kind - \$34,427

Contract term (include all proposed renewals)

July 1, 2014 – June 30, 2015

Type of award Professional Services

If "Other Exception", enter type

Additional Information

I certify that all the facts presented herein are accurate.

Signature of Department Director

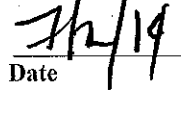
Date

DETERMINATION OF VALUE CERTIFICATION

Stacey Flanagan, of full age, hereby certifies as follows:

1. I am the Director of the City of Jersey City (City) Department of Health and Human Services (DHHS) and have knowledge of the goods and services provided by the DHHS.
2. PRS Consultants, Inc promotes drug-free and non-violent values, attitudes and interpersonal skills through their substance abuse prevention and education programs.
3. The City informally solicited quotations for services as professional services pursuant to N.J.S.A. 40A:11-5(1)(a)(i).
4. PRS Consultants, Inc submitted a proposal to provide a masters-level clinician, licensed by the New Jersey Department of Community Affairs – State Board of Marriage and Family Therapy Examiners as a Clinical Alcohol and Drug Counselor (LCADC) with (30) years of experience in the field of substance abuse prevention, education and treatment to assume the role of Municipal Alliance Coordinator for the sum of \$60,000.00.
5. The DHHS recommendation is to award the contract to PRS Consultants, Inc.
6. The term of the contract is July 1, 2014 through June 30, 2015.
7. The estimated amount of the contract exceeds \$17,500.00.
8. This certification is made pursuant to N.J.S.A. 19:44A-20.5.
9. I certify that the foregoing statements are true. I am aware that if any of the foregoing statements made by me are willfully false, I am subject to punishment.

Date: _____

7/2/14



Stacey Flanagan, Director

Department of Health and Human Services

AGREEMENT

THIS AGREEMENT entered into this _____ day of _____, 2014, by and between the City of Jersey City, a Municipal Corporation, organized and existing under the laws of the State of New Jersey, with its principal place of business 280 Grove Street, in the City of Jersey City, the County of Hudson, and the State of New Jersey (herein referred to as the "City") and **Paul Steffens of PRS Consultants, Inc.**, a Licensed Clinical Alcohol and Drug Counselor, **License Number 37LC00128100**, with its principal place of business 6 Tuscany Circle, Manchester, NJ 08759, (herein referred to as the "Consultant").

WITNESSETH THAT:

WHEREAS, the City is a Municipal Corporation that conducts the Municipal Drug Alliance Program under the auspices of the Department of Health and Human Services at 199-201 Summit Avenue, Jersey City, NJ 07304. The City desires to have the following services performed by the Consultant; and

WHEREAS, the Consultant agrees to perform these services for the City under the terms and conditions set forth in this contract; and

WHEREAS, the Consultant is duly licensed to practice his profession as a Licensed Clinical Alcohol and Drug Counselor (LCADC) in the State of New Jersey with thirty years' experience in the field of addiction; and

WHEREAS, this Agreement shall be in effect for twelve (12) months effective **July 1, 2014 to June 30, 2015**, and the total amount of the contract shall not exceed **Sixty Thousand (\$60,000.00)** Dollars.

NOW, THEREFORE, in consideration of the mutual promises and covenants set forth herein, the parties agree as follows:

1. Nature of Work

The Consultant shall in satisfactory manner as determined by the City perform those services outlined in Attachment A.

2. Compliance with Approved Program

All activities authorized by this Agreement will be performed, as delineated in Attachment A, in accordance with the approved work program, the approved budget, the grant conditions and special conditions as required by the City.

3. Compensation

For all services rendered, under the terms of this agreement the total contract amount shall not exceed **Sixty Thousand (\$60,000.00) Dollars**. The Consultant shall bill the City for services rendered on a monthly basis in a timely manner, provided all requirements of the Agreement are satisfactorily met.

4. Relationship of Parties

The parties agree that the Consultant and the relation created by this contract is that of employer and independent contractor. The Consultant is not an employee of the City, is not entitled to the benefits provided by the employer to its employees, including but not limited to group insurance, pension plan and workmen's compensation benefits. Consultant may practice his/her service for others during those periods when the Consultant is not performing work under the contract for the City.

5. Errors and Omissions

Consultant shall perform its services consistent with the professional skill and care ordinarily required by program specifications as practiced by Municipal Alliances of the same or similar locality under the same or similar circumstances. Consultant shall perform its services as expeditiously as is consistent with such professional skill and care to ensure compliance and the orderly progress of the project. Consultant must also provide proof of Errors and Omissions/Professional Liability in the amount of \$1,000,000.

6. Termination

Either party shall have the right to terminate this Agreement in whole or in part without cause at any time upon 30 days' written notice. Upon receipt of termination notice, the Consultant shall immediately discontinue services. The Consultant shall be paid the amount earned by or reimbursable to the Consultant hereunder to the time specified in said notice. The Consultant shall have no further claim against the City with respect thereto.

7. Entire Agreement

This Agreement constitutes the entire agreement between City and the Consultant. It supersedes all prior or contemporaneous communications, representations of agreement, whether oral or written with respect to the subject matter thereof and has been induced by no representations, statements or agreements other than those herein expressed. No agreement hereafter made between the parties shall be binding on either party unless reduced to writing and signed by an authorized officer of the party sought to be bound thereby.

8. Assignment

The Consultant shall make no assignment or transfer of this Agreement or assign or transfer any part of the work under this Agreement.

9. Choice of Law

This Agreement shall be deemed to have been made, executed and delivered in the State of New Jersey. The terms and conditions of this Agreement shall be constructed in accordance with the laws of the State of New Jersey.

10. Modification

The parties hereto reserve the right subject to mutual assent, to modify the terms and conditions as herein contained, as necessary and as evidenced by a written formal executed Addendum to the Agreement.

11. Counter-Parts

This Agreement shall be executed in four counter-parts, each of which shall be deemed to be an original and such counter-parts shall constitute one and the same document.

12. Paragraph Headings

The paragraph headings in this Agreement are for convenience only; they form no part of this Agreement and shall not affect its interpretation.

13. Severability

If any provision of this Agreement shall be held to be invalid, illegal or unenforceable, such determination shall not affect or impair any other provision of this Agreement.

14. Indulgences

Neither the failure nor any delay on the part of any party hereto to exercise any right, remedy, power or privilege (collectively "rights") under this Agreement shall operate as a waiver thereof, nor shall any single or partial exercise of any right preclude any other or further exercise of the same or any other right, or, with respect to any occurrence be construed as a waiver of such right with respect to any other occurrence.

15. Notice

All notices, requests, demands or other communications hereunder shall be in writing and shall be deemed to be duly given if delivered to:

**Business Administrator
City Hall, 280 Grove St.
Jersey City, N.J. 07302**

**PRS Consultants, Inc.
6 Tuscany Circle,
Manchester, NJ 08759**

16. Records and Files

All records and files shall belong to and remain the property of the City. The Consultant shall not be entitled to keep or reproduce City's records or files related to any sub-grantee or participant or subject of the Municipal Drug Alliance Program unless the sub-grantee or participant requests specifically that his/her records be transmitted to the Consultant.

17. Miscellaneous

This Agreement shall be interpreted and governed according to the laws of the State of New Jersey.

18. New Jersey Business Registration Requirements

The Consultant shall provide written notice to its subcontractors of the responsibility to submit proof of business registration to the Consultant.

Before final payment on the contract is made by the contracting agency, the Consultant shall submit an accurate list and the proof of business registration of each subcontractor or supplier used in the fulfillment of the contract, or shall attest that no subcontractors were used.

For the term of the contract, the Consultant and each of its affiliates and a subcontractor and each of its affiliates (N.J.S.A. 52:32-44(g)(3) shall collect and remit to the Director, New Jersey Division of Taxation, the use tax due pursuant to the Sales and User Tax Act on all sales of tangible personal property delivered into this State, regardless of whether the tangible personal property is intended for a contract with a contracting agency.

A business organization that fails to provide a copy of a business registration as required pursuant to section 1 of P.L. 2001, c.134 (C.52:32-44 et seq.) Or subsection (e.) or (f.) of section 92 of P.L. 1977, c.110 (C.5:12-92), or that provides false business registration information under the requirements of either of those sections, shall be liable for a penalty of

\$25 for each day of violation, not to exceed \$50,000 for each business registration copy not properly provided under a contract with a contracting agency.

19. City of Jersey City Contractor Pay-To-Play Reform Ordinance

This contract was awarded in accordance with the City of Jersey City's Contractor Pay-to-Play Reform Ordinance, Section 3-51.1 of the City Code. As such the undersigned does hereby attest that the Consultant, its subsidiaries, assigns or principals have neither made a reportable contribution in the one year period preceding the date that the City Council awards the contract that would be deemed to be a violation of Section 3-51.1, nor will Counsel, its subsidiaries, assigns or principals make a reportable contribution during the term of the contract that would be in violation of Section 3-51.1.

20. Political Contribution Prohibition

This contract has been awarded to the Consultant based on the merits and abilities of the Consultant to provide the goods or services as described herein. This contract was not awarded through a "fair and open process" pursuant to N.J.S.A. 19:44A-20.4 et seq. As such, the undersigned does hereby attest that the Consultant, its subsidiaries, assigns or principals controlling in excess of 10% of the company has neither made a contribution, that is reportable pursuant to the Election Law Enforcement Commission pursuant to N.J.S.A. 19:44A-8 or 19:44A-16, in the one (1) year period preceding the award of the contract that would, pursuant to P.L. 2004, c.19, affect its eligibility to perform this contract, nor will it make a reportable contribution during the term of the contract to any political party committee in the City of Jersey City if a member of that political party is serving in an elective public office of the City of Jersey City when the contract is awarded, or to any candidate committee of any person serving in an elective public office of City of Jersey City when the contract is awarded.

21. Chapter 271 Political Contribution Disclosure

The Consultant is advised of its responsibility to file an annual disclosure statement on political contributions with the New Jersey Election Law Enforcement Commission (ELEC), pursuant to N.J.S.A. 19:44A-20.13 (P.L. 2005, c. 271, section 3) if the Consultant receives contracts in excess of \$50,000 from a public entity in a calendar year. It is the consultant's responsibility to determine if filing is necessary. Failure to so file can result in the imposition of financial penalties by ELEC. Additional information about this requirement is available from ELEC at 888-313-3532 or at www.elec.state.nj.us.

22. Compliance with Affirmative Action Plan

(a) If the Agreement exceeds \$36,000.00, it shall be subject to the Affirmative Action amendments to the Law Against Discrimination, N.J.S.A. 10:5-31 et seq.

(b) This Agreement shall not become effective and the Consultant shall provide no services under this Agreement until it has executed the following documents:

1. A supplemental Affirmative Action Agreement pursuant to N.J.S.A. 10:5-31 et seq. (for contracts which exceed \$36,000.00). The Affirmative Action Agreement is attached hereto as Exhibit "D" and is incorporated herein by reference.

2. An Affirmative Action Employee Information Report (form AA-302) (for contracts which exceed \$36,000.00).

IN WITNESS WHEREOF, the City has caused the Agreement to be signed by its duly authorized officers and its seal to here to affixed, and the Consultant has executed this Agreement on the date set forth above.

Robert J. Kakoleski, Business Administrator

Stacey Flanagan, DH&HS Director

ATTEST: _____

Robert Byrne, City Clerk

Paul Steffens, MA, LCADC
PRS Consultants, Inc.

ATTACHMENT A

PROGRAM DESCRIPTION: PRS Consultants, Inc – Company will provide a Licensed Clinical Alcohol and Drug Counselor (LCADC) to assume the responsibilities of the Jersey City Alliance Coordinator. Coordinator’s responsibilities will included but are not limited to: coordinating all grant-related activities; acting as Chairperson with respect to all grant subcontracting agency meetings; pre-approving all grant-related expenditures for processing and subsequent payment; preparing all required programmatic and fiscal reporting to the Hudson County Department of Human Services and the Governor’s Council on Alcoholism and Drug Abuse; actively participating in the Hudson County annual fiscal and programmatic site visit; and attending all Hudson County Alliance Steering Subcommittee (CASS) meetings.

PROJECT BUDGET:

<u>Categories</u>	<u>Initial Allocation</u>	<u>*Second Allocation</u>	<u>Total</u>
Personnel	_____	_____	_____
Consultant	<u>\$60,000.00</u>	_____	<u>\$60,000.00</u>
Space Costs	_____	_____	_____
Consumables	_____	_____	_____
Travel	_____	_____	_____
Equip. Rent/Lease	_____	_____	_____
Others (Specify)	_____	_____	_____
Totals	<u>\$60,000.00</u>	_____	<u>\$60,000.00</u>

(REVISED 4/13)

EXHIBIT A
MANDATORY EQUAL EMPLOYMENT OPPORTUNITY LANGUAGE
N.J.S.A. 10:5-31 et seq. (P.L. 1975, C. 127)
N.J.A.C. 17:27

GOODS, PROFESSIONAL SERVICE AND GENERAL SERVICE CONTRACTS

During the performance of this contract, the contractor agrees as follows:

The contractor or subcontractor, where applicable, will not discriminate against any employee or applicant for employment because of age, race, creed, color, national origin, ancestry, marital status, affectional or sexual orientation, gender identity or expression, disability, nationality or sex. Except with respect to affectional or sexual orientation and gender identity or expression, the contractor will ensure that equal employment opportunity is afforded to such applicants in recruitment and employment, and that employees are treated during employment, without regard to their age, race, creed, color, national origin, ancestry, marital status, affectional or sexual orientation, gender identity or expression, disability, nationality or sex. Such equal employment opportunity shall include, but not be limited to the following: employment, upgrading, demotion, or transfer; recruitment or recruitment advertising; layoff or termination; rates of pay or other forms of compensation; and selection for training, including apprenticeship. The contractor agrees to post in conspicuous places, available to employees and applicants for employment, notices to be provided by the Public Agency Compliance Officer setting forth provisions of this nondiscrimination clause.

The contractor or subcontractor, where applicable will, in all solicitations or advertisements for employees placed by or on behalf of the contractor, state that all qualified applicants will receive consideration for employment without regard to age, race, creed, color, national origin, ancestry, marital status, affectional or sexual orientation, gender identity or expression, disability, nationality or sex.

The contractor or subcontractor will send to each labor union, with which it has a collective bargaining agreement, a notice, to be provided by the agency contracting officer, advising the labor union of the contractor's commitments under this chapter and shall post copies of the notice in conspicuous places available to employees and applicants for employment.

The contractor or subcontractor, where applicable, agrees to comply with any regulations promulgated by the Treasurer pursuant to N.J.S.A. 10:5-31 et seq., as amended and supplemented from time to time and the Americans with Disabilities Act.

The contractor or subcontractor agrees to make good faith efforts to meet targeted county employment goals established in accordance with N.J.A.C. 17:27-5.2.

EXHIBIT A (Continuation)

The contractor or subcontractor agrees to inform in writing its appropriate recruitment agencies including, but not limited to, employment agencies, placement bureaus, colleges, universities, and labor unions, that it does not discriminate on the basis of age, race, creed, color, national origin, ancestry, marital status, affectional or sexual orientation, gender identity or expression, disability, nationality or sex, and that it will discontinue the use of any recruitment agency which engages in direct or indirect discriminatory practices.

The contractor or subcontractor agrees to revise any of its testing procedures, if necessary, to assure that all personnel testing conforms with the principles of job-related testing, as established by the statutes and court decisions of the State of New Jersey and as established by applicable Federal law and applicable Federal court decisions.

In conforming with the targeted employment goals, the contractor or subcontractor agrees to review all procedures relating to transfer, upgrading, downgrading and layoff to ensure that all such actions are taken without regard to age, race, creed, color, national origin, ancestry, marital status, affectional or sexual orientation, gender identity or expression, disability, nationality or sex, consistent with the statutes and court decisions of the State of New Jersey, and applicable Federal law and applicable Federal court decisions.

The contractor shall submit to the public agency, after notification of award but prior to execution of a goods and services contract, one of the following three documents:

Letter of Federal Affirmative Action Plan Approval

Certificate of Employee Information Report

Employee Information Report Form AA302 (electronically provided by the Division and distributed to the public agency through the Division's website at www.state.nj.us/treasury/contract_compliance)

The contractor and its subcontractors shall furnish such reports or other documents to the Division of Purchase & Property, CCAU, EEO Monitoring Program as may be requested by the office from time to time in order to carry out the purposes of these regulations, and public agencies shall furnish such information as may be requested by the Division of Purchase & Property, CCAU, EEO Monitoring Program for conducting a compliance investigation pursuant to **Subchapter 10 of the Administrative Code at N.J.A.C. 17:27.**

The undersigned vendor certifies on their company's receipt, knowledge and commitment to comply with:

EXHIBIT A
N.J.S.A. 10:5-31 and N.J.A.C. 17:27
MANDATORY EQUAL EMPLOYMENT OPPORTUNITY LANGUAGE
Goods, Professional Services and General Service Contracts
(Mandatory Affirmative Action Language)

The undersigned vendor further agrees to furnish the required forms of evidence and

understands that their contract/company's bid shall be rejected as non-responsive if said contractor fails to comply with the requirements of N.J.S.A. 10:5-31 and N.J.A.C. 17:27.

Representative's Name/Title (Print): PAUL STEFFENS - PRESIDENT
Representative's Signature: Paul Steffens
Name of Company: PAS CONSULTANTS, INC.
Tel. No.: 732/674-5464 Date: 5/12/14

Certification 17475

CERTIFICATE OF EMPLOYEE INFORMATION REPORT

RENEWAL

This is to certify that the contractor listed below has submitted an Employee Information Report pursuant to N.J.A.C. 17:27-1.1 et. seq. and the State Treasurer has approved said report. This approval will remain in effect for the period of

15-AUG-2008 to **15-AUG-2015**

PRS CONSULTANTS, INC
6 TUSCANY CIRCLE
MANCHESTER

NJ 08759

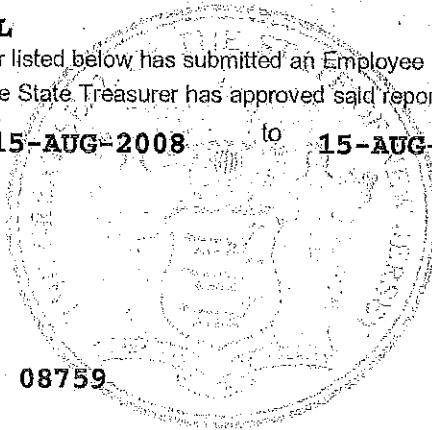

A handwritten signature in black ink is written over a horizontal line. The signature is stylized and appears to be "D. P. ...".

State Treasurer

APPENDIX A
AMERICANS WITH DISABILITIES ACT OF 1990
Equal Opportunity for Individuals with Disability

The contractor and the _____ of _____ (hereafter "owner") do hereby agree that the provisions of Title 11 of the Americans With Disabilities Act of 1990 (the "Act") (42 U.S.C. 5121 01 et seq.), which prohibits discrimination on the basis of disability by public entities in all services, programs, and activities provided or made available by public entities, and the rules and regulations promulgated pursuant thereto, are made a part of this contract. In providing any aid, benefit, or service on behalf of the owner pursuant to this contract, the contractor agrees that the performance shall be in strict compliance with the Act. In the event that the contractor, its agents, servants, employees, or subcontractors violate or are alleged to have violated the Act during the performance of this contract, the contractor shall defend the owner in any action or administrative proceeding commenced pursuant to this Act. The contractor shall indemnify, protect, and save harmless the owner, its agents, servants, and employees from and against any and all suits, claims, losses, demands, or damages, of whatever kind or nature, arising out of or claimed to arise out of the alleged violation. The contractor shall, at its own expense, appear, defend, and pay any and all charges for legal services and any and all costs and other expenses arising from such action or administrative proceeding or incurred in connection therewith. In any and all complaints brought pursuant to the owner's grievance procedure, the contractor agrees to abide by any decision of the owner which is rendered pursuant to said grievance procedure. If any action or administrative proceeding results in an award of damages against the owner, or if the owner incurs any expense to cure a violation of the ADA which has been brought pursuant to its grievance procedure, the contractor shall satisfy and discharge the same at its own expense.

The owner shall, as soon as practicable after a claim has been made against it, give written notice thereof to the contractor along with full and complete particulars of the claim. If any action or administrative proceeding is brought against the owner or any of its agents, servants, and employees, the owner shall expeditiously forward or have forwarded to the contractor every demand, complaint, notice, summons, pleading, or other process received by the owner or its representatives.

It is expressly agreed and understood that any approval by the owner of the services provided by the contractor pursuant to this contract will not relieve the contractor of the obligation to comply with the Act and to defend, indemnify, protect, and save harmless the owner pursuant to this paragraph.

It is further agreed and understood that the owner assumes no obligation to indemnify or save harmless the contractor, its agents, servants, employees and subcontractors for any claim which may arise out of their performance of this Agreement. Furthermore, the contractor expressly understands and agrees that the provisions of this indemnification clause shall in no way limit the contractor's obligations assumed in this Agreement, nor shall they be construed to relieve the contractor from any liability, nor preclude the owner from taking any other actions available to it under any other provisions of the Agreement or otherwise at law.

Representative's Name/Title Print: PAUL STEFFENS - PRESIDENT
Representative's Signature: Paul Steffens
Name of Company: PAS CONSULTANTS, INC.
Tel. No.: 732/674-5464 Date: 5/12/14

**Minority/Woman Business Enterprise (MWBE)
Questionnaire for Bidders**

Jersey City Ordinance C-829 establishes a goal of awarding 20% of the dollar amount of total city procurement to minority and woman owned business enterprises.

To assist us in monitoring our achievement of this goal, please indicate below whether your company is or is not a minority owned and/or woman owned business, and return this form with your bid proposal.

Business Name : PRS CONSULTANTS, INC.
Address : 6 TUSCANY CIR., MANCHESTER, NJ 08759
Telephone No. : 732-674-5464
Contact Name : PAUL STEFFENS

Please check applicable category :

Minority Owned Business (MBE) Minority & Woman Owned Business (MWBE)
 Woman Owned business (WBE) Neither

Definitions

Minority Business Enterprise

Minority Business Enterprise means a business which is a sole proprietorship, partnership or corporation at least 51% of which is owned and controlled by persons who are African American, Hispanic, Asian American, American Indian or Alaskan native, defined as follows:

African American: a person having origins in any of the black racial groups of Africa

Hispanic: a person of Mexican, Puerto Rican, Central or South American or other non-European Spanish culture or origin regardless of race.

Asian: a person having origins in any of the original peoples of the Far East, South East Asia, Indian subcontinent, Hawaii or the Pacific Islands.

American Indian or Alaskan Native: a person having origins in any of the original peoples of North America and who maintains cultural identification through tribal affiliation or community recognition.

Woman Business Enterprise

Woman Business Enterprise means a business which is a sole proprietorship, partnership or corporation at least 51% of which is owned and controlled by a woman or women.



STATE OF NEW JERSEY BUSINESS REGISTRATION CERTIFICATE

Taxpayer Name: P.R.S. CONSULTANTS, INC.
Trade Name:
Address: 6 TUSCANY CIRCLE
MANCHESTER, NJ 08759-6184
Certificate Number: 0576703
Effective Date: May 20, 1991
Date of Issuance: May 12, 2014

For Office Use Only:
20140512073408480

C. 271 POLITICAL CONTRIBUTION DISCLOSURE FORM

Required Pursuant To N.J.S.A. 19:44A-20.26

This form or its permitted facsimile must be submitted to the local unit no later than 10 days prior to the award of the contract.

Part I – Vendor Information

Vendor Name:	PRS Consultants, Inc.		
Address:	6 Tuscany Circle		
City:	Manchester	State:	N.J.
		Zip:	08759

The undersigned being authorized to certify, hereby certifies that the submission provided herein represents compliance with the provisions of N.J.S.A. 19:44A-20.26 and as represented by the Instructions accompanying this form.

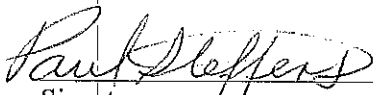
Signature

Paul Steffens
Printed Name

President
Title

Part II – Contribution Disclosure

Disclosure requirement: Pursuant to N.J.S.A. 19:44A-20.26 this disclosure must include all reportable political contributions (more than \$300 per election cycle) over the 12 months prior to submission to the committees of the government entities listed on the form provided by the local unit.

Check here if disclosure is provided in electronic form.

Contributor Name	Recipient Name	Date	Dollar Amount
Not Applicable			\$

Check here if the information is continued on subsequent page(s)

BUSINESS ENTITY DISCLOSURE CERTIFICATION
FOR NON-FAIR AND OPEN CONTRACTS
 Required Pursuant To N.J.S.A. 19:44A-20.8
CITY OF JERSEY CITY

Part I – Vendor Affirmation

The undersigned, being authorized and knowledgeable of the circumstances, does hereby certify that the <name of business entity> has not made and will not make any reportable contributions pursuant to N.J.S.A. 19:44A-1 et seq. that, pursuant to P.L. 2004, c. 19 would bar the award of this contract in the one year period preceding (date of award scheduled for approval of the contract by the governing body) to any of the following named candidate committee, joint candidates committee; or political party committee representing the elected officials of the City of Jersey City as defined pursuant to N.J.S.A. 19:44A-3(p), (q) and (r).

Election Fund for Steven Fulop (2013)	Frank Gajewski for Council
Team Fulop	Friends of Khemraj “Chico” Ramchal
Team Fulop Runoff	Councilperson Richard Boggiano
Lavarro for Council	Michael Yun for Council
Councilperson Joyce E. Watterman	Councilperson Candice Osborne
Councilperson Daniel Rivera	Diane Coleman for Council

Part II – Ownership Disclosure Certification

I certify that the list below contains the names and home addresses of all owners holding 10% or more of the issued and outstanding stock of the undersigned.

Check the box that represents the type of business entity:

- Partnership
 Corporation
 Sole Proprietorship
 Subchapter S Corporation
 Limited Partnership
 Limited Liability Corporation
 Limited Liability Partnership

Name of Stock or Shareholder	Home Address
Paul Steffens	6 Tuscany Circle, Manchester, New Jersey 08759
Rosemarie Steffens	6 Tuscany Circle, Manchester, New Jersey 08759

Part 3 – Signature and Attestation:

The undersigned is fully aware that if I have misrepresented in whole or part this affirmation and certification, I and/or the business entity, will be liable for any penalty permitted under law.

Name of Business Entity: PRS Consultants, Inc.

Signature of Affiant: Paul Steffens Title: President

Printed Name of Affiant : Paul Steffens Date: 5-12-14

Subscribed and sworn before me this 12 day
 of May, 2014.

My Commission expires:

Rosemarie Steffens
 (Witnessed or attested by)

Rosemarie Steffens - Secretary
 (Seal)

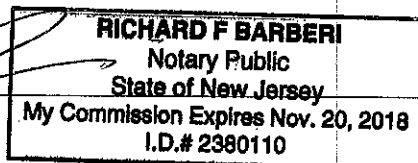

**CERTIFICATION OF COMPLIANCE WITH THE CITY OF JERSEY CITY
CONTRACTOR PAY-TO-PLAY REFORM ORDINANCE 08-128 ADOPTED
ON SEPTEMBER 3, 2008**

PART I - Vendor Affirmation

The undersigned, being authorized and knowledgeable of the circumstances, does hereby certify that PRS Consultants, Inc. (name of business entity) has not made any reportable contributions in the **one-year period preceding _____ (date City Council awards contract) that would be deemed to be violations of Section One of the City of Jersey City's Contractor Pay-to-Play Reform Ordinance 08-128 (attached hereto) and that would bar the award of this contract. I further certify that during the term of the contract PRS Consultants, Inc. (name of business entity) will not make any reportable contributions in violation of Ordinance 08-128.

PART II - Signature and Attestation:

The undersigned is fully aware that if I have misrepresented in whole or part this affirmation and certification, I and/or the business entity, will be liable for any penalty permitted under law.

Name of Business Entity: PRS Consultants, Inc.

Signed: *Paul Steffens* Title: President

Print Name: Paul Steffens Date: 5-12-14

Richard F Barberi
Subscribed and sworn before me
this day 12th of May, 2014.

Rosemarie Steffens
(Affiant)

My Commission expires:

RICHARD F BARBERI
Notary Public
State of New Jersey
My Commission Expires Nov. 20, 2018
I.D.# 2380110

Rosemarie Steffens – Secretary
(Print name & title of affiant) (Corporate Seal)

**Pursuant to Section 2 of Ordinance 08-128, no contributions or solicitation of contributions made prior to the effective date Ordinance 08-128 (September 23, 2008) shall be deemed to be a violation of the Ordinance

**State Of New Jersey
New Jersey Office of the Attorney General
Division of Consumer Affairs**

THIS IS TO CERTIFY THAT THE
Alcohol & Drug Counselor Committee

HAS LICENSED

Paul G. Steffens
6 Tuscany Circle
Manchester NJ 08759

FOR PRACTICE IN NEW JERSEY AS A(N): LCADC

New Jersey Office of the Attorney General
Division of Consumer Affairs
**THIS IS TO CERTIFY THAT THE
Alcohol & Drug Counselor Committee
HAS LICENSED.**
Paul G. Steffens
LCADC

06/01/2014 TO 07/31/2016
VALID
SIGNATURE *Paul G. Steffens*
ACTING DIRECTOR
License/Registration/Certificate #

06/01/2014 TO 07/31/2016
VALID

LICENSE/REGISTRATION/CERTIFICATION #

Paul G. Steffens
Signature of Licensee/Registrant/Certificate Holder

Paul G. L.
ACTING DIRECTOR

PLEASE DETACH HERE
IF YOUR LICENSE/REGISTRATION/
CERTIFICATE ID CARD IS LOST
PLEASE NOTIFY:
Alcohol & Drug Counselor Committee
P.O. Box 45040
Newark, NJ 07101

PLEASE DETACH HERE

Paul G. Steffens

EXPIRATION DATE 2016

YOUR LICENSE/REGISTRATION/CERTIFICATE NUMBER IS **37LC 00128100**. PLEASE USE IT IN ALL CORRESPONDENCE TO THE DIVISION OF CONSUMER AFFAIRS. USE THIS SECTION TO REPORT ADDRESS CHANGES. YOU ARE REQUIRED TO REPORT ANY ADDRESS CHANGES IMMEDIATELY TO THE ADDRESS NOTED BELOW.

Alcohol & Drug Counselor Committee
P.O. Box 45040
Newark, NJ 07101

PRINT YOUR NEW ADDRESS OF RECORD BELOW.
YOUR ADDRESS OF RECORD IS THE ADDRESS THAT WILL PRINT ON YOUR LICENSE/REGISTRATION/CERTIFICATE AND IT MAY BE MADE AVAILABLE TO THE PUBLIC.

PRINT YOUR NEW MAILING ADDRESS BELOW.
YOUR MAILING ADDRESS IS THE ADDRESS THAT WILL BE USED BY THE DIVISION OF CONSUMER AFFAIRS TO SEND YOU ALL CORRESPONDENCE.

HOME
BUSINESS

HOME
BUSINESS

TELEPHONE
INCLUDE AREA CODE

TELEPHONE
INCLUDE AREA CODE

If the law governing your profession requires the current license/registration/certificate to be displayed, it should be within reasonable proximity of your original license/registration/certificate at your principal office or place of business.

Resolution of the City of Jersey City, N.J.

City Clerk File No. Res. 14.487

Agenda No. 10.T

Approved: JUL 16 2014



TITLE:

RESOLUTION AWARDING A CONTRACT TO MUNICIPAL CODE CORPORATION TO PROVIDE CODIFICATION SERVICES FOR THE JERSEY CITY MUNICIPAL CODE

COUNCIL OFFERED AND MOVED ADOPTION OF
THE FOLLOWING RESOLUTION:

WHEREAS, the City of Jersey City (City) requires the services of a codifying company to prepare supplements to the City Code for ordinances enacted from August 1, 2014 through July 31, 2016; and

WHEREAS, Municipal Code Corporation, 1700 Capital Circle SW, P. O. Box 2235, Tallahassee, FL 32316 agrees to prepare and provide a PDF and on-line supplements to the Jersey City Municipal Code; and

WHEREAS, Municipal Code Corporation is qualified to perform these services and submitted a proposal dated July 7, 2014 indicating that it will provide the foregoing services based on the fee schedule set forth below; and

WHEREAS, N.J.S.A. 40A:11-5(1)(x) of the Local Public Contracts Law authorizes the award of contracts for printing, revising and codifying municipal ordinances without public advertising for bids and bidding therefor; and

WHEREAS, the City is acquiring these services directly and openly as a statutorily permitted contract pursuant to the provisions of N.J.S.A. 19:44A-20.5 (Pay-to-Play Law); and

WHEREAS, the City Clerk has determined and certified in writing that the value of the contract will exceed \$17,500; and

WHEREAS, Municipal Code Corporation has completed and submitted a Business Entity Disclosure Certification which certifies that Municipal Code Corporation has not made any reportable contributions to a political or candidate committee listed in the Business Entity Disclosure Certification in the previous one year, and that the contract will prohibit Municipal Code Corporation from making any reportable contributions during the term of the contract; and

WHEREAS, Municipal Code Corporation has submitted a Chapter 271 Political Contribution Disclosure Certification prior to the award of this contract; and

WHEREAS, Municipal Code Corporation has submitted its Certification of Compliance with the City's Contractor Pay-to-Play Reform Ordinance, Sec. 3-51.1; and

WHEREAS, funds are available in: Account No. 14-01-201-20-120-312; Purchase Order No. 114092; \$2,000.00; and

WHEREAS, the resolution authorizing the award and the contract itself must be available for public inspection.

NOW, THEREFORE, BE IT RESOLVED, by the Municipal Council of the City of Jersey City that:

- A. Subject to such modification as may be deemed necessary or appropriate by the Corporation Counsel, the Mayor or Business Administrator is authorized to execute a contract in substantially the form of the attached with Municipal Code Corporation for the preparation of supplements to the City Code for ordinances enacted from August 1, 2014 through July 31, 2016;
- B. The total contract amount is not to exceed \$40,000.00 and is based on the following fee schedule:
 1. Supplement Service Base Page Rate:
 - a. Single Column - 11 Point Times New Roman \$ 19.60 per page
 - b. Base page rate includes:
 - (1) Acknowledgment of Material
 - (2) Data conversion, as necessary
 - (3) Editorial Work
 - (4) Proofreading
 - (5) Indexing
 - (6) Schedule as selected by Client
 - (7) Updating Internet
 - (8) Providing a PDF of each supplement

TITLE:

RESOLUTION AWARDING A CONTRACT TO MUNICIPAL CODE CORPORATION TO PROVIDE CODIFICATION SERVICES FOR THE JERSEY CITY MUNICIPAL CODE

- 2. Additional Services that apply to Supplement Service:
 - a. Code on the Internet plus CodeBank (August to July annual fee) \$ 900.00
 - b. Graphics and tabular matter; per graphic or table \$ 10.00
 - c. Freight Actual freight
 - d. New Ordinances on the Web (NOW - August to July annual fee) \$2,000.00
 - e. OrdBank (August to July annual fee) \$1,000.00
 - f. XML Export for integration with Spatial Data Logic, per delivery \$ 75.00
- 3. Payment for Supplement and Additional Services
 - a. Invoices to be submitted upon shipment of Project(s)/Supplement(s)
 - b. Payment of invoices to be made via Partial Payment Vouchers
- C. The term of the contract shall be two years commencing on August 1, 2014 and ending on July 31, 2016.
- D. The award of this contract is made without public bidding pursuant to N.J.S.A. 40A:11-5(1)(x) of the Local Public Contracts Law.
- E. Upon certification by an official or employee of the City authorized to attest that the contractor has complied with the contract specifications in all respects, and the requirements of the contract met, then payment to the contractor shall be made in accordance with the provisions of the Local Fiscal Affairs Law, N.J.S.A. 40A:5-1 et seq.
- F. The award of this contract shall be subject to the condition that the contractor provide satisfactory evidence of compliance with the Affirmative Action Amendments to the Law Against Discrimination N.J.S.A. 10:5-31 et seq.
- G. The total cost of the contract shall not exceed \$40,000.00. In accordance with N.J.A.C. 5:30-5.5(a), the continuation of this contract after the expenditure of funds encumbered under this resolution shall be subject to the availability and appropriation of sufficient funds in the 2014 calendar fiscal year temporary and permanent budgets and in the subsequent fiscal year budgets.
- H. The Business Entity Disclosure Certification, Chapter 271 Political Contribution Disclosure Certification, the Determination of Value Certification and Certification of Compliance with the City's Pay-to-Play Ordinance, attached hereto and incorporated herein by reference, shall be placed on file with this resolution.

I hereby certify that funds in the amount of \$2,000.00 are available in Account No. 14-01-201-20-120-312 for payment of this resolution. *P.O. #114092*

Donna Mauer
Donna Mauer, Chief Financial Officer

APPROVED: *[Signature]*
APPROVED: *[Signature]* Business Administrator
ASST

APPROVED AS TO LEGAL FORM
[Signature] Corporation Counsel
Certification Required

Not Required

APPROVED 9-0

in G:\WPDOCS\SEAN\MUNICIPAL CODE CORPORATION\Contract2014\RESO (2014) TO AWARD CONTRACT.wpd

RECORD OF COUNCIL VOTE ON FINAL PASSAGE 7.16.14											
COUNCILPERSON	AYE	NAY	N.V.	COUNCILPERSON	AYE	NAY	N.V.	COUNCILPERSON	AYE	NAY	N.V.
GAJEWSKI	✓			YUN	✓			RIVERA	✓		
RAMCHAL	✓			OSBORNE	✓			WATTERMAN	✓		
BOGGIANO	✓			COLEMAN	✓			LAVARRO, PRES	✓		

✓ Indicates Vote N.V.-Not Voting (Abstain)

Adopted at a meeting of the Municipal Council of the City of Jersey City N.J.

[Signature]
Rolando R. Lavarro, Jr., President of Council

[Signature]
Robert Byrne, City Clerk

DETERMINATION OF VALUE CERTIFICATION

Robert Byrne, of full age, hereby certifies as follows:

1. As City Clerk of the City of Jersey City (City), I am responsible for the codification of the City's Ordinances and supplements thereto.
2. The City requires the services of a codifying company to prepare supplements to the City Code for ordinances enacted from August 1, 2014 through July 31, 2016.
3. N.J.S.A. 40A:11-5(1)(x) of the Local Public Contracts Law authorizes the award of contracts for printing, revising and codifying municipal ordinances without public advertising for bids and bidding therefor.
4. As Municipal Clerk for the City of Jersey City I recommend award of the contract to Municipal Code Corporation.
5. The term of the contract is two years effective as of August 1, 2014.
6. The estimated amount of the contract exceeds \$17,500.00.
7. This certification is made pursuant to N.J.S.A. 19:44A-20.5.
8. I certify that the foregoing statements are true. I am aware that if any of the foregoing statements made by me are willfully false, I am subject to punishment.

Dated: 7/8/14



Robert Byrne, City Clerk



municode

Municipal Code Corporation • PO Box 2235 Tallahassee, FL 32316
info@municode.com • 800.262.2633
fax 850.575.8852 • www.municode.com

July 7, 2014

Ms. Irene McNulty
Administrative Secretary to the Clerk
City of Jersey City
280 Grove Street
Jersey City, New Jersey 07302

Sent Via Email: mcnulty1@icnj.org

RECEIVED
2014 JUL - 9 A 9:49
CITY CLERK'S OFFICE
JERSEY CITY, N.J.

Dear Ms. McNulty:

Thank you so much for speaking with our Regional Sales Representative, Gregory Dudiak, and for your interest in allowing Municipal Code Corporation (Municode) to update and maintain the City Code.

Please review the contract for proposed services and any additional services of interest. If you have any questions or desire additional information, please call and speak with Gregory or me.

The Supplement Service will be in full force and effect for a period of two (2) years.

We truly value your business. If you have any questions or desire additional information, please call and speak with Gregory or me. We will also be happy to schedule a conference call or webinar with all interested parties, or meet with you personally.

Sincerely,

Stefanie Rasmussen
Assistant VP Sales

ALL/swr
Enc.
gdudiak@municode.com

PROPOSAL FOR CONTRACT WITH THE CITY OF JERSEY CITY, NEW JERSEY

SCOPE OF WORK

MUNICIPAL CODE CORPORATION, a corporation duly organized and existing under the laws of the State of Florida, hereinafter referred to as Municode, hereby offers to perform supplementation services for the **CITY OF JERSEY CITY, NEW JERSEY**, hereinafter referred to as Client.

1. **Services Offered.** Municode will research, edit, index and publish (both in print and electronically) the finally enacted legislation Client specifies for inclusion in the Code.
2. **Material Included.** All legislation of a general and permanent nature, passed in final form by the Client will be included in the Code. Municode prefers the material in an editable electronic format (such as WORD), and will rely upon the electronic media furnished by the Client. All material received by Municode will be acknowledged via e-mail. Ordinances contained within the text of minutes can be researched and extracted.
3. **Omitted Material.** The following legislation, which is not of a general and permanent nature, will be omitted from the Code unless Client instructs otherwise: Appropriations; Franchises; Bonds; Vacating Streets and Other Public Properties; Sales of Surplus Assets and Properties; Tax Levies; Special Elections; Contracts and Agreements; Rezoning; Personnel Regulations; Annexations and Disannexations; Tax Anticipated Notes and Issuances of Similar Debt Instruments; Appointments of Named Individuals to Positions within a Governmental Body; Comprehensive Master Plans and Traffic Schedules and Fee Schedules.
4. **Additional Content.** Client can include additional content (for example, charter, zoning, SmartCode or Form Based Code, land development regulations) in the Code. The native files (typically InDesign) will be required of any graphic-intensive content. Added content can be included in a Supplement or published separately. Additional divider tabs or binders will be provided as necessary.
5. **Editorial Work.** The Supplement editorial team, who is supervised by a licensed attorney and consists of a legal editor, proofreader and indexer, will review the legislation to determine proper placement within the Code. Municode will adhere to the structure and style contained in the ordinance unless changes are required to ensure consistency with other text in the Code. The team will also update the Table of Contents, catch lines, reference tables and index. Editorial notes will be appended to sections that require additional explanation. Municode has Supplement teams trained in the use of InDesign, and will editorially preserve the integrity of form of such files whether displayed on-line or in print.
6. **Schedule.** Amendments are provided on a schedule designed to meet the needs of the Client. The schedule can be weekly, biweekly, monthly, bi-monthly, quarterly, tri-annual, semi-annual, annual or upon authorization. Electronic Updates can occur on a more frequent schedule than Printed Supplements. In addition to establishing when Supplements will occur, the schedule determines how frequently Municode will request ordinances from Client. The City is currently set up with a Quarterly schedule and it can be adjusted anytime.
7. **Printed Supplements.** Amendments to the printed Code occur in the form of printed Supplement pages that are issued as replacement pages on acid-free paper. Printed Supplements include: an updated Table of Contents; Code Comparative Table; index; an instruction sheet to advise holders of the book where to insert and remove pages; a Checklist of Up-To-Date pages that indicates the most recent source from which each page is derived; and a Supplement History Table that indicates the specific ordinances included in the Supplement. A copy of each Supplement for every printed Code is included in the base page rate. Our paper supplier is chain-of-custody certified with the Forest Stewardship Council (FSC), Sustainable Forest Initiative (SFI) and Program for Endorsement of Forest Certification schemes (PEFC).
8. **Electronic Updates.** Amendments to the Internet version of the Code can be provided on a separate schedule from Printed Supplements. Electronic Updates reflect the editorial decisions made by the Supplement team and a fully searchable, complete Code will be posted. Electronic Updates are included in the base page rate and clients who receive both Electronic Updates and Printed Supplements receive the Printed Supplements at no charge.

9. **Electronic Medium and Format.** The Code can be furnished in any electronic medium and format selected by the Client. The delivery mediums are: Internet, Download and FTP. Most popular formats are: HTML, RTF, PDF, FOLIO and integrated with search engine.
10. **Support.** Support for our electronic and online services is offered 8:00a to 8:00p (Eastern). Telephone requests are answered within 24 hours, and e-mail requested within one hour.
11. **Delivery.** Printed Supplements to the Code will be delivered in bulk to the Client, unless Client chooses to utilize Municode's Distribution Services. The website will be updated upon shipment of the printed supplement or as Electronic Updates are completed.
12. **Distribution.** With Municode as Total Code Administrator option (TCA), we provide inventory for sale (Codes and/or reprint pamphlets) and we provide all services for outside subscribers. The TCA service is provided at no cost to you and totally at our expense.

MUNICODE'S WEBSITE SERVICES DEFINED

Code on Internet includes the following features:

- ☞ Mobile Friendly Site: Automatically downloads to iOS, Blackberry, Android and Windows;
- ☞ Save as Word (DOCX);
- ☞ Saved Searching;
- ☞ Print and Email: Print, Save, Email one or more Sections, Chapters and whole Titles;
- ☞ Internal Linking within the Code where cited;
- ☞ Mouseover Preview (or Pop ups);
- ☞ Static Linking: Copy links of any Section, Chapter or Title to share via email or social media;
- ☞ Pinpoint Searching: Ordinance searching included, search one or more Sections, Chapters & whole Titles;
- ☞ Scrolling Tables and Charts: Header stays fixed while you scroll through the table/chart;
- ☞ GIS - Municode can provide a permalink to any code section and assist your staff to create a link from their GIS system to relevant code sections.
- ☞ Collapsible TOC (Frameless Version);
- ☞ In-line Images and PDFs;
- ☞ Current Location Status Banner (breadcrumb trail) present while searching Code;
- ☞ Server Stability and Disaster Recovery Plan;
- ☞ ***Co-Location in Atlanta, Georgia: only Codification Company to have geo-redundant servers in multiple states;***
- ☞ Phone, email and Web support for Citizens and Staff: 24 hour email response; Phone support from 8:00 am to 8:00 pm Eastern Standard Time.

OrdBank. Creates a permanent, online collection of all ordinances sent to Municode; Prior to incorporation into your Code via supplementation, all of your ordinances will be posted on your landing page for easy access. Once codified, each ordinance History Note is hyperlinked to the actual ordinance as enacted. OrdBank saves your municipality valuable time and money by enabling you, your staff and your citizens to gain instant access to your ordinances by simply clicking the history note.

OrdLink + OrdBank. Prior to incorporation into your Code via supplementation, OrdLink hyperlinks newly adopted ordinances to the section being amended. Linked sections are highlighted in the Table of Contents and links are created from the amended sections to the new ordinances. Once the linked ordinances are incorporated into the Code, they added to your OrdBank and hyperlinked to your History Notes. For the linked ordinances to be searchable, they must be sent in an editable format. Scanned documents can be included in the list and are viewable, but not searchable.

CodeBank. Creates a permanent, online collection of all past versions of your Code. CodeBank enables your online users to easily access previous versions of your Code. The historic version of your Code is fully searchable and printable, making the task of researching past versions of your Code more efficient. For your convenience, when a previous version of your Code is selected, users are alerted that they are looking at an older version of your Code.

Coming Soon CodeBank Compare. This service provides the users the ability to select a past version of the online Code and compare it to any other version of the Code each time the Code is updated. The differences will be shown via Highlights (added material) or Strikethrough (deleted material).

Coming Soon eNotify. A notice of recent amendments to the Charter and Code for the specific Title, Chapter, Article will be sent to the enrolled user each time the online code is updated.

MuniDocs. Enables municipal users to send material of your choosing directly to Municode to upload documents to your online Code of Ordinances. Let Municode do all the work and upload the versions of Minutes, Resolutions, Budgets, and or any other non-code material online. Your collection of documents to be posted alongside your Code and will be fully searchable, filterable for ease of use.

MuniPRO. MuniPro Searching allows you to search all of the Codes we host (the entire country, a single state, or individually selected Codes of your choosing). MuniPro Searches are ideal for researching local regulations of special interest, or to find out how other communities are dealing with similar issues. There is a per annum fee for this premium service; User Name and Password required. If the IP based model is selected, only Multiple Code Searching is available. MuniPRO provides subscribers with the following tools:

- ③ **Multiple Code Search.** Search all codes within one state, multiple codes within one state, or search all codes in the entire U.S.! Search results are sorted by relevancy and indicate the source publication, showing excerpts and keyword highlighting.
- ③ **MuniPRO Favorites.** Create a "favorites" list of frequently visited Codes or sections. This will save time by making navigation a one-click process from your Dashboard.
- ③ **MuniPRO Notes.** Create a note and attach it to any document in any publication. Note icons will show in both the Table of Contents and search results page, alerting the user to a previously written note. Notes can be shown or hidden when browsing and searching a publication, and a global listing of notes can be accessed with a single click from your Dashboard.
- ③ **MuniPRO Drafts.** Begin a new ordinance draft to keep track of pending legislation. Drafts icons will appear in the Table of Contents and search results, and can also be accessed from a single click.

Custom Banner. Municode will customize the look and feel of your Code on municode.com to more closely match your municipal web site. This is accomplished by posting a banner image (provided by the client) over the top portion of our site.

Mobile Friendly Site. The Municode.com Online Library includes a mobile friendly version of your Code. This is a frameless version that is accessible from your mobile device and is formatted for a better viewing experience on today's modern Smartphones. Our website recognizes when a visitor is viewing the content on a mobile device and automatically changes the view to maximize the capabilities of the hand-held device. *This feature is included in your annual Internet fee.*

Email (from the Web). Chapters, Articles or individual Sections may be selected for emailing. The functionality is intuitive and *included in your annual Internet fee.*

Print or Save. Similar to Emailing, Chapters, Articles or individual Sections may be selected for Printing or Saving. Save (as compared to "blocking & copying") preserves the formatting when the document is edited using your word processing software. *These features are offered to you as part of your annual Code on the Internet fee.*

Internal Cross Reference Linking. Cross references within the Code will be linked to their respective destination Article, Chapter, or Section. *This feature is offered to you as part of your annual Code on the Internet fee.*

Mouseover (cluetips). Navigate to a code and any linked cross reference will display the pop-up after a 1 second delay. You'll need to clear your browser cache to enable them (Tools -> Internet Options -> Delete -> Temporary Internet Files). *This feature is offered to you as part of your annual Code on the Internet fee.*

Static Linking to your Code. Each level of the code has a static link that will enable your users to easily create "Hot Links" to any section of the code. Simply click the permalink icon to the right of each heading level and paste the URL into the destination of your choice. *This feature is offered to you as part of your annual Code on the Internet fee.*

Pinpoint Searching. Easily search any individual Code with our advanced search options: revisit previously conducted searches using the "Search History" button; or narrow the scope of your search to find more specific legislation. *Once again these features are offered to you as part of your annual Code on the Internet fee.*

Scrolling Tables and Charts. The header stays fixed to the top of your browsing pane while you scroll through your tables and charts.

GIS. Municode can provide a permalink to any code section and assist staff members to create links from their GIS system to relevant code sections.

Collapsible TOC. The Table of Contents collapses and is re-sizeable providing additional real estate with which you may view your code. Easily view your maps, graphs and charts by simply enlarging the item. This feature *is included in your annual Code on the Internet fee.*

In-line Images & PDFs. Municode takes great care to ensure that your images match online and in print, and are captured at the highest quality possible. Our online graphics can be enlarged with a frameless view to maximize the image. Municode can also incorporate PDFs of certain portions of the Code that have very specific viewing and layout requirements. These PDFs are fully searchable within our search engine, and are typically utilized with form-based Land Development Codes. *This service is included in your annual Code on the Internet fee.*

Internet Stability. Municode houses its public facing websites in a secure, SAS70, PCI compliant data center owned and operated by Peak 10 in Atlanta, Georgia. This page outlines the features of Peak 10's datacenter, including redundant Internet providers, redundant power and cooling, and secure biometric access to the physical facility (<http://www.peak10.com/locations/atlanta/facility1>). All systems are backed up and synchronized between our Tallahassee, Florida and Atlanta, Georgia locations for full geographic redundancy should one of the sites become inaccessible.

SUPPLEMENTATION QUOTATION SHEET FOR THE CITY OF JERSEY CITY, NEW JERSEY

Supplement Service Base Page Rate¹

Page Format	Base Page Rate
Single Column, 11-point Times New Roman font	\$19.60 per page

Base page rate above includes:

- Acknowledgement of Material
- Data conversion, as necessary
- Editorial Work
- Proofreading
- Indexing
- Schedule as selected by Client², Currently Quarterly
- Updating Internet
- Providing a PDF copy

Additional Services that may apply to Supplement Service:

- | | |
|---|--------------------|
| • Code on Internet + CodeBank (August - July annually) | \$900 ³ |
| • Graphics ⁴ & Tabular ⁵ matter, per graphic or table | \$10 |
| • Blank Pages | No Charge |
| • Freight ⁶ | Actual freight |
| • State Sales Tax | If applicable |
| • New Ordinances on the Web (NOW), annual fee | |
| August 2014 – July 2015 | \$1,834 |
| August 2015 – July 2016 | \$2,000 |
| • OrdBank ⁷ , annual fee | |
| August 2014 – July 2015 | \$917 |
| August 2015 – July 2016 | \$1,000 |
| • XML Export for integration with Spatial Data Logic, per delivery ⁸ | \$75 |

Payment for Supplements and Additional Services

- Invoices will be submitted upon shipment of project(s).

Term of Agreement. This Agreement shall begin August 1, 2014 and end two (2) years from then on July 31, 2016.

¹ All prices quoted in this section may be increased no more frequently than annually in accordance with the Producer Price Index – Internet Publishing and web search portals (NAICS 519130) as reported by US Department of Labor – Bureau of Labor Statistics.

² Schedule for Supplements can be weekly, biweekly, monthly, bi-monthly, quarterly, tri-annual, semi-annual, annual or upon authorization. Electronic Updates can occur more frequently than printed Supplements.

³ Code on the Internet fee is \$750 and CodeBank is \$150 for a total of \$900.

⁴ Includes printing all copies. Additional \$15 fee if graphic includes color.

⁵ Tabular matter is defined as tables, Algebra formulae, or other materials that require special programs or extra editorial time to modify and prepare for inclusion in an update.

⁶ Freight charges will only apply if the City orders printed copies of the Code or Supplements.

⁷ OrdBank requires participation in NOW or OrdLink service.

⁸ "delivery" is defined as making updated electronic data available to the Client on CD-ROM, FTP. Fee applies whenever updated content is delivered via one of the above-defined products.

**CERTIFICATION OF COMPLIANCE WITH THE CITY OF JERSEY CITY
CONTRACTOR PAY-TO-PLAY REFORM ORDINANCE 08-128 ADOPTED
ON SEPTEMBER 3, 2008**

PART I - Vendor Affirmation

The undersigned, being authorized and knowledgeable of the circumstances, does hereby certify that Municipal Code Corporation (name of business entity) has not made any reportable contributions in the **one-year period preceding _____ (date City Council awards contract) that would be deemed to be violations of Section One of the City of Jersey City's Contractor Pay-to-Play Reform Ordinance 08-128 (attached hereto) and that would bar the award of this contract. I further certify that during the term of the contract Municipal Code Corporation (name of business entity) will not make any reportable contributions in violation of Ordinance 08-128.

PART II - Signature and Attestation:

The undersigned is fully aware that if I have misrepresented in whole or part this affirmation and certification, I and/or the business entity, will be liable for any penalty permitted under law.

Name of Business Entity: Municipal Code Corporation

Signed: [Signature] Title: Chairman/CEO

Print Name: A. Lanton Langford Date: 7/2/2014

Subscribed and sworn before me
this 2nd day of July, 2014.
My Commission expires:

Nov 8, 2014

[Signature]
(Affiant)
Melissa K. Robbins Notary
(Print name & title of affiant) (Corporate Seal)

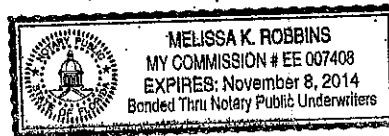

**Pursuant to Section 2 of Ordinance 08-128, no contributions or solicitation of contributions made prior to the effective date Ordinance 08-128 (September 23, 2008) shall be deemed to be a violation of the Ordinance.

BUSINESS ENTITY DISCLOSURE CERTIFICATION
 FOR NON-FAIR AND OPEN CONTRACTS
 Required Pursuant To N.J.S.A. 19:44A-20.8
 CITY OF JERSEY CITY

Part I – Vendor Affirmation

The undersigned, being authorized and knowledgeable of the circumstances, does hereby certify that the <name of business entity> has not made and will not make any reportable contributions pursuant to N.J.S.A. 19:44A-1 et seq. that, pursuant to P.L. 2004, c. 19 would bar the award of this contract in the one year period preceding (date of award scheduled for approval of the contract by the governing body) to any of the following named candidate committee, joint candidates committee; or political party committee representing the elected officials of the <name of entity of elected officials> as defined pursuant to N.J.S.A. 19:44A-3(p), (q) and (r).

Election Fund for Steven Fulop (2013)	Frank Gajewski for Council
Team Fulop	Friends of Khemraj “Chico” Ramchal
Team Fulop Runoff	Councilperson Richard Boggiano
Lavarro for Council	Michael Yun for Council
Councilperson Joyce E. Watterman	Councilperson Candice Osborne
Councilperson Daniel Rivera	Diane Coleman for Council

Part II – Ownership Disclosure Certification

I certify that the list below contains the names and home addresses of all owners holding 10% or more of the issued and outstanding stock of the undersigned.

Check the box that represents the type of business entity:

- Partnership
 Corporation
 Sole Proprietorship
 Subchapter S Corporation
 Limited Partnership
 Limited Liability Corporation
 Limited Liability Partnership

Name of Stock or Shareholder	Home Address
A. Lawton Langford	5002 Brill point, Tallahassee FL 32312
George R. Langford	837 Lake Ridge Road, Tallahassee FL 32312

Part 3 – Signature and Attestation:

The undersigned is fully aware that if I have misrepresented in whole or part this affirmation and certification, I and/or the business entity, will be liable for any penalty permitted under law.

Name of Business Entity: Municipal Code Corporation
 Signed: [Signature] Title: Chairman / CEO
 Print Name: A. Lawton Langford Date: 7/2/2014

Subscribed and sworn before me this 2nd day of July, 2014
 My Commission expires: Nov 8, 2014
[Signature]
 (Affiant)
Melissa K. Robbins, Notary
 (Print name & title of affiant) (Corporate Seal)

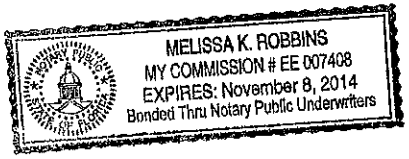

C. 271 POLITICAL CONTRIBUTION DISCLOSURE FORM

Required Pursuant To N.J.S.A. 19:44A-20.26

This form or its permitted facsimile must be submitted to the local unit no later than 10 days prior to the award of the contract.

Part I - Vendor Information

Vendor Name:	Municipal Code Corporation		
Address:	PO Box 2225		
City:	Tallahassee	State:	FL
		Zip:	32316

The undersigned being authorized to certify, hereby certifies that the submission provided herein represents compliance with the provisions of N.J.S.A. 19:44A-20.26 and as represented by the Instructions accompanying this form.

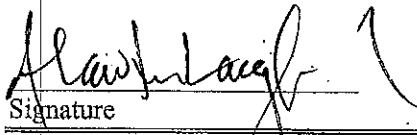
	A. Lanton Langford	Chairman/ CEO
Signature	Printed Name	Title

Part II - Contribution Disclosure

Disclosure requirement: Pursuant to N.J.S.A. 19:44A-20.26 this disclosure must include all reportable political contributions (more than \$300 per election cycle) over the 12 months prior to submission to the committees of the government entities listed on the form provided by the local unit.

Check here if disclosure is provided in electronic form.

Contributor Name	Recipient Name	Date	Dollar Amount
			\$
N/A	N/A		

Check here if the information is continued on subsequent page(s)

EXHIBIT A (Continuation)

The contractor or subcontractor agrees to inform in writing its appropriate recruitment agencies including, but not limited to, employment agencies, placement bureaus, colleges, universities, and labor unions, that it does not discriminate on the basis of age, race, creed, color, national origin, ancestry, marital status, affectional or sexual orientation, gender identity or expression, disability, nationality or sex, and that it will discontinue the use of any recruitment agency which engages in direct or indirect discriminatory practices.

The contractor or subcontractor agrees to revise any of its testing procedures, if necessary, to assure that all personnel testing conforms with the principles of job-related testing, as established by the statutes and court decisions of the State of New Jersey and as established by applicable Federal law and applicable Federal court decisions.

In conforming with the targeted employment goals, the contractor or subcontractor agrees to review all procedures relating to transfer, upgrading, downgrading and layoff to ensure that all such actions are taken without regard to age, race, creed, color, national origin, ancestry, marital status, affectional or sexual orientation, gender identity or expression, disability, nationality or sex, consistent with the statutes and court decisions of the State of New Jersey, and applicable Federal law and applicable Federal court decisions.

The contractor shall submit to the public agency, after notification of award but prior to execution of a goods and services contract, one of the following three documents:

Letter of Federal Affirmative Action Plan Approval

Certificate of Employee Information Report

* Employee Information Report Form AA302 (electronically provided by the Division and distributed to the public agency through the Division's website at www.state.nj.us/treasury/contract_compliance)

The contractor and its subcontractors shall furnish such reports or other documents to the Division of Purchase & Property, CCAU, EEO Monitoring Program as may be requested by the office from time to time in order to carry out the purposes of these regulations, and public agencies shall furnish such information as may be requested by the Division of Purchase & Property, CCAU, EEO Monitoring Program for conducting a compliance investigation pursuant to **Subchapter 10 of the Administrative Code at N.J.A.C. 17:27.**

The undersigned vendor certifies on their company's receipt, knowledge and commitment to comply with:

EXHIBIT A
N.J.S.A. 10:5-31 and N.J.A.C. 17:27
MANDATORY EQUAL EMPLOYMENT OPPORTUNITY LANGUAGE
Goods, Professional Services and General Service Contracts
(Mandatory Affirmative Action Language)

The undersigned vendor further agrees to furnish the required forms of evidence and

understands that their contract/company's bid shall be rejected as non-responsive if said contractor fails to comply with the requirements of N.J.S.A. 10:5-31 and N.J.A.C. 17:27.

Representative's Name/Title (Print): Michelle S. Eagen CFO
Representative's Signature: Michelle S. Eagen CFO
Name of Company: Municipal Code Corporation
Tel. No.: 850-576-3171 Date: 7-2-2014

STATE OF NEW JERSEY
Division of Purchase & Property
Contract Compliance Audit Unit
EEO Monitoring Program

EMPLOYEE INFORMATION REPORT

IMPORTANT-READ INSTRUCTIONS CAREFULLY BEFORE COMPLETING FORM. FAILURE TO PROPERLY COMPLETE THE ENTIRE FORM AND TO SUBMIT THE REQUIRED \$150.00 FEE MAY DELAY ISSUANCE OF YOUR CERTIFICATE. DO NOT SUBMIT EEO-1 REPORT FOR SECTION B, ITEM 11. For instructions on completing the form, go to: http://www.state.nj.us/treasury/contract_compliance/pdf/aa302ins.pdf

SECTION A - COMPANY IDENTIFICATION

1. FID. NO. OR SOCIAL SECURITY	2. TYPE OF BUSINESS <input type="checkbox"/> 1. MFG <input checked="" type="checkbox"/> 2. SERVICE <input type="checkbox"/> 3. WHOLESALE <input type="checkbox"/> 4. RETAIL <input type="checkbox"/> 5. OTHER	3. TOTAL NO. EMPLOYEES IN THE ENTIRE COMPANY 131
4. COMPANY NAME MUNICIPAL CODE CORPORATION		
5. STREET 1700 CAPITAL CIRCLE SW	CITY TALLAHASSEE	COUNTY LEON
	STATE FL	ZIP CODE 32310
6. NAME OF PARENT OR AFFILIATED COMPANY (IF NONE, SO INDICATE)		
7. CHECK ONE: IS THE COMPANY: <input checked="" type="checkbox"/> SINGLE-ESTABLISHMENT EMPLOYER <input type="checkbox"/> MULTI-ESTABLISHMENT EMPLOYER		
8. IF MULTI-ESTABLISHMENT EMPLOYER STATE THE NUMBER OF ESTABLISHMENTS IN NJ <input type="text" value="0"/>		
9. TOTAL NUMBER OF EMPLOYEES AT ESTABLISHMENT WHICH HAS BEEN AWARDED THE CONTRACT <input type="text" value="131"/>		
10. PUBLIC AGENCY AWARDED CONTRACT		

Official Use Only	DATE RECEIVED	INAUG. DATE	ASSIGNED CERTIFICATION NUMBER

SECTION B - EMPLOYMENT DATA

11. Report all permanent, temporary and part-time employees ON YOUR OWN PAYROLL. Enter the appropriate figures on all lines and in all columns. Where there are no employees in a particular category, enter a zero. Include ALL employees, not just those in minority/non-minority categories, in columns 1, 2, & 3. **DO NOT SUBMIT AN EEO-1 REPORT.**

JOB CATEGORIES	ALL EMPLOYEES			PERMANENT MINORITY/NON-MINORITY EMPLOYEE BREAKDOWN									
	COL. 1 TOTAL (Cols.2 & 3)	COL. 2 MALE	COL. 3 FEMALE	***** MALE*****					***** FEMALE*****				
				BLACK	HISPANIC	AMER. INDIAN	ASIAN	NON MIN.	BLACK	HISPANIC	AMER. INDIAN	ASIAN	NON MIN.
Officials/ Managers	8	6	2					6					2
Professionals	47	14	33	2				12	2				31
Technicians	18	11	7	1	1			9	1				6
Sales Workers	7	6	1					6					1
Office & Clerical	39	6	33	1				5	3		1		29
Craftworkers (Skilled)	3	2	1	1				1					1
Operatives (Semi-skilled)													
Laborers (Unskilled)	6	3	3	1				2					3
Service Workers													
TOTAL	128	48	80	6	1			41	6		1		73
Total employment From previous Report (if any)	147	61	86	8	2		1	50	9		1	2	74
Temporary & Part-Time Employees	The data below shall NOT be included in the figures for the appropriate categories above.												
	3	3		1				2					

12. HOW WAS INFORMATION AS TO RACE OR ETHNIC GROUP IN SECTION B OBTAINED <input type="checkbox"/> 1. Visual Survey <input checked="" type="checkbox"/> 2. Employment Record <input type="checkbox"/> 3. Other (Specify)	14. IS THIS THE FIRST Employee Information Report Submitted? 1. YES <input type="checkbox"/> 2. NO <input checked="" type="checkbox"/>	15. IF NO, DATE LAST REPORT SUBMITTED MO. DAY YEAR 07 12 2013
13. DATES OF PAYROLL PERIOD USED From: 06/16/2014 To: 06/29/2014		

SECTION C - SIGNATURE AND IDENTIFICATION

16. NAME OF PERSON COMPLETING FORM (Print or Type) MICHELLE S. EAGEN	SIGNATURE <i>Michelle S. Eagen</i>	TITLE CFO	DATE MO DAY YEAR 07 02 2014
17. ADDRESS NO. & STREET 1700 CAPITAL CIRCLE SW	CITY TALLAHASSEE	COUNTY LEON	STATE FL
	ZIP CODE 3230	PHONE (AREA CODE, NO., EXTENSION) 850 - 576 - 3171	

* Subsidiary Company figures removed from the 2013 report.

APPENDIX A
AMERICANS WITH DISABILITIES ACT OF 1990
Equal Opportunity for Individuals with Disability

The contractor and the CEO of municipal code corporation (hereafter "owner") do hereby agree that the provisions of Title 11 of the Americans With Disabilities Act of 1990 (the "Act") (42 U.S.C. 5121 01 et seq.), which prohibits discrimination on the basis of disability by public entities in all services, programs, and activities provided or made available by public entities, and the rules and regulations promulgated pursuant there unto, are made a part of this contract. In providing any aid, benefit, or service on behalf of the owner pursuant to this contract, the contractor agrees that the performance shall be in strict compliance with the Act. In the event that the contractor, its agents, servants, employees, or subcontractors violate or are alleged to have violated the Act during the performance of this contract, the contractor shall defend the owner in any action or administrative proceeding commenced pursuant to this Act. The contractor shall indemnify, protect, and save harmless the owner, its agents, servants, and employees from and against any and all suits, claims, losses, demands, or damages, of whatever kind or nature arising out of or claimed to arise out of the alleged violation. The contractor shall, at its own expense, appear, defend, and pay any and all charges for legal services and any and all costs and other expenses arising from such action or administrative proceeding or incurred in connection therewith. In any and all complaints brought pursuant to the owner's grievance procedure, the contractor agrees to abide by any decision of the owner which is rendered pursuant to said grievance procedure. If any action or administrative proceeding results in an award of damages against the owner, or if the owner incurs any expense to cure a violation of the ADA which has been brought pursuant to its grievance procedure, the contractor shall satisfy and discharge the same at its own expense.

The owner shall, as soon as practicable after a claim has been made against it, give written notice thereof to the contractor along with full and complete particulars of the claim. If any action or administrative proceeding is brought against the owner or any of its agents, servants, and employees, the owner shall expeditiously forward or have forwarded to the contractor every demand, complaint, notice, summons, pleading, or other process received by the owner or its representatives.

It is expressly agreed and understood that any approval by the owner of the services provided by the contractor pursuant to this contract will not relieve the contractor of the obligation to comply with the Act and to defend, indemnify, protect, and save harmless the owner pursuant to this paragraph.

It is further agreed and understood that the owner assumes no obligation to indemnify or save harmless the contractor, its agents, servants, employees and subcontractors for any claim which may arise out of their performance of this Agreement. Furthermore, the contractor expressly understands and agrees that the provisions of this indemnification clause shall in no way limit the contractor's obligations assumed in this Agreement, nor shall they be construed to relieve the contractor from any liability, nor preclude the owner from taking any other actions available to it under any other provisions of the Agreement or otherwise at law.

Representative's Name/Title Print): A. Lawton Langford

Representative's Signature: A. Lawton Langford

Name of Company: municipal code corporation

Tel. No.: 800-262-2033

Date: MM 7/17/2014

**Minority/Woman Business Enterprise (MWBE)
Questionnaire for Bidders**

Jersey City Ordinance C-829 establishes a goal of awarding 20% of the dollar amount of total city procurement to minority and woman owned business enterprises.

To assist us in monitoring our achievement of this goal, please indicate below whether your company is or is not a minority owned and/or woman owned business, and return this form with your bid proposal.

Business Name : Municipal Code Corporation
Address : PO Box 2235 Tallahassee FL 32316
Telephone No. : 850-576-3171 or 800-262-2633
Contact Name : Steffanie Rasmussen, Asst. VP Sales

Please check applicable category :

Minority Owned Business (MBE) Minority & Woman Owned Business (MWBE)
 Woman Owned business (WBE) Neither

Definitions

Minority Business Enterprise

Minority Business Enterprise means a business which is a sole proprietorship, partnership or corporation at least 51% of which is owned and controlled by persons who are African American, Hispanic, Asian American, American Indian or Alaskan native, defined as follows:

African American: a person having origins in any of the black racial groups of Africa

Hispanic: a person of Mexican, Puerto Rican, Central or South American or other non-European Spanish culture or origin regardless of race.

Asian: a person having origins in any of the original peoples of the Far East, South East Asia, Indian subcontinent, Hawaii or the Pacific Islands.

American Indian or Alaskan Native: a person having origins in any of the original peoples of North America and who maintains cultural identification through tribal affiliation or community recognition.

Woman Business Enterprise

Woman Business Enterprise means a business which is a sole proprietorship, partnership or corporation at least 51% of which is owned and controlled by a woman or women.

Sincerely,

Patricia A. Chiacchio

Patricia A. Chiacchio
Director, Division of Revenue

STATE OF NEW JERSEY
BUSINESS REGISTRATION CERTIFICATE
FOR STATE AGENCY AND CASINO SERVICE CONTRACTORS

DEPARTMENT OF TREASURY/
DIVISION OF REVENUE
PO BOX 252
TRENTON, N J 08646-0252

TAXPAYER NAME:

MUNICIPAL CODE CORPORATION

TAXPAYER IDENTIFICATION#

ADDRESS

1700 CAPITAL CIRCLE SW
TALLAHASSEE FL 32310

EFFECTIVE DATE:

09/01/01

FORM-BRC(08-01)

TRADE NAME:

CONTRACTOR CERTIFICATION#

0106069

ISSUANCE DATE:

11/01/01

Patricia A. Chiacchio

Director, Division of Revenue

This Certificate is NOT assignable or transferable. It must be conspicuously displayed at above address.

CONTRACT

This contract dated the _____ day of _____, 2014 between the City of Jersey City, a municipal corporation, with offices at 280 Grove Street, Jersey City, New Jersey 07302 ("City") and Municipal Code Corporation, 1700 Capital Circle SW, P. O. Box 2235, Tallahassee, FL 32316 ("Contractor")

I. Scope of Services

Contractor is hereby retained to:

- A. Perform codification services for City ordinances enacted from August 1, 2014 through July 31, 2016.
- B. The services Contractor will perform are more fully described in the proposal prepared by Contractor dated July 2, 2014 that is attached hereto as Exhibit A and incorporated herein by reference. In event that there is a conflict or discrepancy between the provisions of this Contract and the provisions of Contractor's proposal, the provisions of this Contract shall govern.

II. Consideration

A. For the above services, Contractor will be paid based on the following fee schedule:

- 1. Supplement Service Base Page Rate:
 - a. Single Column (11 Point Times New Roman) \$ 19.60 per page
 - b. Base page rate includes:
 - (1) Acknowledgment of Material
 - (2) Data conversion, as necessary
 - (3) Editorial Work
 - (4) Proofreading
 - (5) Indexing
 - (6) Schedule as selected by Client
 - (7) Updating Internet
 - (8) Providing a PDF of each supplement
- 2. Additional Services that apply to Supplement Service:
 - a. Code on the Internet plus CodeBank (August to July annual fee) \$ 900.00
 - b. Graphics and tabular matter; per graphic or table \$ 10.00
 - c. Freight Actual freight
 - d. New Ordinances on the Web (NOW - August to July annual fee) \$2,000.00
 - e. OrdBank (August to July annual fee) \$1,000.00
 - f. XML Export for integration with

Spatial Data Logic, per delivery \$ 75.00

3. Payment for Supplement and Additional Services
 - a. Invoices to be submitted upon shipment of Project(s)/Supplement(s)
 - b. Payment of invoices to be made via Partial Payment Vouchers
4. Total contract price shall not exceed \$40,000.00.

III. Term

The term of this Contract is two (2) years, commencing on August 1, 2014 and ending on July 31, 2016.

IV. Assignment

The services under this Contract shall be performed exclusively by Contractor. Contractor may assign work under this Contract to another party only with the approval of the City Clerk.

V. Termination of Contract

The City Clerk reserves the right to terminate this Contract at any time for any reason whatsoever. Upon termination, Contractor shall be paid for services due up to the date of termination. Thereafter, this Contract shall be null and void with no further rights or obligations emanating therefrom.

VI. Compliance With Equal Employment Opportunity/Affirmative Action Plan

- A. If the Agreement exceeds \$36,000.00, it shall also be subject to the provisions of N.J.S.A. 10:5-31 et seq. and N.J.A.C. 17:27 et seq. (Equal Employment Opportunity and Affirmative Action provisions).
- B. This Agreement shall not become effective and contractor shall provide no services under this Agreement until it has complied with the Equal Employment Opportunity and Affirmative Action provisions. The Mandatory Equal Employment Opportunity/Affirmative Action Language, Exhibit B summarizes the full, required regulatory text (Exhibit B and additional EEO/AA mandatory languages and forms are attached hereto and incorporated herein).
- C. Contractor shall submit to the public agency, after notification of award but prior to execution of a goods and services contract, one of the following three documents:

1. A photo copy of a valid letter that the contractor is operating under an existing Federally approved or sanctioned affirmative action programs (good for one year from the date of the letter); or
2. A photocopy of a Certificate of Employee Information Report approval, issued in accordance with N.J.A.C. 17:27-4; or
3. A photocopy of an Employee Information Report (Form AA 302) provided by the Division and distributed to the public agency to be completed by the contractor, in accordance with N.J.A.C. 17:27-4.

VII. Compliance with Americans with Disabilities Act of 1990

Discrimination on the basis of disability in contracting for the purchase of goods and services is prohibited. Contractors are required to read Americans with Disabilities language that is included as Appendix A of this specification and agree that the provisions of Title II of the Act are made a part of the contract. The contractor is obligated to comply with the Act and to hold the owner harmless.

VIII. New Jersey Business Registration Requirements

The contractor shall provide written notice to its subcontractors of the responsibility to submit proof of business registration to the contractor.

Before final payment on the contract is made by the contracting agency, the contractor shall submit an accurate list and the proof of business registration of each subcontractor or supplier used in the fulfillment of the contract, or shall attest that no subcontractors were used.

For the term of the contract, the contractor and each of its affiliates and a subcontractor and each of its affiliates (N.J.S.A. 52:32-44(g)(3)) shall collect and remit to the Director, New Jersey Division of Taxation, the use tax due pursuant to the Sales and Use Tax Act on all sales of tangible personal property delivered into this State, regardless of whether the tangible personal property is intended for a contract with a contracting agency.

A business organization that fails to provide a copy of a business registration as required pursuant to section 1 of P.L. 2001, c. 134 (C.52:32-44 et seq.) or subsection e. or f. of section 92 of P.L. 1977, c. 110 (C.5:12-92), or that provides false business registration information under the requirements of either of those sections, shall be liable for a penalty of \$25 for each day of violation, not to exceed \$50,000 for each business registration copy not properly provided under a contract with a contracting agency.

IX. Political Contribution Prohibition

This contract has been awarded to the Contractor based on the merits and abilities of the contractor to provide the goods or services as described herein. This contract was not

awarded through a "fair and open process" pursuant to N.J.S.A. 19:44A-20.4 et seq. As such, the undersigned does hereby attest that the Contractor, its subsidiaries, assigns or principals controlling in excess of 10% of the company have neither made a contribution, that is reportable pursuant to the Election Law Enforcement Commission pursuant to N.J.S.A. 19:44A-8 or 19:44A-16, in the one (1) year period preceding the award of the contract that would, pursuant to P.L. 2004, c.19, affect its eligibility to perform this contract, nor will it make a reportable contribution during the term of the contract to any political party committee in the City of Jersey City if a member of that political party is serving in an elective public office of the City of Jersey City when the contract is awarded, or to any candidate committee of any person serving in an elective public office of the City of Jersey City when the contract is awarded.

X. Chapter 271 Political Contribution Disclosure

Contractor is advised of its responsibility to file an annual disclosure statement on political contributions with the New Jersey Election Law Enforcement Commission (ELEC) pursuant to N.J.S.A. 19:44A-20.13 (P.L. 2005, c.271) if the Contractor receives contracts in excess of \$50,000 from public entities in a calendar year. It is the Contractor's responsibility to determine if filing is necessary. Additional information on this requirement is available from ELEC at 888-313-3532 or at www.elec.state.nj.us.

XI. City of Jersey City Contractor Pay-to-Play Reform Ordinance

This contract was awarded in accordance with the City of Jersey City's Contractor Pay-to-Play Reform Ordinance, Section 3-51.1 of the City Code. As such the undersigned does hereby attest that Contractor, its subsidiaries, assigns or principals have neither made a reportable contribution in the one year period preceding the date that the City Council awards the contract that would be deemed to be a violation of Section 3-51.1, nor

will Contractor, its subsidiaries, assigns or principals make a reportable contribution during the term of the contract that would be in violation of Section 3-51.1.

IN WITNESS WHEREOF, the parties hereto have executed this Contract as of the day and year first written above.

Attest:

CITY OF JERSEY CITY

By: _____
Robert Byrne
City Clerk

By: _____
Robert Kakoleski
Business Administrator

Witness:

MUNICIPAL CODE CORPORATION

By: _____

By: _____

Resolution of the City of Jersey City, N.J.

City Clerk File No. Res. 14.488

Agenda No. 10.U

Approved: JUL 16 2014

TITLE:



A RESOLUTION TO ACCEPT THE PROPOSAL FROM THE RUTGERS CENTER FOR WOMEN AND WORK TO PERFORM AN EVALUATION OF THE ECONOMIC IMPACT OF JERSEY CITY'S EARNED SICK LEAVE ORDINANCE AND AWARD THE RUTGERS CENTER FOR WOMEN AND WORK A CONTRACT TO PERFORM THE EVALUATION

COUNCIL offered and moved adoption of the following resolution:

WHEREAS, the Municipal Council passed Ordinance 13-097 on September 23, 2013 which required that employees in Jersey City be provided earned sick leave by their employers; and

WHEREAS, Ordinance 13-097 took effect on January 24, 2014, 120 days after the passage of Ordinance 13-097; and

WHEREAS, §3-52.7 of the Ordinance 13-097, entitled "Research" provided that the City enter into a contract to have a research study undertaken to measure and evaluate the economic impact on businesses and the impact on the health of residents as a result of this Ordinance; and

WHEREAS, §3-52.7 further provided that the this study shall begin one year from the effective date of Ordinance 13-097, and that the City shall engage the services of a competent research institution to conduct this study; and

WHEREAS, Rutgers University is a state school which includes the Center for Woman and Work; and

WHEREAS, the Rutgers Center for Women and Work has submitted a proposal to conduct this a study and a copy of this the proposal is attached hereto as Exhibit A; and

WHEREAS, pursuant to N.J.S.A. 40A:11-5(2), any contract may be negotiated and awarded by the Municipal Council without public advertising for bids and can be awarded by resolution of the Municipal Council so long as it is to be made or entered into with the United States of America, the State of New Jersey, or any board, body, officer, agency or authority thereof or any other state or subdivision thereof; and

WHEREAS, the Rutgers Center for Women and Work is a department within Rutgers, the State University of New Jersey, and therefore fits the exception to public bidding found in N.J.S.A. 40A:11-5(2); and

WHEREAS, the proposal submitted by the Rutgers Center for Women and Work stipulates that the entire scope of the proposal will cost \$41,000; and

WHEREAS, the Rutgers Center for Women and Work requests \$20,000 from the City to perform this study; and

WHEREAS, there are sufficient funds in Account Number 14-01-201-27-331-314 to pay for this study.

NOW, THEREFORE, BE IT RESOLVED by the Municipal Council of the City of Jersey City that:

TITLE:

A RESOLUTION TO ACCEPT THE PROPOSAL FROM THE RUTGERS CENTER FOR WOMEN AND WORK TO PERFORM AN EVALUATION OF THE ECONOMIC IMPACT OF JERSEY CITY'S EARNED SICK LEAVE ORDINANCE AND AWARD THE RUTGERS CENTER FOR WOMEN AND WORK A CONTRACT TO PERFORM THE EVALUATION

The City accept the proposal of the Rutgers Center for Women and Work to perform the research study mandated by §3-52.7 of Ordinance 13-097 to measure and evaluate the economic impact on businesses and the impact on the health of residents as a result of Jersey City's Earned Sick Leave Ordinance, and award the Rutgers Center for Women and Work a contract to perform this study (attached as Exhibit B) pursuant to and in accordance with the terms and conditions of the proposal attached hereto.

1. A contract in the amount of \$20,000.00 is awarded to NJIT to perform a needs assessment and strategic plan study for the management of public records; and
2. The term of the contract shall be six months commencing on November 1, 2014 and expiring on April 30, 2015; and
3. Subject to such modifications as deemed necessary or appropriate by Corporation Counsel, the Mayor or Business Administrator is authorized to execute an agreement in substantially in the form of the attached; and
4. The award of this contract shall be subject to the condition that the contractor provides satisfactory evidence of the compliance with the Affirmative Action Amendments to the Law Against Discrimination, N.J.S.A. 10:5-31, et seq.

I , Donna Mauer, as Chief Financial Officer, hereby certify that funds are available in Account No. 14-01-201-27-331-314. PO#114177

JJH
7/7/14

APPROVED: 

APPROVED AS TO LEGAL FORM

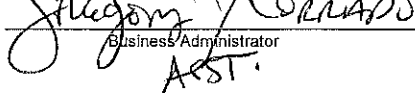
APPROVED: 
Business Administrator
ARST

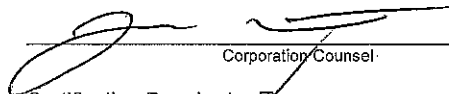
Corporation Counsel
Certification Required

Not Required

APPROVED 8-1

RECORD OF COUNCIL VOTE ON FINAL PASSAGE 7.16.14											
COUNCILPERSON	AYE	NAY	N.V.	COUNCILPERSON	AYE	NAY	N.V.	COUNCILPERSON	AYE	NAY	N.V.
GAJEWSKI	✓			YUN		✓		RIVERA	✓		
RAMCHAL	✓			OSBORNE	✓			WATTERMAN	✓		
BOGGIANO	✓			COLEMAN	✓			LAVARRO, PRES.	✓		

✓ Indicates Vote

N.V.-Not Voting (Abstain)

Adopted at a meeting of the Municipal Council of the City of Jersey City N.J.

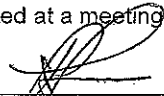
Rolando R. Lavarro, Jr., President of Council

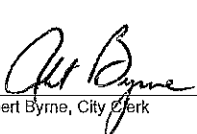
Robert Byrne, City Clerk

RESOLUTION FACT SHEET - CONTRACT AWARD

This summary sheet is to be attached to the front of any resolution that is submitted for Council consideration. Incomplete or vague fact sheets will be returned with the resolution.

Full Title of Ordinance/Resolution

A RESOLUTION TO ACCEPT THE PROPOSAL FROM THE RUTGERS CENTER FOR WOMEN AND WORK TO PERFORM AN EVALUATION OF THE ECONOMIC IMPACT OF JERSEY CITY'S EARNED SICK LEAVE ORDINANCE AND AWARD THE RUTGERS CENTER FOR WOMEN AND WORK A CONTRACT TO PERFORM THE EVALUATION

Project Manager

Department/Division	HHS	Director's Office
Name/Title	Stacey L Flanagan	Director
Phone/email	201-547-6560	sflanagan@jcnj.org

Note: Project Manager must be available by phone during agenda meeting (Wednesday prior to council meeting @ 4:00 p.m.)

Contract Purpose

On September 23, 2013, Municipal Council passed Ordinance 13-097, which required that employees in Jersey City be provided earned sick leave by their employers. As part of this ordinance, The City of Jersey City is required to research the impact of this ordinance on the community. This Ordinance will allow the City of Jersey City's Department of Health & Human Services to enter into a contract to have a research study, undertaken by the Rutgers Center for Women and Work, to measure and evaluate the economic impact on businesses and the impact on the health of residents as a result of this Ordinance.

Cost (Identify all sources and amounts)

City Funds, 2014 Budget Allocation

Contract term (include all proposed renewals)

The term of the contract is six-months, commencing November 1, 2014 and expiring on April 30, 2015.

Type of award

If "Other Exception", enter type

Additional Information

I certify that all the facts presented herein are accurate.

Signature of Department Director



Date

EXHIBIT A

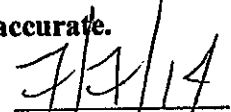

Center for Women and Work

School of Management and Labor Relations
Rutgers, The State University of New Jersey
Labor Education Building
50 Labor Center Way
New Brunswick, NJ 08901

Website www.cww.rutgers.edu
www.nitimetocare.rutgers.edu
email: kswwhite@work.rutgers.edu
Phone 848-932-4614
Fax 732-932-1254

June 24, 2014

Robert Sommer
Senior Advisor to Mayor Fulop
City Hall - 280 Grove Street
Jersey City, New Jersey 07302

Dear Bob,

The Rutgers Center for Women and Work (CWW) is pleased to submit the attached proposal to conduct an evaluation of the economic impact of Jersey City's earned sick days ordinance. Specifically, CWW requests a grant of \$20,000 from Jersey City to cover approximately one-half of the total costs to conduct surveys of Jersey City employers and employees in diverse industries and firm sizes to address the economic impact of Jersey City's earned sick days ordinance.

Please let us know if you have any questions or need more information. As soon as we receive approval from you for the funding, we'll begin drafting the survey questions and identifying additional sources to fund the balance of the work.

Best,

Karen White
Director, Working Families Program

Attachment (1)



Center for Women and Work

School of Management and Labor Relations
Rutgers, The State University of New Jersey
Labor Education Building
50 Labor Center Way
New Brunswick, NJ 08901

Website www.cww.rutgers.edu
www.njtimetocare.rutgers.edu
email: kswwhite@work.rutgers.edu
Phone 848-932-4614
Fax 732-932-1254

***Research Proposal: Assessment of
Jersey City Ordinance Concerning Earned Sick Days***

OVERVIEW:

On September 25, 2013, the Jersey City Council adopted an ordinance (13.097) to provide workers with a minimum number of earned sick days to recover from their own illnesses or to care for sick family members. The ordinance went into effect on January 24, 2014 and includes a provision for a research study, to be conducted one year after implementation, on the economic impact on businesses and the impact on the health of residents as a result of the ordinance.

The Rutgers Center for Women and Work (CWW) proposes to conduct such an evaluation measuring the impact of earned sick days on businesses and workers in Jersey City. The evaluation will assess the economic effects of the law and answer important questions about the law's effectiveness in reaching its stated purposes and goals. CWW is uniquely qualified to perform this research. We have a proven track record of conducting rigorous research, evaluation, outreach and education to inform public discourse, and strengthen families, communities, and societies. We have the research infrastructure and expertise to conduct large scale quantitative studies of workforce policy implementation and recently completed an analysis of data collected from a sample of New Jersey residents on the need for and usage of policies mandating paid family leave. We also have subject matter expertise in the areas of policy, work/family balance, and gender and work.

BACKGROUND:

According to the most recent data, over 1.2 million workers, or 38 percent of New Jersey's private sector workforce, lack access to any earned sick days.¹ These figures are more striking when disaggregated by occupation. For example, only 13 percent of workers in management occupations in New Jersey lack paid sick days. However, in service sector jobs such as food preparation and service, 76 percent of New Jersey workers do not have paid sick days. The overwhelming majority of workers in child care centers, retail and nursing homes also lack access to paid sick days.

RUTGERS

Center for Women and Work

Though employers bear the cost of providing this benefit, research shows that providing earned sick days brings a range of economic, social and health benefits for workers, businesses, and communities. Studies have demonstrated that providing earned sick days can benefit workers by increasing economic and job security, promoting good health, and allowing workers to care for their own illnesses or sick family members. Research also shows that employers benefit from reduced turnover, increased productivity and employee retention, and reduced workplace contagion.ⁱⁱ Workers with paid sick days are more productive and are more attached to employers.ⁱⁱⁱ Communities also benefit from decreased contagion and lower health care costs.

As of June 2014, seven U.S. cities, including Jersey City, and one state have established laws to guarantee workers the right to earn paid sick days from their employers. They are: San Francisco, CA; Portland, OR; Seattle, WA; New York, NY; Washington, DC; and Connecticut. Jersey City was the sixth U.S. city, and first jurisdiction in New Jersey, to have an earned sick days law. Newark, New Jersey was the seventh city and second in the state to pass an earned sick days ordinance.

PROPOSED RESEARCH:

In order to be most efficient and effective in accomplishing this research, the Rutgers Center for Women and Work (CWW) will partner with the Rutgers' Eagleton Center for Public Interest Polling (ECPIP) to conduct cross-sectional phone surveys of Jersey City employers and employees in diverse industries and firm sizes to assess the economic and health impact of Jersey City's earned sick days ordinance.

Survey of Jersey City Employers. A survey of Jersey City businesses selected from Dun & Bradstreet will provide valuable information about their experiences in complying with the provisions of the earned sick days ordinance. In addition to providing detailed information regarding type of business and business characteristics, employee demographics, wages and benefits, the research will seek to answer questions about employers' knowledge of the law, and the impact of the ordinance on productivity, profitability, turnover and absences. Possible areas of inquiry include: businesses' awareness and implementation of the law; compliance with various aspects of the law; changes to policies, if any (including implementation of new policies, or changes to existing policies); effect of the ordinance on costs; and changes in staffing patterns.

Survey of Employees. In addition to an employer survey, a random digit dial survey of employees will provide important information about the impact of the ordinance on workers and their families' health and economic well-being, as well as employers' compliance with its requirements. In addition to documenting employee demographics (age, gender, race and ethnicity, marital status, educational background, health insurance coverage, chronic

RUTGERS

Center for Women and Work

conditions, caretaking responsibilities), research will seek to answer questions about eligibility for and use of earned sick days (both paid and unpaid; for self, child, parent or other family member); awareness of the law; changes in health outcomes; work/life balance; wages and benefits; number of sick days used, and performance (including presenteeism, morale, stress).

TIMELINE:

We anticipate it will take approximately six months to complete this work, as outlined below.

January 2014	Ordinance Implementation
November, 2014 – January 2015	Develop and Field Test Surveys
February 2015	Survey Employers & Employees
March 2015	Analyze Data & draft report of findings
April 2015	Final Draft Report of Findings & Recommendations

BUDGET:

We estimate the cost of conducting this research at \$41,000. Costs include:

Rutgers ECPIP – 10 Question Survey of 300 Employers	\$18,000
Rutgers ECPIP – 10 Question Survey of 200 Employees	\$11,000
CWW Staff time to develop questions, analyze data & draft report	\$12,000
	<hr/>
TOTAL	\$41,000

While the total project budget is \$41,000, we are only requesting \$20,000 from Jersey City. We are confident that we will be able to secure the remaining funds from foundations and other interested organizations and will work to identify and secure the additional \$21,000 during coming months. Two possibilities are the Fund for New Jersey and The Ford Foundation, both of which have funded CWW on similar research in the past.

ABOUT THE CENTER:

The Center for Women and Work at Rutgers, the State University of New Jersey is uniquely qualified to conduct this research. Founded in 1993, CWW is housed in the School of Management and Labor Relations and engages in issues that directly affect the living standards of New Jersey's working families. CWW is an innovative leader in research and programs that

promote gender equity, a high-skill economy, and reconciliation of work and well-being for all.

Examples of our research include:

- Research Reports: Policy in Action: New Jersey's Family Leave Insurance Program at Age Three, January 2013; Policy Matters: Public Policy, Paid Leave for New Parents, and Economic Security for U.S. Workers, April 2012; , Leaves That Pay: Employer and Worker Experiences with Paid Family Leave in California , 2011; and A Health Impact Assessment of Paid Sick Days Policy in New Jersey, April 2011
- Issue Brief: Awareness of New Jersey's Family Leave Insurance Program Is Low, Even As Public Support Remains High and Need Persists, October 2012
- Fact Sheet: A Higher Minimum Wage Would Benefit Working Women, Their Families and All New Jerseyans (UPDATED - fact sheet), October 2012

ⁱ Health Impact Partners (April 2011). A Health Impact Assessment of Paid Sick Days Policies in New Jersey.

ⁱⁱ Lovell, V. (2005, March). Valuing Good Health: An Estimate of Costs and Savings for the Healthy Families Act. Institute for Women's Policy Research.

ⁱⁱⁱ Miller, Kevin and Claudia Williams. 2012. Valuing Good Health in Massachusetts: The Costs and Benefits of Paid Sick Days. Institute for Women's Policy Research.

<http://www.iwpr.org/publications/pubs/valuing-good-health-in-massachusetts-the-costs-and-benefits-of-paid-sick-days-2>

EXHIBIT B

CONTRACT

This agreement entered into by and between **The City of Jersey City**, a municipal corporation of the State of New Jersey, having its principal offices at City Hall, 280 Grove Street, Jersey City, New Jersey 07302 (hereinafter referred to as the "**CITY**"), and **Rutgers University, Center for Women and Work**, located at 50 Labor Center Way, New Brunswick, New Jersey 08903 (hereinafter referred to as the "**VENDOR**").

NOW THEREFORE, the parties hereto do mutually agree as follows:

1. **CONTRACT WITH VENDOR:** The **CITY** hereby agrees to engage the **VENDOR** and the **VENDOR** hereby agrees to provide the Services on the basis hereinafter set forth in conformity with all applicable federal, state and local laws and regulations to which the **CITY**, the **VENDOR**, and their respective employees are subject.

2. **SCOPE OF SERVICES:** Perform a study to measure and evaluate the economic impact on businesses and the impact on the health of residents as a result of Ordinance 13-097, better known as Jersey City's Earned Sick Leave Ordinance.
VENDOR shall complete all Work as specified or indicated in the proposal ("Proposal") submitted by VENDOR, attached hereto and incorporated by reference herein. The work as specified In the Proposal shall be collectively known as the "Services". To the extent that any of the Services provided by VENDOR are advisory, no specific result is assured or guaranteed. VENDOR expressly disclaims all other representations or warranties, whether express or implied, or statutory to the extent permitted by law. There are no representations, warranties or promises not expressly set forth in this Agreement.

3. **DATA TO BE FURNISHED TO VENDOR:** The **CITY** shall provide the **VENDOR** with such access to its records, files and personnel, as may be reasonably necessary for the performance of the Services.

4. **AMOUNT AND TERM OF CONTRACT:** The maximum amount of this contract shall not exceed **\$20,000** inclusive of all actual disbursements. The contract term shall be six (6) months effective as of November 1, 2014 and ending on April 30, 2015.

5. **PAYMENT SCHEDULE AND SERVICES:** In consideration for the above services, the **CITY** shall pay the **VENDOR** monthly for services.

Itemized invoices for service rendered shall be submitted and shall include disbursements, costs and expenses accrued in connection with this matter. Payments are to be made no later than thirty (30) days after submission of invoices by **VENDOR**.

No retainage is required under this contract.

The services under this agreement shall be performed in the most efficient and economic manner. Should additional services be required, the contract shall be amended with the approval by the Municipal Council.

All taxes and governmental imposition upon the Services, including labor and materials, furnished hereunder shall be paid by **VENDOR**. The **CITY** shall not be obligated to compensate **VENDOR** for any Services performed prior to the commencement of this contract or after its expiration.

Payments hereunder shall only be made upon invoices properly submitted hereunder. Invoices shall be submitted monthly for services performed or costs incurred during the preceding month. Each invoice submitted shall identify the funding authorization (purchase order) number assigned to this contract. Each invoice shall be supported by satisfactory documentation as to the time expended and the service performed during that time.

Payment will be made within thirty (30) days following approval of each invoice. Such approval or payment shall not constitute acceptance or approval of the service invoiced. Final payment shall be made only upon satisfactory completion of the entire service and submittal of all necessary and appropriate documentation required.

6. **LIMITATION OF COSTS:** The parties agree that the service shall not cost the **CITY** more than the amount specified in Paragraph 4 above. However, the parties acknowledge that the amount specified in Paragraph 4 above is an estimate of the amount required to complete the contract agreement. When the amounts incurred by **VENDOR** reach seventy-five percent (75%) of the authorized amount, **VENDOR** shall notify the **CITY** in writing. The parties shall review the status of the service and determine the appropriate course of action to either increase the amounts available, resolve the matters with the amount specified, or to terminate the **VENDOR**'s engagement.

7. **INDEMNIFICATION AND INSURANCE:** Each party shall at all times defend, indemnify and hold the other harmless, from and against any and all third party claims, damages, liabilities, costs and expenses, whether in contract or tort, arising out of personal injury, including death, or property damage, caused by the negligent and/or intentional act or omission while performing its obligations under this Agreement. This indemnification obligation is contingent upon the Indemnified Party providing the Indemnifying Party with prompt written notice of such claim, information, all reasonable assistance in the defense

of such action, and sole authority to defend or settle such claim. The parties maximum liability for any action arising under this Agreement, regardless of the form of action and whether in tort or contract, shall be limited to the amount paid by CITY to VENDOR for the Services from which the claim arose.

8. **CHANGES AND TERMINATION:** Any changes in the service, compensation or other terms of this Agreement shall be made by written amendment to this Agreement, signed by the parties hereto. The performance of the service hereunder may be terminated by the CITY in whole or in part by written notice to VENDOR as determined by the contract provisions in Paragraph 17 (Termination).

9. **OWNERSHIP OF INFORMATION AND DATA:** All CITY information or CITY data utilized hereunder by VENDOR for purposes of performing the Services shall remain the property of the CITY, and VENDOR shall not use such information or data except for the performance of the service hereunder, without the prior written permission of the CITY.

10. **CONFLICT OF INTEREST:** VENDOR agrees that it will not knowingly or intentionally accept any assignments, compensation, consideration or gratuities from any other party with an interest in the subject matter of this contract that shall conflict or shall have the appearance of conflicting with the interest of the CITY relative to the purposes of this agreement.

In the event that a conflict or potential conflict of interest arise, VENDOR shall notify the CITY in writing within three (3) days of becoming aware of the conflict or the potential conflict. Failure to provide such notice may be grounds for termination of this agreement for cause.

In the event that the CITY receives timely notice of an actual or potential conflict, VENDOR and the CITY shall attempt to reach an agreement on a course of action in response to the actual or potential conflict. If such an agreement cannot be reached, the CITY has the right to terminate the contract for convenience. Termination of this contract shall not affect the rights and obligations of the parties accrued prior to termination. In the event of termination of the contract by the CITY, VENDOR will be paid for its costs and expenses incurred or committed to be expended as of the effective date of termination as determined by the contract provisions in Paragraph 17 (Termination).

11. **LIMITATION OF LIABILITY:** Subject to the limitations imposed in Paragraph 7 (Indemnification and Insurance), neither party shall be liable for any incidental, indirect, consequential, or punitive damages, under any circumstances.

12. **ASSIGNMENT:** VENDOR shall not assign, transfer, convey, sublet, or otherwise dispose of this contract or its right, title or interest in or to the same or any part thereof without prior written consent of the CITY endorsed thereon or attached thereto.

13. **SOCIAL SECURITY ACT:** **VENDOR** shall be and remain an independent contractor with respect to all services performed hereunder and agrees to and does hereby accept full and exclusive liability for the payment of any and all contributions or taxes for social security, unemployment insurance or old age retirement benefits, pensions or annuities now or hereafter imposed under any state or federal law which are measured by the wages, salaries or other remuneration paid to persons employed by **VENDOR** for work performed under the terms of this contract and further agrees to obey all lawful rules and regulations and to meet all lawful requirements which are now or hereafter may be issued or promulgated under said respective laws by all duly authorized state or federal officials, and **VENDOR** agrees to indemnify and save harmless the **CITY** from any such contributions or taxes or liability therefor.
14. **INTEGRATED AGREEMENT:** This Agreement, including the attachments referenced herein, constitutes the entire agreement of the parties. No prior agreements or understandings or oral modifications or representations are enforceable unless reduced to written form, signed by both parties, and are incorporated herein by amendment prior to performance of the affected Service.
15. **GOVERNING LAW:** This Agreement shall be governed by and interpreted pursuant to the law of the United States and the State of New Jersey, as appropriate, notwithstanding any provisions of such laws relating to jurisdiction.
16. **NO ADVANCE PAYMENT:** No payments may be made in advance of services pursuant to N.J.S.A. 40A:5-16.
17. **TERMINATION:** Either party shall have the right to terminate this Contract at its convenience without cause at any time by giving written notice to the other party of such termination and specifying the effective date thereof at least thirty (30) days before the effective date of such termination. Termination of this contract shall not affect the rights and obligations of the parties accrued prior to termination. In the event of termination by the **CITY** as provided herein, **VENDOR** shall receive full compensation for any services rendered, or any disbursements, costs or expenses incurred or committed to be expended under this Contract up to the date set forth in written notice of said termination. **VENDOR's** work product shall be submitted to the **CITY** upon demand at the termination of the Contract.
18. **WAIVER AND AMENDMENTS:** Any provisions of the Contract for services may be waived or amended upon agreement in writing signed by the parties hereto, subject to approval by the **CITY's** Municipal Council.

19. **COUNTERPARTS:** This Contract shall be executed in four (4) counterparts, each of which shall be deemed to be an original and such counterparts shall constitute one and the same document.

IN WITNESS WHEREOF, the City and **VENDOR** have executed this Contract as of this date first herein written.

Witness

**Rutgers University
Center for Women and Work**

Dana Britton,
Director

Attest

City of Jersey City

Robert Byrne
City Clerk

Robert J. Kakoleski,
Business Administrator

Resolution of the City of Jersey City, N.J.

City Clerk File No. Res. 14.489

Agenda No. 10.V

Approved: JUL 16 2014

TITLE:



RESOLUTION AUTHORIZING THE AWARD OF A CONTRACT TO NEW YORK STATE TECHNOLOGY ENTERPRISE CORPORATION (NYSTEC) FOR THE ASSESSMENT OF THE PUBLIC SAFETY NETWORK AND COMMUNICATIONS SYSTEM FOR THE DEPARTMENT OF PUBLIC SAFETY (FIRE HEADQUARTERS)

COUNCIL OFFERED AND MOVED ADOPTION OF THE FOLLOWING RESOLUTION:

WHEREAS, and in conformity with N.J.S.A. 40A:11-6.1(a) quotes were solicited for the **Assessment of the Public Safety Network and Communications System**; and

WHEREAS, as per N.J.S.A. 40A:11-6.1(a) four (4) quotes were solicited with the lowest, responsive and responsible being that from New York State Technology Enterprise Corporation (NYSTEC), 500 Avery Lane, Suite A, Rome, New York 13441 in the total amount of **Twenty Four Thousand, Nine Hundred Forty Three Dollars (\$24,943.00)**; and

WHEREAS, the Purchasing Director has certified that he considers said proposal to be fair and reasonable; and

WHEREAS, the City is acquiring these services directly and openly as a statutorily permitted contract pursuant to the provisions of N.J.S.A. 19:44A-20.4 et seq. (Pay-to-Play Law); and

WHEREAS, the Director of the Department of Public Safety (Fire) has determined and certified in writing that the value of the contract will exceed \$17,500.00; and

WHEREAS, the contractor has completed and submitted a Business Entity Disclosure Certification which certifies that the contractor has not made any reportable contributions to the political candidate committees listed in the Business Entity Disclosure Certification in the previous one year, and that the contract will prohibit the contractor from making any reportable contributions during the term of the contract; and

WHEREAS, the contractor has submitted a Chapter 271 Political Contribution Disclosure Certification at least 10 days prior to the award of this contract; and

WHEREAS, the contractor has submitted its Certification of Compliance with the City's Contractor Pay-to-Play Reform Ordinance 08-128 adopted on September 3, 2008; and

WHEREAS, funds in the amount of \$24,943.00 are available in the **Operating Fund Account**.

Account	PO #	Amount
01-201-25-265-405	113907	\$24,943.00

(Continue on page 2)

TITLE:

RESOLUTION AUTHORIZING THE AWARD OF A CONTRACT TO NEW YORK STATE TECHNOLOGY ENTERPRISE CORPORATION (NYSTEC) FOR THE ASSESSMENT OF THE PUBLIC SAFETY NETWORK AND COMMUNICATIONS SYSTEM FOR THE DEPARTMENT OF PUBLIC SAFETY (FIRE HEADQUARTERS)

NOW, THEREFORE BE IT RESOLVED, by the Municipal Council of the City of Jersey City that:

1. A contract in the amount of \$24,943.00 for the **Assessment of the Public Safety Network and Communications System** and the Purchasing Agent is directed to have such a contract drawn up and executed;
2. Upon certification by an official or employee of the City authorized to administer the contract met, payment to the contractor shall be made in accordance with the Local Fiscal Affairs Law, N.J.S.A. 40A:5-1 et seq.; and
3. The Business Entity Disclosure Certification, Chapter 271 Political Contribution Disclosure Certification, the Certification of Compliance with the City's Contractor Pay-to-Play Reform Ordinance, and the Determination of Value Certification, attached hereto and incorporated herein by reference, shall be placed on file with this resolution.

I Donna Mauer, Donna Mauer Chief Financial Officer, hereby certify that funds in the amount of \$24,943.00 are available in **Operating Fund Account**.

Account	PO #	Amount
01-201-25-265-405	113907	\$24,943.00

Peter Folgado
Director of Purchasing, QPA, RPPO

Donna Mauer
Donna Mauer,
Chief Financial Officer

PF/pv
6/17/14

APPROVED: [Signature]

APPROVED AS TO LEGAL FORM

APPROVED: [Signature]
Business Administrator
ASST.

[Signature]
Corporation Counsel

Certification Required

Not Required

APPROVED 9-0

RECORD OF COUNCIL VOTE ON FINAL PASSAGE 7.16.14											
COUNCILPERSON	AYE	NAY	N.V.	COUNCILPERSON	AYE	NAY	N.V.	COUNCILPERSON	AYE	NAY	N.V.
GAJEWSKI	✓			YUN	✓			RIVERA	✓		
RAMCHAL	✓			OSBORNE	✓			WATTERMAN	✓		
BOGGIANO	✓			COLEMAN	✓			LAVARRO, PRES.	✓		

✓ Indicates Vote

N.V.-Not Voting (Abstain)

Adopted at a meeting of the Municipal Council of the City of Jersey City N.J.

[Signature]
Rolando R. Lavarro, Jr., President of Council

[Signature]
Robert Byrne, City Clerk

RESOLUTION FACT SHEET – NON-CONTRACTUAL

This summary sheet is to be attached to the front of any resolution that is submitted for Council consideration. Incomplete or vague fact sheets will be returned with the resolution.

Full Title of Ordinance/Resolution

RESOLUTION AUTHORIZING THE AWARD OF A CONTRACT TO NEW YORK STATE TECHNOLOGY ENTERPRISE CORPORATION (NYSTEC) FOR THE ASSESSMENT OF THE PUBLIC SAFETY NETWORK AND COMMUNICATIONS SYSTEMS FOR THE DEPARTMENT OF PUBLIC SAFETY (FIRE HEADQUARTERS)

Initiator

Department/Division	Department of Public Safety	Division of Fire
Name/Title	James R. Shea	Director
Phone/email	845-772-2426	jshea@njcps.org

Note: Initiator must be available by phone during agenda meeting (Wednesday prior to council meeting @ 4:00 p.m.)

Resolution Purpose

NYSTEC will provide the following assessments for the Bishop Street communication center:

- MPLS vs EVPL vs Private Fiber. Current network will be unsupported in one year.
- Assess present needs for Network Bandwidth connections (LAN/WAN)
- Assess contracts
- Assess technical support staff
- Perform a complete review of its listed systems, create a technology replacement schedule and determine technology direction and recommendations for the communications center.

I certify that all the facts presented herein are accurate.

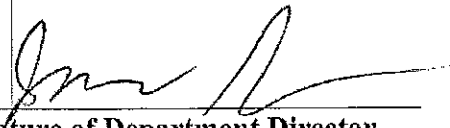

Signature of Department Director

6/18/14
Date

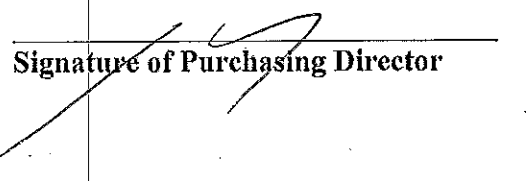

Signature of Purchasing Director

6/18/14
Date

DETERMINATION OF VALUE CERTIFICATION

James R. Shea, of full age, hereby certifies as follows:

1. I am the Director of the City of Jersey City (City) Department of Public Safety/ Division of Fire and have knowledge of the goods and services that the Division of Fire and Emergency Service's needs.
2. The Department of Public Safety requires an assessment of the communication system located at 75 Bishop Street.
3. The City has determined that a contract for the assessment of the Public Safety network and communications systems should be awarded pursuant to N.J.S.A. 19:44A-20.4 et seq (Pay-to-Play Law).
4. **New York State Technology Enterprise Corporation (NYSTEC)** will perform a complete review of the current network systems, create a technology replacement schedule and determine technology direction and recommendations for the communications center at Bishop Street. **NYSTEC** has submitted a proposal indicating that it will provide the services for the sum of \$24,943.
5. The Department of Public Safety/Division of Fire's recommendation is to award the contract to **New York State Technology Enterprise Corporation (NYSTEC)**.
6. The estimated amount of the contract exceeds \$17,500.00 (\$24,943).
7. This certification is made pursuant to N.J.S.A. 19:44A-20.5.
8. I certify that the foregoing statements are true. I am aware that if any of the foregoing statements made by me are willfully false, I am subject to punishment.

Dated: 6/18/14

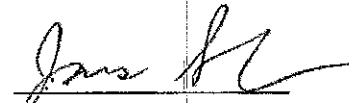
James R. Shea, Director
Department of Public Safety

**CERTIFICATION OF COMPLIANCE WITH THE CITY OF JERSEY CITY
CONTRACTOR PAY-TO-PLAY REFORM ORDINANCE 08-128 ADOPTED
ON SEPTEMBER 3, 2008**

PART I - Vendor Affirmation

The undersigned, being authorized and knowledgeable of the circumstances, does hereby certify that New York State Technology Enterprise Corporation (name of business entity) has not made any reportable contributions in the **one-year period preceding 6/23/2014 (date City Council awards contract) that would be deemed to be violations of Section One of the City of Jersey City's Contractor Pay-to-Play Reform Ordinance 08-128 (attached hereto) and that would bar the award of this contract. I further certify that during the term of the contract NYS TEC (name of business entity) will not make any reportable contributions in violation of Ordinance 08-128.

PART II - Signature and Attestation:

The undersigned is fully aware that if I have misrepresented in whole or part this affirmation and certification, I and/or the business entity, will be liable for any penalty permitted under law.

Name of Business Entity: New York State Technology Enterprise Corporation

Signed J. Behr Title: General Counsel & CEO

Print Name JANA S. BEHR Date: 6/23/2014

Subscribed and sworn before me
this 23 day of June, 2014
My Commission expires:

Carol A. Philippe
(Affiant)

(Print name & title of affiant) (Corporate Seal)

CAROL A. PHILIPPI
NOTARY PUBLIC-STATE OF NEW YORK
No. 01PH6254432
Qualified in Albany County
My Commission Expires January 17, 2016

**Pursuant to Section 2 of Ordinance 08-128, no contributions or solicitation of contributions made prior to the effective date Ordinance 08-128 (September 23, 2008) shall be deemed to be a violation of the Ordinance.

BUSINESS ENTITY DISCLOSURE CERTIFICATION
 FOR NON-FAIR AND OPEN CONTRACTS
 Required Pursuant To N.J.S.A. 19:44A-20.8
 CITY OF JERSEY CITY

Part I – Vendor Affirmation

The undersigned, being authorized and knowledgeable of the circumstances, does hereby certify that the <name of business entity> has not made and will not make any reportable contributions pursuant to N.J.S.A. 19:44A-1 et seq. that, pursuant to P.L. 2004, c. 19 would bar the award of this contract in the one year period preceding (date of award scheduled for approval of the contract by the governing body) to any of the following named candidate committee, joint candidates committee; or political party committee representing the elected officials of the <name of entity of elected officials> as defined pursuant to N.J.S.A. 19:44A-3(p), (q) and (r).

Election Fund for Steven Fulop (2013)	Frank Gajewski for Council
Team Fulop	Friends of Khemraj "Chico" Ramchal
Team Fulop Runoff	Councilperson Richard Boggiano
Lavarro for Council	Michael Yun for Council
Councilperson Joyce E. Watterman	Councilperson Candice Osborne
Councilperson Daniel Rivera	Diane Coleman for Council

Part II – Ownership Disclosure Certification

I certify that the list below contains the names and home addresses of all owners holding 10% or more of the issued and outstanding stock of the undersigned.

Check the box that represents the type of business entity: Other – 501(c)(3) NFP

- Partnership Corporation Sole Proprietorship Subchapter S Corporation
 Limited Partnership Limited Liability Corporation Limited Liability Partnership

Name of Stock or Shareholder	Home Address
No owners - We are a 501(c)(3) Not For Profit Corporation	
Our Board of Directors are listed below	
Michael Walsh (CEO - Bd Member)	
Bill Pirillo - Board Member	
Dr. Thomas Triscavi	
Lisa Marrello	
Dr. Donald Hanson	
Scott Mc Cartney	

Part 3 – Signature and Attestation:

The undersigned is fully aware that if I have misrepresented in whole or part this affirmation and certification, I and/or the business entity, will be liable for any penalty permitted under law.

Name of Business Entity: _____

Signed: JANA S Bohe

Title: General Counsel (CEO)

Print Name: JANA S Bohe

Date: 6/23/2014

Subscribed and sworn before me this 23 day of June, 2014

Carol A Philippi
(Affiant)

My Commission expires:

CAROL A PHILIPPI
 NOTARY PUBLIC-STATE OF NEW YORK
 No. 01PH6254432
 Qualified in Albany County 16
 My Commission Expires January 17, 2016

(Print name & title of affiant) (Corporate Seal)

C. 271 POLITICAL CONTRIBUTION DISCLOSURE FORM

Required Pursuant To N.J.S.A. 19:44A-20.26

This form or its permitted facsimile must be submitted to the local unit no later than 10 days prior to the award of the contract.

Part I - Vendor Information

Vendor Name:	New York State Technology Enterprise Corporation		
Address:	500 Aveny Lane - Suite A		
City:	Rome	State:	NY
		Zip:	13441

The undersigned being authorized to certify, hereby certifies that the submission provided herein represents compliance with the provisions of N.J.S.A. 19:44A-20.26 and as represented by the Instructions accompanying this form.

J. Behr
JANA S. BEHE
6/23/2014

Signature
Printed Name
Title

Part II - Contribution Disclosure

Disclosure requirement: Pursuant to N.J.S.A. 19:44A-20.26 this disclosure must include all reportable political contributions (more than \$300 per election cycle) over the 12 months prior to submission to the committees of the government entities listed on the form provided by the local unit.

Check here if disclosure is provided in electronic form.

Contributor Name	Recipient Name	Date	Dollar Amount
No contributions			\$ 0

Check here if the information is continued on subsequent page(s)

APPENDIX A
AMERICANS WITH DISABILITIES ACT OF 1990
Equal Opportunity for Individuals with Disability

The contractor and the New York State Technology Enterprise Corporation (hereafter "owner") do hereby agree that the provisions of Title 11 of the Americans With Disabilities Act of 1990 (the "Act") (42 USC 5121 01 et seq.), which prohibits discrimination on the basis of disability by public entities in all services, programs, and activities provided or made available by public entities, and the rules and regulations promulgated pursuant there unto, are made a part of this contract. In providing any aid, benefit, or service on behalf of the owner pursuant to this contract, the contractor agrees that the performance shall be in strict compliance with the Act. In the event that the contractor, its agents, servants, employees, or subcontractors violate or are alleged to have violated the Act during the performance of this contract, the contractor shall defend the owner in any action or administrative proceeding commenced pursuant to this Act. The contractor shall indemnify, protect, and save harmless the owner, its agents, servants, and employees from and against any and all suits, claims, losses, demands, or damages, of whatever kind or nature arising out of or claimed to arise out of the alleged violation. The contractor shall, at its own expense, appear, defend, and pay any and all charges for legal services and any and all costs and other expenses arising from such action or administrative proceeding or incurred in connection therewith. In any and all complaints brought pursuant to the owner's grievance procedure, the contractor agrees to abide by any decision of the owner which is rendered pursuant to said grievance procedure. If any action or administrative proceeding results in an award of damages against the owner, or if the owner incurs any expense to cure a violation of the ADA which has been brought pursuant to its grievance procedure, the contractor shall satisfy and discharge the same at its own expense.

The owner shall, as soon as practicable after a claim has been made against it, give written notice thereof to the contractor along with full and complete particulars of the claim. If any action or administrative proceeding is brought against the owner or any of its agents, servants, and employees, the owner shall expeditiously forward or have forwarded to the contractor every demand, complaint, notice, summons, pleading, or other process received by the owner or its representatives.

It is expressly agreed and understood that any approval by the owner of the services provided by the contractor pursuant to this contract will not relieve the contractor of the obligation to comply with the Act and to defend, indemnify, protect, and save harmless the owner pursuant to this paragraph.

It is further agreed and understood that the owner assumes no obligation to indemnify or save harmless the contractor, its agents, servants, employees and subcontractors for any claim which may arise out of their performance of this Agreement. Furthermore, the contractor expressly understands and agrees that the provisions of this indemnification clause shall in no way limit the contractor's obligations assumed in this Agreement, nor shall they be construed to relieve the contractor from any liability, nor preclude the owner from taking any other actions available to it under any other provisions of the Agreement or otherwise at law.

Representative's Name/Title (Print): JANA S BEVE - General Counsel
Representative's Signature: [Signature]
Name of Company: NYSTEC
Tel. No.: 315-717-7202 Date: 6/23/2014
518-431-7031

**Minority/Woman Business Enterprise (MWBE)
Questionnaire for Bidders**

Jersey City Ordinance C-829 establishes a goal of awarding 20% of the dollar amount of total city procurement to minority and woman owned business enterprises.

To assist us in monitoring our achievement of this goal, please indicate below whether your company is or is not a minority owned and/or woman owned business, and return this form with your bid proposal.

Business Name : New York State Technology Enterprise Corp (NYSTEC)
Address : 500 Avery Lane, Suite A Rome, NY 1344
Telephone No. : 518-431-7031 or 315-717-7202
Contact Name : Jana Belu behe@nystec.com

Please check applicable category :

Minority Owned Business (MBE)

Minority & Woman Owned
Business (MWBE)

Woman Owned business (WBE)

Neither

Definitions

Minority Business Enterprise

Minority Business Enterprise means a business which is a sole proprietorship, partnership or corporation at least 51% of which is owned and controlled by persons who are African American, Hispanic, Asian American, American Indian or Alaskan native, defined as follows:

African American: a person having origins in any of the black racial groups of Africa

Hispanic: a person of Mexican, Puerto Rican, Central or South American or other non-European Spanish culture or origin regardless of race.

Asian: a person having origins in any of the original peoples of the Far East, South East Asia, Indian subcontinent, Hawaii or the Pacific Islands.

American Indian or Alaskan Native: a person having origins in any of the original peoples of North America and who maintains cultural identification through tribal affiliation or community recognition.

Woman Business Enterprise

Woman Business Enterprise means a business which is a sole proprietorship, partnership or corporation at least 51% of which is owned and controlled by a woman or women.

OFFICE OF EQUAL OPPORTUNITY COPY

STATE OF NEW JERSEY
DEPARTMENT OF TREASURY
CERTIFICATE OF AUTHORITY

NEW YORK STATE TECHNOLOGY ENTERPRISE CORPORTION
0100915398

*I, the Treasurer of the State of New Jersey,
do hereby certify that the above-named
Foreign Non Profit Corporation organized under
the laws of New York, has complied with all
the requirements of Title 15A of the New
Jersey Statutes, and that the business or
activity of said Foreign Non Profit Corporation
to be carried on within the State of New Jersey
is such as may be lawfully carried on by a
Foreign Non Profit Corporation filed under the
laws of this State for similar business or activity.
The Certificate of Authority was duly filed
November 17th, 2003.*

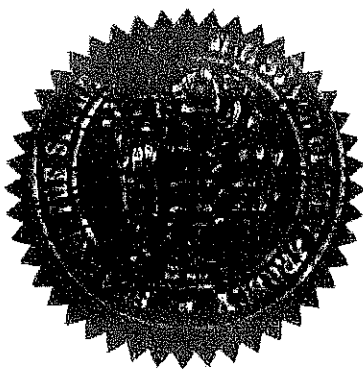

IN TESTIMONY WHEREOF, I have
hereunto set my hand and
affixed my Official Seal
at Trenton, this
18th day of November, 2003

A handwritten signature in cursive script, appearing to read "John E. McCormac".

John E McCormac, CPA
State Treasurer



CITY OF JERSEY CITY
DEPARTMENT OF PUBLIC SAFETY

PUBLIC SAFETY | 465 MARIN BOULEVARD | JERSEY CITY, NJ 07302
P: 201 547 4239 | F: 201 547 5298



MEMORANDUM

To: Council Members
From: James R. Shea, Director *JRS*
Date: June 18, 2014
Subject: Account Balance 01 201 25 265 405

Account information as of June 18, 2014:

Budget request:	\$320,000
Temporary budget:	\$196,000
Year to date expended:	\$ 82,675.22
Open encumbered:	\$ 71,909.90
Ending balance:	\$ 41,414.88

P.O. NO.	113907	NYSTEC				HIGHPOINT SOLUTIONS		INTEGRATED		RCC CONSULTANTS	
REQ. NO.	166055							COMPUTER SERVICES			
DIV/DEPT	FIRE HQ										
ITEM #	DESCRIPTION	QTY	UNIT	UNIT COST	EXT AMT	UNIT COST	EXT AMT	UNIT COST	EXT AMT	UNIT COST	EXT AMT
1	JC PUBLIC SAFETY	1	EA	\$ 24,943.00	\$ 24,943.00	\$ 36,000.00	\$36,000.00	NON	\$ -	NON	\$ -
2	COMMUNICATIONS			\$ -	\$ -			RESPONSIVE		RESPONSIVE	
3	ASSESSMENT			\$ -	\$ -						
4				\$ -	\$ -						
5				\$ -	\$ -						
6				\$ -	\$ -						
7				\$ -	\$ -						
8				\$ -	\$ -						
9				\$ -	\$ -						
10				\$ -	\$ -						
11				\$ -	\$ -						
12				\$ -	\$ -						
13				\$ -	\$ -						
14				\$ -	\$ -						
15				\$ -	\$ -						
		SUB-TOTAL			\$ 24,943.00		\$36,000.00		\$ -		\$ -
		SHIPPING/HANDLING			\$ -						\$ -
		TOTAL			\$ 24,943.00		\$36,000.00		\$ -		\$ -

NOTES:



New Jersey Division of Revenue

Revenue NJBGS

On-Line Business Registration Certificate Service

CERTIFICATE NUMBER 1034733 FOR NEW YORK STATE TECHNOLOGY
ENTERPRISE CORPORTION IS VALID.



STATE OF NEW JERSEY BUSINESS REGISTRATION CERTIFICATE

Taxpayer Name:	NEW YORK STATE TECHNOLOGY ENTERPRISE CORPORTION
Trade Name:	
Address:	200 AVERY LANE SUITE A ROME, NY 13441
Certificate Number:	1034733
Effective Date:	January 09, 2004
Date of Issuance:	April 23, 2014

For Office Use Only:
20140423140855178

Peter Folgado

From: Joseph T. Zieja [JZieja@NJJCPS.ORG]
Sent: Wednesday, June 18, 2014 7:40 AM
To: Peter Folgado
Cc: Tracy Zur
Subject: Assessment Vendors Contacted
Attachments: Assessment Vendors Contacted.pdf

Good Morning Peter,
I don't even know what made me save this, but on May 19th, these are the 3 vendors I contacted through their website. Highpoint is the only one that contacted me and eventually gave a quote 1 month later. These are in addition to NYSTEC.

Thanks

NYSTEC

YOUR INDEPENDENT TECHNOLOGY ADVISOR

Proposal for



Public Safety Communications Needs Assessment

Submitted to:

Deputy Chief Joe Zieja
Director of Public Safety Communications
425 Marin Boulevard
Jersey City, NJ 07302

Proposal Number 947TA

April 21, 2014

STATE OF NEW JERSEY
DEPARTMENT OF TREASURY
CERTIFICATE OF AUTHORITY

NEW YORK STATE TECHNOLOGY ENTERPRISE CORPORTION
0100915398

*I, the Treasurer of the State of New Jersey,
do hereby certify that the above-named
Foreign Non Profit Corporation organized under
the laws of New York, has complied with all
the requirements of Title 15A of the New
Jersey Statutes, and that the business or
activity of said Foreign Non Profit Corporation
to be carried on within the State of New Jersey
is such as may be lawfully carried on by a
Foreign Non Profit Corporation filed under the
laws of this State for similar business or activity.
The Certificate of Authority was duly filed
November 17th, 2003.*

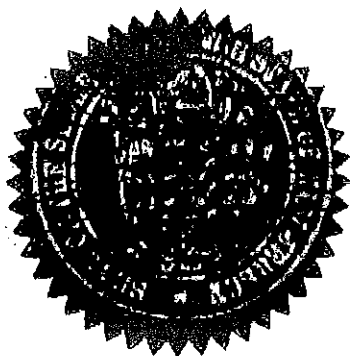

IN TESTIMONY WHEREOF, I have
hereunto set my hand and
affixed my Official Seal
at Trenton, this
18th day of November, 2003

A handwritten signature in cursive script, appearing to read "John E. McCormac".

John E McCormac, CPA
State Treasurer

Project Approach

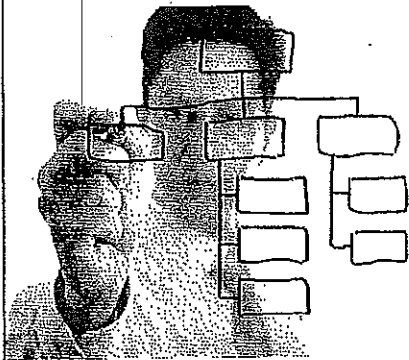

NYSTEC

YOUR INDEPENDENT TECHNOLOGY ADVISOR

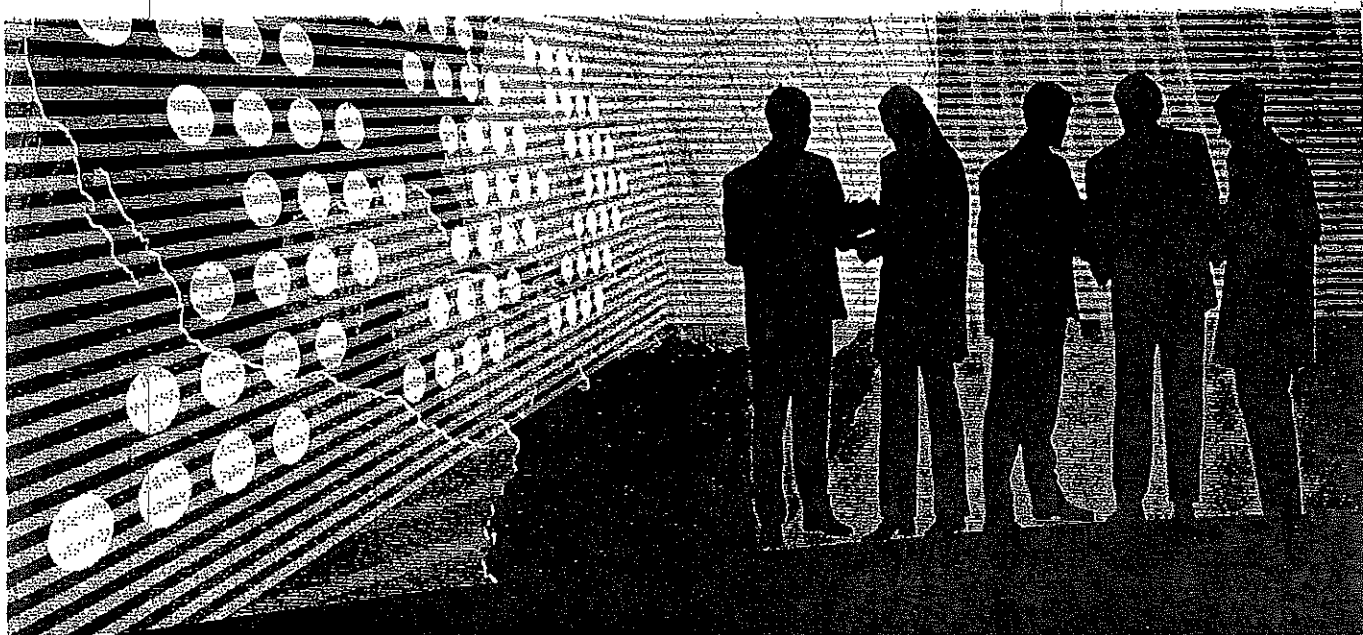

*DRAFT
Proposal for*

Jersey City Fire Department

for

Public Safety Communications Needs Assessment

Deputy Chief Joe Zieja
Jersey City Fire Department
425 Marin Boulevard
Jersey City, NJ, 07302

Proposal No. 947TA

April 21, 2014

CONTENTS

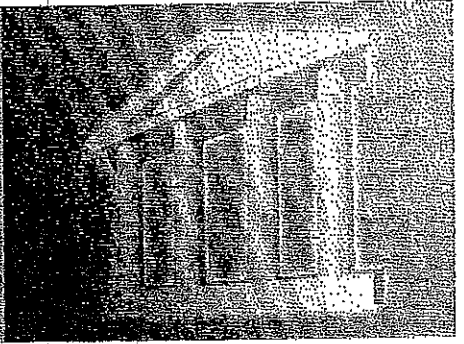

1	Project Approach	2
1.1	Introduction.....	2
1.2	NYSTEC Background.....	3
1.3	Statement of Work.....	3
1.4	Project Assumptions and other requirements.....	5
2	Project Milestones and Budget	8
2.1	Project Budget.....	8
3	Organizational Capability	12
3.1	Biographies of Proposed Team Members.....	12
3.2	Resumes.....	15
4	Contract Administration	28
4.1	Terms and Conditions.....	28
4.2	Payment Schedule.....	28
4.3	Contract Signature Page.....	29



NYSTEC CONTACT INFORMATION

Account Executive:

Mark J. Romano

Direct Line: (212) 599-4599
Cell Phone: (315) 956-4143
Fax: (315) 338-6124
E-Mail: mromano@nystec.com

Project Manager:

John Spring

Direct Line: (315) 334-7810
Cell Phone: (315) 378-6868
E-Mail: jspring@nystec.com

General Counsel & Chief Contracts Officer:

Jana S. Behe

Direct Line: (518) 431-7031
Cell Phone: (315) 717-7202
Fax: (518) 431-7037
E-Mail: behe@nystec.com

Office Locations:

NYSTEC (Rome)
500 Avery Lane, Suite A
Rome, NY 13441

NYSTEC (Albany)
540 Broadway, 3rd Floor
Albany, NY 13307

NYSTEC (New York City)
40 West 37th Street, Suite 401
New York, NY 10018

NYSTEC Website URL: www.nystec.com

OGS Contract site URL: <http://ogs.ny.gov/purchase/snt/awardnotes/79536T9700411can.HTM>



1 PROJECT APPROACH

1.1 INTRODUCTION

NYSTEC is pleased to present this proposal to the Jersey City Fire Department (JCFD) to provide a network assessment and analysis. Headquartered at 465 Marin Boulevard in Jersey City, NJ, the JCFD maintains a fleet of 28 units of front-line fire apparatus, including pumper trucks, ladder trucks, rescue trucks, a hazardous materials unit (HAZMAT), and a mask service unit (MSU).

Fire companies respond from 17 fire stations located throughout the City. The Fire Department responds to around 20,000 fire alarms, emergencies, and requests for medical assistance annually. All members of the Jersey City Fire Department receive first responder training and all Fire Department vehicles are equipped with automatic defibrillators. With the growth of the Jersey City waterfront, the City is now home to 142 high-rise buildings, including the tallest building in New Jersey, adding to the Fire Department's formidable task of protecting the citizens of Jersey City.

Originally founded in 1829 as the Volunteer Liberty Engine Company One, the Fire Department has grown with the City. Presently, the Jersey City Fire Department is comprised of 550 uniformed members and 50 civilian employees.

The six-year-old Communications Center, located at 75 Bishop Street, is currently run jointly by the JCFD and the Jersey City Police Department's Technical Division. Despite attempts by both the JCFD and the JCPD to keep up with upgrades, over the years of its existence, the center has become in need of repair and upgrading. In early February 2014, the Communications Center suffered a major outage and the City lost some critical functionality. Since then, the department has undertaken its own review and found many issues in terms of design, functionality, and backups. As such, the City is requesting assistance from NYSTEC to conduct an assessment of its public safety network and communications systems. The areas and systems NYSTEC will perform analysis of include:

- MPLS vs. Private Fiber
- Present and future needs for Network Bandwidth connections (LAN/WAN)
- Support contracts
- Technical Support Staff

The JCFD is requesting that NYSTEC conduct a complete review of its listed systems, create a technology replacement schedule, and determine technology direction and recommendations for the communications center. While NYSTEC's work will cover many areas within the JCFD,



JCPD, and potentially other Jersey City Divisions, NYSTEC will report directly to the Director's office only. The full scope of work is identified in Section 1.3.

1.2 NYSTEC BACKGROUND

NYSTEC is a private, not-for-profit corporation based in Rome, New York. NYSTEC, created in 1995 under the sponsorship of the New York State Science & Technology Foundation, helps its government clients plan and manage the acquisition, implementation, and security of new IT and Communications systems. Since NYSTEC's inception, its consultants have worked with Air Force Research Laboratory (AFRL) personnel to transfer methodologies and evaluate new technology. NYSTEC works with its clients to achieve better results with both their existing and new technology systems.

NYSTEC's Information Security, Networks, and Acquisitions and Systems Integration Management (SIM) Practices, like the corporation, are based in Rome, New York. The professionals of NYSTEC have exceptional experience in the areas of systems planning, systems acquisition, integration, testing, and quality assurance. These methodologies have been developed in conjunction with the AFRL, and NYSTEC professionals continue to collaborate on these methodologies and techniques with the AFRL.

1.3 STATEMENT OF WORK

The following outlines the tasks NYSTEC will perform for the JCFD.

TASK 1: KICK-OFF MEETING AND PROJECT PLANNING

Kick-off Meetings - This subtask provides the groundwork and level of understanding for all the project team members—from the JCFD and NYSTEC.

Scope Clarification - The NYSTEC Team shall work with the JCFD Project Team to discuss and clarify the scope of the project.

Project Plan - NYSTEC will update the initial project plan developed for this proposal to reflect the most current information available.

Task1 Deliverables:

- Kick-off presentation
- Project Plan (in Microsoft Project)



TASK 2: AS-IS NETWORK AND SYSTEM INVENTORY AND ASSESSMENT

Task 2.1: Conduct Network Assessment and Document As-Is conditions: NYSTEC will work with the JCFD to compile information required to properly assess and document the local- and wide-area wired networks (LAN and WAN). NYSTEC will review existing system reports, design drawings, and inventories and will perform on-site inventories and assessments at the following locations:

- JCFD Headquarters, 465 Marin Boulevard
- Communications Center, 75 Bishop Street

NYSTEC's work will focus on the following areas:

- **Assess MPLS vs Private Fiber.** NYSTEC will review JCFD's fiber-optic options and conduct a cost analysis based on its existing infrastructure as well as a review of its proposed contract with Verizon. NYSTEC will review the design and the time constraints currently faced by JCFD.
- **Assess Network Bandwidth connections including present and future needs.** NYSTEC will review JCFD's current utilization statistics, existing systems, trending data, and previous recommendations. In addition, NYSTEC will review plans for future technology deployments and provide recommendations for growth.
- **Assess support contracts.** NYSTEC will assess current technical-support contracts that JCFD currently possesses. In particular, NYSTEC will review existing hardware and End of Life (EOL) and End of Service (EOS) windows, and provide potential third-party support recommendations, if available.
- **Assess Technical Support Staff Needs.** NYSTEC will assess the JCFD's current technical-support staff needs in relation to its current network infrastructure. NYSTEC will review current policies and staffing and provide best practice recommendations to the JCFD on possible future staffing needs.

In order for NYSTEC to determine this information, NYSTEC will meet with various stakeholders within both the Jersey City Fire Department as well as the Police Department. The JCFD will assist NYSTEC in setting up those information-exchange meetings.

Task 2.2: Develop Recommendations: Upon completion of Task 2.1, NYSTEC will develop a report detailing its assessment of the Jersey City Fire Department's current network environment and outline steps it could take to improve its performance. NYSTEC will also develop a high-level replacement schedule and suggest a technology direction the Department may take in order to gain efficiencies and overall improvement in its operations.

Task 2 Deliverables:



- Validation of the JCFD's circuit and hardware inventory spreadsheets (MS Excel)
- As-is assessment and recommendations report (MS Word)

TASK 3: NYSTEC PROJECT MANAGEMENT AND PROJECT ADMINISTRATION

NYSTEC Project Management - NYSTEC will assign a Project Manager to whom all communications may be addressed and who has the authority to act for NYSTEC in all aspects of the services to be performed pursuant to this proposal. The NYSTEC Project Manager will be responsible for directing the work of NYSTEC's staff members.

Additional Tasks - Project Change Control - Should additional tasking be identified as the project progresses, NYSTEC shall support and provide additional tasking plans. NYSTEC shall, based on a task requirement's definitions from the JCFD Project Manager, develop a response describing the task's technical scope, desired work product, schedule, and price. NYSTEC shall submit this response to the JCFD Project Manager. Each request for additional NYSTEC services shall have a response due date determined by the JCFD Project Manager.

Task 3 Deliverables:

- Status Reports and Supporting Documents (as needed)

1.4 PROJECT ASSUMPTIONS AND OTHER REQUIREMENTS

Upon receiving written notice to proceed, NYSTEC will coordinate the performance of services with the JCFD Project Manager. The following assumptions apply:

- The JCFD will provide temporary workspace for NYSTEC employees, at no charge, while at JCFD facilities. The JCFD will provide building access as required for the project.
- NYSTEC's primary role on this effort is to conduct a network assessment which may require tasking being completed by either in-house JCFD technical staff or vendor-provided contractors. NYSTEC shall, in no way, be liable for the actions or inactions of these third-party contracting entities or for any subsequent failure of the contractors, as selected by the JCFD, to meet performance functions and goals.
- NYSTEC staff will not be responsible for hands-on installation, implementation, or related infrastructure work. NYSTEC will inform the JCFD of issues NYSTEC determines to be critical.
- For all tasks, the following assumptions were used to estimate time and price:
 - The NYSTEC Project Manager will work closely with the JCFD Project Manager to manage the overall project scope and the quality of the project reports.



- The JCFD will assign a Project Manager to serve as the primary point-of-contact and to ensure that work assigned to JCFD personnel is completed in accordance with the Project Schedule.
- The Customer, Commenter, and Approver of all documentation will solely be the assigned JCFD Project Manager. It will be the responsibility of the assigned JCFD Project Manager to obtain comments and approval from any other JCFD organizations, if necessary.
- Conclusion of this project within the schedule and cost proposed herein requires NYSTEC's timely receipt from the JCFD of the required information and resources. The JCFD and NYSTEC will mutually agree upon all information and resources to be utilized during the course of this project.
- NYSTEC will submit Summary Reports to the JCFD on a schedule to be determined between the JCFD Project Manager and the NYSTEC Project Manager.
- In addition to a NYSTEC Project Manager, NYSTEC will assign a Project Director who is responsible for oversight of the project and exercises overall responsibility for the success of the project. The Project Director has sufficient experience and expertise to act as the primary liaison between NYSTEC and the JCFD project sponsor and to assume overall responsibility for NYSTEC's performance under the contract. The Project Director has direct access to the members of NYSTEC's Leadership Team and has the authority to call upon the experience, expertise, and resources of NYSTEC to assure proper performance of the contract.

**Project Schedule
and Budget**





2 PROJECT MILESTONES AND BUDGET

2.1 PROJECT BUDGET

The cost for the project is presented as \$24,943.00.

2.1.1 NYSTEC PROJECT BUDGET

E. Labor Expenses	NEY '14 At Home Rates	NEY '14 At Home Hours	NEY '14 At Home Dollars	NEY '14 Travel Rates	NEY '14 Travel Hours	NEY '14 Travel Dollars
Senior Network/Security Analyst	\$234.00	0	\$0	\$289.00	0	\$0.00
Network Security Analyst	\$216.00	0	\$0	\$271.00	0	\$0.00
Senior Engineer Manager	\$187.20	10	\$1,872	\$242.20	10	\$2,422.00
Engineer/Analyst VI	\$178.20	0	\$0	\$233.20	0	\$0.00
Engineer/Analyst V	\$168.30	0	\$0	\$223.30	0	\$0.00
Senior Engineer/Analyst IV	\$159.30	40	\$6,372	\$214.30	30	\$6,429.00
Engineer/Analyst IV	\$144.90	0	\$0	\$199.90	0	\$0.00
Senior Engineer Analyst III	\$130.50	0	\$0	\$185.50	0	\$0.00
Engineer/Analyst III	\$121.50	0	\$0	\$176.50	0	\$0.00
Senior Engineer/Analyst II	\$108.00	0	\$0	\$163.00	0	\$0.00
Engineer/Analyst II	\$98.10	80	\$7,848	\$153.10	0	\$0.00
Senior Engineer/Analyst I	\$93.60	0	\$0	\$148.60	0	\$0.00
Engineer/Analyst I	\$89.10	0	\$0	\$144.10	0	\$0.00
Support Specialist IV	\$74.70	0	\$0	\$129.70	0	\$0.00
Support Specialist III	\$65.70	0	\$0	\$120.70	0	\$0.00
Support Specialist II	\$51.30	0	\$0	\$106.30	0	\$0.00
Support Specialist I	\$36.90	0	\$0	\$91.90	0	\$0.00
Total Hours and Dollars by at Home & Travel rates		130	\$16,092		40	\$8,851.00
			Total hours		170.0	
Total Time and Materials Ceiling Amount						\$24,943.00

Please Note:

1. The quantity of hours proposed for each Labor Category are merely provided as a basis of estimate, the sole purpose for which is to facilitate the establishment of a not to exceed ceiling amount for a Time & Materials type effort.
2. The actual composition of hours incurred by Labor Category and associated rates may vary from those that form this basis of estimate. This proposal shall remain valid for sixty (60) days from the date of signature. NEY denotes NYSTEC Fiscal Year (October 1 - September 30). Any effort required beyond September 30, 2014 may be impacted by NEY 2015 rates.
3. NYSTEC At Home rates are for effort conducted at NYSTEC's home office. NYSTEC Travel rates are for effort conducted when NYSTEC employees are required to travel to Client facilities. NYSTEC's Travel rate is based upon our most favored At Home rates for all OGS Contract CMR524 users. NYSTEC's Travel hourly rate is inclusive of all typical travel and expenses. Client will not be invoiced separately for travel expenses.

Figure 1, Budget



2.1.2 NYSTEC PROJECT SCHEDULE

An estimated project schedule is shown in Figure 2. Please note that achieving the timeline will be dependent on the availability of appropriate project stakeholders and on the timely approval of deliverables.

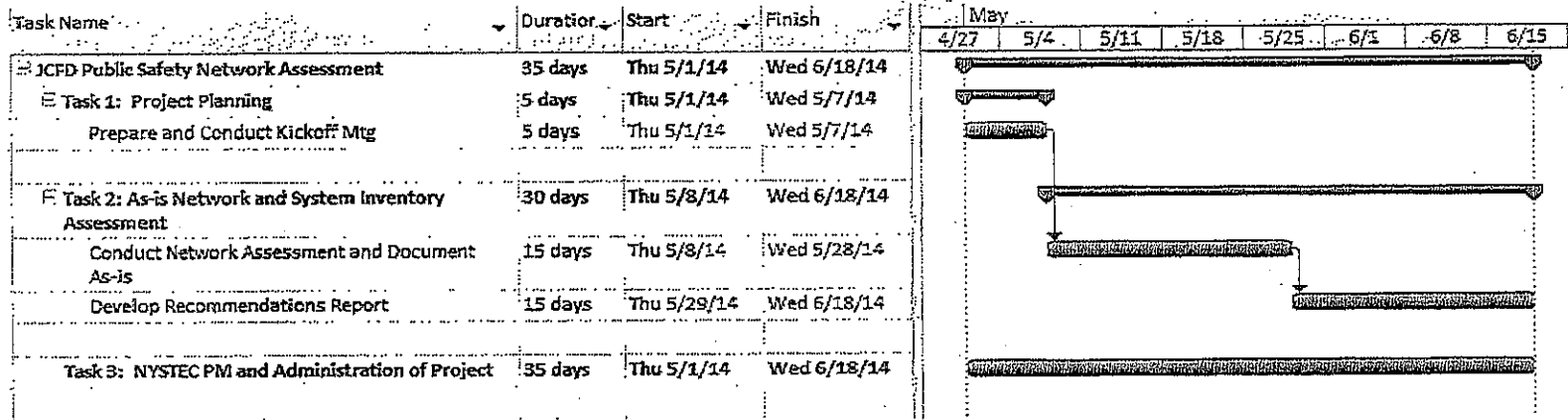

Figure 2, Estimated Project Schedule



2.1.3 ADDITIONAL EFFORT

Should the JCFD require additional NYSTEC assistance outside of the proposed payment schedule contained in Figure 1, this request shall be made in writing and documented in the project file. The additional assistance will be in accordance with the NYSTEC labor categories and rates below. Additional labor categories, and associated effort, may be added by the JCFD based upon the needs of the project at the college's sole discretion.

NYSTEC OGS Billing Title	NFY 2014	NFY 2015	NFY 2016	NFY 2017
	Labor Only	Labor Only	Labor Only	Labor Only
Sr. Network Security Analyst	\$234.00	\$241.02	\$248.25	\$255.70
Network Security Analyst	\$216.00	\$222.48	\$229.15	\$236.03
Sr. Engineer/Manager	\$187.20	\$192.82	\$198.60	\$204.56
Engineer/Analyst VI	\$178.20	\$183.55	\$189.05	\$194.72
Engineer/Analyst V	\$168.30	\$173.35	\$178.55	\$183.91
Senior Engineer/Analyst IV	\$159.30	\$164.08	\$169.00	\$174.07
Engineer/Analyst IV	\$144.90	\$149.25	\$153.72	\$158.34
Senior Engineer/Analyst III	\$130.50	\$134.42	\$138.45	\$142.60
Engineer/Analyst III	\$121.50	\$125.15	\$128.90	\$132.77
Senior Engineer/Analyst II	\$108.00	\$111.24	\$114.58	\$118.01
Engineer/Analyst II	\$98.10	\$101.04	\$104.07	\$107.20
Senior Engineer/Analyst I	\$93.60	\$96.41	\$99.30	\$102.28
Engineer/Analyst I	\$89.10	\$91.77	\$94.53	\$97.36
Support Specialist IV	\$74.70	\$76.94	\$79.25	\$81.63
Support Specialist III	\$65.70	\$67.67	\$69.70	\$71.79
Support Specialist II	\$51.30	\$52.84	\$54.42	\$56.06
Support Specialist I	\$36.90	\$38.01	\$39.15	\$40.32

NFY Denotes NYSTEC Fiscal Year
 NFY 2014 - October 1, 2013 - September 30, 2014
 NFY 2015 - October 1, 2014 - September 30, 2015
 NFY 2016 - October 1, 2015 - September 30, 2016
 NFY 2017 - October 1, 2016 - September 30, 2017

Figure 2, Additional Effort/Labor Categories

Project Team

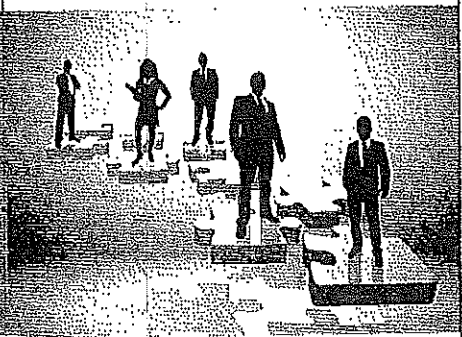



3 ORGANIZATIONAL CAPABILITY

3.1 BIOGRAPHIES OF PROPOSED TEAM MEMBERS

This page presents brief biographies of the proposed members of NYSTEC's project team. Detailed resumes follow.

<p>BILL MCBRIDE <i>Project Director Senior Engineer/Manager</i></p> 	<p>Bill McBride oversees NYSTEC's Converged Networks Practice, directing a team of network professionals performing requirements analysis, quality assurance, providing design solutions, and managing Information Technology (IT) projects of various sizes. Bill has more than 17 years of experience in designing, implementing, and managing large scale IT projects in network infrastructure, server and application migrations, data center, telecommunication broadband, and public safety. Bill has extensive experience in the private and public sectors, having worked at several wholesale telecommunication providers as well as with various New York State and New York City agencies. Bill holds a B.S. in Civil and Environmental Engineering from Clarkson University.</p>
---	---

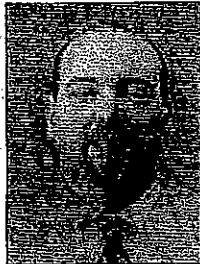
<p>JOHN SPRING <i>Project Manager Senior Engineer/Analyst IV</i></p> 	<p>John Spring is a network design engineer with 20+ years of combined experience in system design and configuration, program management, client support, and system troubleshooting. Prior to joining NYSTEC in the summer of 2005, John worked at NEC Unified Solutions as a Senior Network Engineer responsible for the design and implementation of complex data networks. At NEC, John supervised approximately 20 engineers who provided voice and data assistance to clients nationwide. Throughout his career, John has provided engineering support on diverse networks and technologies including LANs, MANs, WANs, campus applications, hardware and software, Unix-based systems, and for assorted projects involving computer-telephony integration. John is knowledgeable in various computer-programming languages, operating systems, and networking technologies. He currently holds, or has held, a Cisco Certified Design Associate (CCDA), Cisco Certified Networking Associate (CCNA), Cisco Certified Networking Professional (CCNP), NetScout Certified Administrator (NCA), and a Certified Wireless Network Administrator (CWNA). John is also certified in Cisco Wireless Specialization and is currently pursuing certifications in four additional technology areas.</p>
---	--



COREY PETERS
Engineer/Analyst II



Corey Peters is a Network Consultant who joined the NYSTEC team in 2012. Corey holds a BS in Physics, MS in Advanced Technology, and is currently pursuing an MSEE/PhD in Electrical Engineering. Corey's background includes optical communication network design and analysis, advanced experimental photonic computation, nanoscale and semiconductor device fabrication, and RF network design and analysis. Corey has worked with MATLAB, Origin, and other similar software packages for analytical applications. While with NYSTEC, he has provided technical assistance on several data center and disaster-recovery projects for CUNY and BMCC.

KEVIN JOYCE
Engineer/Analyst IV

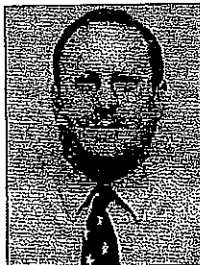

A Network Consultant on the NYSTEC team who joined the company in April 2012, Kevin has more than 21 years of experience with network engineering and management. He has planned, engineered, maintained, and overseen upgrades of diversified network and IT systems for various organizations in the fields of health care, insurance, banking, and government defense. Kevin is well versed in the latest technologies and best practices for network management, administration, and security. He holds a Master's degree in Telecommunications from the University of Colorado at Boulder, and is an active member of multiple international associations for Security and Electronics and also holds positions on IT advisory boards for multiple educational institutions in Central New York State.

JOHN MOUNTEER
Engineer/Analyst IV



John has more than 25 years of experience in the IT fields of networking, voice and data systems, and policies and procedures, in the areas of design, operations and procurement. He has experience with managing and advising on numerous systems, network, data center, and related projects, for business, state government, local government, and education customers.



Other NYSTEC resources: NYSTEC will assign other consultants to the project as deemed necessary to complete the tasks. We have a variety of skill sets that we can draw upon if the need arises.



3.2 RESUMES

BILL MCBRIDE

*Project Director
Senior Engineer/Manager*

Education & Certifications

BS, Civil and Environmental Engineering,
Clarkson University



Background

Bill McBride oversees NYSTEC's Converged Networks Practice, directing a team of network professionals performing requirements analysis, quality assurance, providing design solutions, and managing Information Technology (IT) projects of various sizes. Bill has more than 17 years of experience in designing, implementing, and managing large scale IT projects in network infrastructure, server and application migrations, data center, telecommunication broadband, and public safety. Bill has extensive experience in the private and public sectors, having worked at several wholesale telecommunication providers as well as with various New York State and New York City agencies. Bill holds a B.S. in Civil and Environmental Engineering from Clarkson University.

Professional and Industry Experience

New York City Department of Information Technology and

Telecommunications (DoITT) - Oversaw NYSTEC engineering and consultant activities on the CityNet project. For the upgrade of New York City government's fiber optic network, NYSTEC has provided fiber characterization studies, ring node designs, and comprehensive PMQA services. Bill interfaced with the client and provided engineering direction for the endeavor.

New York City Department of Information Technology and

Telecommunications (DoITT) - Lead Network Engineer for NYSTEC on the 60 Hudson Street Node Relocation Project. The 60 Hudson Street project involved relocating one of DoITT's Core Ring network nodes within this facility while maintaining service across the CityNet network. Responsible for Project Monitoring and Quality Assurance during the planning, design, testing, and implementation phases of the project.

Cavaller Telephone - As OSP Engineering Manager:

- Managed the OSP Engineering team consisting of Supervisors, Engineers, CAD Analysts, and Locators.
- Provided facilities-based connectivity to more than 100 Local Exchange Carrier offices and six (6) network-switch sites in four (4) different states across the network.
- Was responsible for designing the Synchronous Optical Network (SONET) ring topologies for each new market.
- Utilizing a GIS-based system, managed the development of a network database.

Cavaller Telephone - As an OSP Engineer:

- Was solely responsible for the entire Elantic Telecom (former DTI)



	<p>network that accommodates approximately 6,000 route miles across 15 states.</p> <ul style="list-style-type: none"> - In order to monitor and control all potential service-affecting related issues, interfaced on a regular basis with all third-party vendors that supply dark fiber and collocation to Elantic Telecom. - Engineered the successful reconstruction of Elantic Telecom's Northern Virginia and Washington, DC network within a six-month period. - During the Elantic Telecom Chapter 11 bankruptcy, designed and implemented numerous consolidation projects that led to annual savings of \$2.4 million. <p>Dominion Telecom, Inc. - As an Engineer III in Design and Operations:</p> <ul style="list-style-type: none"> - Designed and implemented dark-fiber routes and collocation services for internal and external clients. - Approved all technical requirements related to Legal contracts involving Dark Fiber Indefeasible Right to Use (IRU) Agreements and Dark Fiber Lease Agreements, as well as Lit Capacity Contracts. - Was responsible for providing detailed design drawings, project scopes, and securing subcontractors to relocate the network when in conflict with third-party construction projects. - Provided critical information to upper management and Legal Counsel during the due-diligence process for the Telergy assets, along with the Merger Agreement with Elantic Networks, Inc. <p>Telergy, Inc. - As a Senior OSP Engineer, then OSP Engineering Manager:</p> <ul style="list-style-type: none"> - Managed a New York State engineering team — consisting of 13 Outside Plant Engineers and 2 Project Managers — that designed and constructed approximately 1,500 route miles within a three-year span. - Developed the Engineering and Construction standards for the Company. - Incorporated an accounting system on the Engineering prints that captured the necessary financial information required by the Company's accounting department. - Interfaced with Regulatory Agencies and Right-of-Way providers on a regular basis to ensure that the company was adhering to all of the project procedures and guidelines. - Supervised an engineering force consisting of five OSP Engineers responsible for providing the construction department with a standardized set of engineering work prints to construct Telergy's fiber-optic network. - Pioneered the design and installation of fiber-optic cable in the Con Edison underground conduit system in New York City. <p>MFS Network Technologies - As a Field Engineer, then Construction Supervisor for Long Island and New York City:</p> <ul style="list-style-type: none"> - Supervised a construction and engineering force consisting of 8
--	--



Field Engineers on an 85-mile diverse high-speed fiber-optic network with 4 major rings extending from Manhattan, NY, to Long Island, NY.

- Interfaced with municipal and government permitting officials on a regular basis to maintain the project schedule.
- Interpreted underground utility records, power utility grid maps, railroad validation maps, and plat maps in order to prepare engineering field notes.

JOHN SPRING

*Project Manager
Senior Engineer/Analyst IV*

Education & Certifications

BA in Mathematics with Computer Science concentration, SUNY Potsdam, Potsdam NY
Course in PASCAL, Syracuse University, Syracuse NY



Background

John Spring is a network design engineer with 25+ years of combined experience in system design and configuration, program management, client support, and system troubleshooting. Prior to joining NYSTEC in the summer of 2005, John worked at NEC Unified Solutions as a Senior Network Engineer responsible for the design and implementation of complex data networks. At NEC, John supervised approximately 20 engineers who provided voice and data assistance to clients nationwide. Throughout his career, John has provided engineering support on diverse networks and technologies including LANs, MANs, WANs, campus applications, hardware and software, Unix-based systems, and for assorted projects involving computer-telephony integration. John is knowledgeable in various computer-programming languages, operating systems, and networking technologies. He currently holds, or has held, a Cisco Certified Design Associate (CCDA), Cisco Certified Networking Associate (CCNA), Cisco Certified Networking Professional (CCNP), NetScout Certified Administrator (NCA), and a Certified Wireless Network Administrator (CWNA). John is also certified in Cisco Wireless Specialization and is currently pursuing certifications in four additional technology areas.

Professional and Industry Experience

New York City Department of Environmental Protection - Currently a systems engineer for NYSTEC on a Citywide Wireless Automated Metering project. Duties include Project Monitoring and Quality Assurance activities, as well as design consultation during the planning, testing, and implementation of the network.

New York City Department of Information Technology and Telecommunications - Currently the lead systems engineer for NYSTEC on a Citywide Mobile Wireless Network project—the New York City Wireless Network (NYCWIN). The NYCWIN will support the needs of public safety and transportation department agencies—providing high-speed (wireless) data and video transmission. Duties include Project Monitoring and Quality Assurance activities and design consultation during the planning, testing, and implementation of the network.

NEC Unified Solutions, East Syracuse NY - Served as:

- Senior Network Engineer responsible for pre-sale data network



design and post-sale implementation of complex data networks. Provided comprehensive integration of voice, data, and video for inter- and intra-campus applications, and resolved installation problems.

- Supervisor, Voice and Data Technical Assistance Center (TAC) managing 15 to 20 engineers on diverse project assignments. Helped to develop comprehensive plans and procedures for the company's nationwide Technical Assistance Center. Provided ongoing engineering support to meet customer requirements.
- Senior Systems Engineer for client data networks. Provided integration, implementation, and engineering support on client voice, data, and video networks.
- Field Engineer configuring and installing voice-related applications servers in medical and education markets.

Business Records Corporation, East Syracuse NY - Served as:

- Product Specialist responsible for scheduling software and hardware installations and training. Supervised technical support and staff. Trained clients, sales professionals, and support personnel on installation and maintenance procedures. Served on the company's national software control panel to monitor software development and set up software distribution services.
- Technical Support Specialist responsible for post-sale computer support, troubleshooting, and training.



COREY J. PETERS

Engineer/Analyst II

Education & Certifications

- MSEE/PhD, Columbia University (currently attending)
- MS Advanced Technology, SUNYIT, State University of New York
- BS Physics, cum laude, University at Albany, State University of New York
- Optics/Optical communication specialization
- Independent undergraduate research



Background

Corey Peters is a Network Consultant who joined the NYSTEC team in 2012. Corey holds a BS in Physics, MS In Advanced Technology, and is currently pursuing an MSEE/PhD in Electrical Engineering. Corey's background includes optical communication network design and analysis, advanced experimental photonic computation, nanoscale and semiconductor device fabrication, and RF network design and analysis. Corey has worked with MATLAB, Origin, and other similar software packages for analytical applications. While with NYSTEC, he has provided technical assistance on several data center and disaster-recovery projects for CUNY and BMCC.

Professional and Industry Experience

City University of New York (CUNY)

- Computing & Information Services (CIS) - Provided technical assistance in designing and overseeing the build-out of a Disaster Recovery site responsible for all CUNY CIS major applications and services. Duties included project monitoring, quality assurance, site procurement, technical drawings, and network design.
- BMCC - Performed preparation work (site visits, as-built documentation, necessary recommendations, etc.) for the relocation of BMCC's data center. Coordinated with various engineering companies and vendors to provide general construction requirements and project plans. Provided technical details, drawings, and network documentation for BMCC's network team. Assisted in the development of a disaster recovery/high availability plan for BMCC. Performed RF/WIFI analysis of BMCC's entire wireless network in order to provide revised wireless network design and follow up recommendations. Oversaw the implementation of prior recommendations related to optical, Ethernet, wireless, and infrastructure design.
 - o Filterman Hall - Assessment of as-is data center space resulting in detailed reports and recommendations retrofitting data center to abide by industry best practices.
 - o 70 Murray St - Provided data center design and associated network redesign supporting the relocation of local data center. Project is ongoing.
- 119 W. 31st St. - Provided technical assistance in the relocation and build-out of a new network and data center. Provided a project plan and network design. Performed all necessary surveys and visits to provide detailed documentation of as-is environment and recommendations for follow up build-outs. Worked closely with vendors to ensure properly engineered solutions were provided and deployed for site.

NYC DoITT

- CityNet - Worked closely with DoITT's optical network team to



outfit the five boroughs with an expansive optical network. Worked with internal team and Cisco resources to deploy network equipment, provide insight regarding technical details required for a fully functional optical network abiding to industry's standards and best practices, and provided project sponsor with highly detailed documentation related to project's build-out. The project is in its later phase and upgrades are ongoing.

Air Force Research Laboratory (AFRL) – As co-investigator for the cluster state quantum information science experimental team:

- Developed both integrated and fiber-based systems for computing and communication efforts
- Constructed patent-pending optical crystal design for the generation of multiple entangled qubits
- Co-developed optical signal detection device design
- Investigated the detector design's construction.

AFRL Student Temporary Employment Program (STEP) – As an Intern Physicist (in conjunction with completing graduate work) with the Quantum Computing Group in the Emerging Computing Technologies branch of the Air Force Research Lab:

- Assisted researchers in tasks such as high-energy laser operation and experiment design
- Developed analysis protocol for multiple lab tests, including quantum state tomography
- Performed optical networking and communication simulations and experiments

Griffiss Institute – As a Research Consultant assisting with the quantum information science team at the Air Force Research Lab:

- Assisted in the design and development of an experimental testbed for a photon-based quantum-computing platform



KEVIN JOYCE
Engineer/Analyst IV

Education & Certifications

M.S. in Telecommunications, University of Colorado at Boulder
B.S. in Electrical Engineering Technology, SUNY IT at Utica/Rome
Aruba Certified Mobility Associate, Aruba Networks

Professional Memberships

Senior Member, Information Systems Security Association (ISSA); Founding Member and Treasurer, Central New York Chapter
Member, Institute of Electrical and Electronics Engineers (IEEE)
Member, SUNY IT CyberSecurity Network and Computer Security Advisory Board
Member, Mohawk Valley Community College CyberSecurity Advisory Board



Background

A Network Consultant on the NYSTEC team who joined the company in April 2012, Kevin has more than 21 years of experience with network engineering and management. He has planned, engineered, maintained, and overseen upgrades of diversified network and IT systems for various organizations in the fields of health care, insurance, banking, and government defense. Kevin is well versed in the latest technologies and best practices for network management, administration, and security. He holds a Master's degree in Telecommunications from the University of Colorado at Boulder, and is an active member of multiple international associations for Security and Electronics and also holds positions on IT advisory boards for multiple educational institutions in Central New York State.

Professional and Industry Experience

NYS Workers' Compensation Board (WCB), Network Assessment, Design, and Implementation Project: Met with staff to perform network assessment of current environment including topology design and review, a hardware assessment, and a network performance review. Additional tasks included gathering business and functional requirements for the network and recommending system improvements.

Borough of Manhattan Community College (BMCC), Application Dependency Mapping task: Worked with college staff to develop dependency-mapping matrix that identified application owners, supporting servers, supporting services, and infrastructure dependencies. Created product comparison matrix of multiple Application Dependency mapping vendors to help client choose best product. Assisted staff members in developing test and failover plans for their critical applications. This information fed directly into the college's Disaster Recovery Plan.

CUNY, Data Life Cycle Management (DLCM): Interviewed staff members to gather data on current backup methods and procedures. Helped create detailed report which amalgamated information on applications, storage, backup software, and backup methodologies and provided recommendations for future backup plans.

CUNY, Data Center Relocation: Attended bi-weekly construction meetings and break-out meetings as needed. Worked with team to develop product comparison matrices for Cabinets, power distribution units, console servers, cabling and cable management, and Data Center Infrastructure Management (DCIM) systems.

DoITT, New York City Wireless Network (NYCWIN): Developed Disaster Recovery Plan for Wireless sites. This plan included provisions for personnel notification, communications, travel, and equipment augmentation/replacement. Included composing checklists for personnel to follow to ensure proper equipment was ready for deployment as well as check-in procedures to make sure equipment



was stored properly after use.

DASNY - CUNY School of Law: As Network Consultant, assisted in the IT relocation of the CUNY School of Law from Flushing to Long Island City. Updated projected plans, conducted inventory, coordinated new site data center layout. Coordinated telecommunications, network, and cable TV installations. Assisted in SAN migration from old site/old San to new SAN at the new site. Coordinated server moves and rack installations as well as assuring proper power for all equipment since new data center provided 208 vac vs 120 vac at old location. Performed Quality Assurance checks on wired and wireless networks. Assisted in VOIP phone deployment and testing. Created final rack elevations for MDF and IDFs to submit to client for their records.

NCC (New Community College): Worked with staff and contractor to coordinate the removal of obsolete cabling and install new Category 6 and fiber optic cable plant. Included monitoring installation and ensuring existing live connections were not disturbed. Created rack elevations for MDF and IDFs.

CUNY Ring Upgrade: Worked with CIS staff to upgrade fiber optic ring connecting City University of New York colleges in to 10 Gbps redundant optical ring. Inventoried equipment, coordinated new equipment connections at 8 locations. Also included monitoring and documenting fiber optic testing to certify cable performance.

Mohawk Valley Imaging: As IT Consultant, set up and configured networks and systems in doctors' homes. Configured workstations, monitors, and Virtual Private Network (VPN) connections to hospital network. Installed software for Picture Archiving and Communications Systems (PACs), dictation, and monitor calibration. Maintained server to remotely calibrate monitors enabling doctors to do final reads from home.

St. Elizabeth Medical Center, Utica, NY: As Network Manager of the IT Department, oversaw network operation, management, and security for LAN, WAN, WLAN, and Internet for hospital, College of Nursing, and 14 remote sites.

- Maintained four Cisco Adaptive Security Appliances (ASAs, or firewalls) providing 35+ site-to-site VPNs and more than 440 SSL VPNs to enable access for staff members and outside providers. Wrote VPN installation instructions for end users, performed troubleshooting, resolved connectivity problems, and assisted users with installation and setup.
- Responsible for 17 Cisco routers and 80+ switches/hubs, as well as a 14-building Aruba Networks Wireless LAN with 100+ access points and corporate, guest service, and vendor set identifiers (SSIDs).
- Performed software and patch installations, hardware/software troubleshooting, and upgrades. Monitored client connectivity and adjusted coverage areas.



- Verified accuracy of data circuit bills and approved them.
- Coordinated upgrade of Internet and 13 WAN connections to provider-based Multiprotocol Label Switching (MPLS) network for disaster recovery and cost savings. Maintained Barracuda Web filter and Barracuda Spam filter. Participated on disaster-preparedness team.
- Presented bi-weekly lectures at new employee orientations. These included briefings on confidentiality, HIPAA, security policies, and safe computing practices.
- Assisted contractor with network core upgrade to Cisco Nexus switches with 10 Gbps backbone and new switches for communications closets. Shared on-call rotation for network, systems, and data center. Assisted with data-center infrastructure maintenance and upgrades including power supplies, air conditioners, and network cabling.

The Hartford Insurance Company, New Hartford, NY: Served as Team Leader in the Business Technology Department. Supervised 10 employees including systems administrators, technology trainers, telephone technician, and facilities coordinator. Oversaw help-desk operation supporting 600 users.

Herkimer County Trust/SBU Bank, Little Falls, NY: Served as Network Operations Manager and Assistant Vice President of the IT Department. Oversaw network administration for LAN and WAN, including maintenance, troubleshooting, and equipment upgrades at headquarters and 12 branch sub-networks. Supervised computer-room staff with processing functions and computer help desk. Responsible for acquisition, operations, and maintenance of PC hardware and software, Windows servers, and Citrix Metaframe/NT Terminal Server. Directed network and system security including IT policy updates, SonicWall firewall maintenance, and security patches.

Rome Research Corporation at Air Force Research Lab (AFR), Rome, NY: Served as Network Analyst and Lead Test Engineer supporting the Survivable ATM (SATM) program. Tested developmental hardware and software. Principal testing stressed Transmission Control Protocol (TCP) and User Datagram Protocol (UDP) performance over wireless Asynchronous Transfer Mode (ATM) networks. Set up and configured Sun workstations, ATM switches, Video Teleconference software, and network test and measurement software. Deployed a wide variety of test equipment, carried out test plans, configured supporting equipment, and documented all test results.

U.S. Navy: As Sonar Technician First Class (rank of E-6), supervised maintenance of the sonar system and coordinated divisional training. Performed troubleshooting of sonar system and equipment.



JOHN MOUNTEER
Engineer/Analyst IV

Education & Certifications

Marine Engineer License (Coast Guard),
Calhoun Marine Engineering School,
Baltimore, MD
Earned Cisco Certified Network Associate
(CCNA) and Design Associate (CCDA),
Checkpoint Certified Security
Administrator (CCSA), and Convergence
Technologies Professional (CTP)
certifications



Background

John has more than 25 years of experience in the IT fields of networking, voice and data systems, and policies and procedures, in the areas of design, operations and procurement. He has experience with managing and advising on numerous systems, network, data center, and related projects, for business, state government, local government, and education customers. A few examples of telecommunications related projects are included below.

Professional and Industry Experience

NYC Housing Preservation and Development (HPD) - Advised HPD on options for Voice system improvements, including upgrades and replacements with VoIP systems, including business and technical requirements review, budgetary estimates and recommendations for solutions

Averill Park Central School District -- Reviewed existing voice and data network infrastructure and made recommendations for improvements including options for voice system upgrades.

Northeast Regional Information Center (NERIC) - Reviewed voice system service offering, created on-line survey for customers, and made recommendations for improvements. Assisted with creation of a Request for Information for voice over IP systems.

City University of New York (CUNY) - Assisted CUNY in improving the availability and use of video collaboration tools. Included an on-line survey of users, recommendations for standards and infrastructure improvements to support video.

New York State Teachers Retirement System (NYSTRS) - technical advisor on a project team that analyzed NYSTRS' communication environment and recommended solutions to meet NYSTRS' current and future needs. Features considered included a backup call center and virtual agents. NYSTEC led in writing the RFP requirements, traceability matrix and evaluation plan and assisted NYSTRS in the vendor Q&A process as well as in RFP response evaluation.

NYS Office for Technology - Provided technical advice, project management, procurement expertise, and telecommunications expertise for OFT's Voice-over-Internet-Protocol (VoIP)/IP Telephony (IPT) services Request for Proposals (RFP). John was involved in all aspects of the procurement process including: detailed requirements gathering and recommendations; requirements prioritization; Request for Information (RFI) development; and RFP development. A detailed cost response workbook was developed to allow comparison of Total Cost of Ownership of hosted and premise based solutions. Additionally, John assisted with developing evaluation criteria and drafting an "Evaluation Plan" that defined how the evaluation would be conducted.

<p>NYS Workers Compensation Board - Gathered requirements, assisted RFP development and vendor evaluation for Call Center Quality Monitoring and call recording software for the NYS Workers' Compensation Board</p> <p>Other Related Experience</p> <p>Data Center Installation - managed the installation of regional data centers and remote office computer rooms from Montpelier, VT, to Dallas, TX for a national insurance company. Installed IBM servers, cluster controllers, token ring bridges, and Multiple Access Units (MAUs). Coordinated activities of wiring contractors and WAN service vendors.</p> <p>Engineering Support - provided engineering support as part of a geographically dispersed sales team for several of upstate New York's largest businesses, such as Kodak, MONY, National Grid, and Corning. Supported sales reps across upstate New York and New England. Examples of products sold: multiple wide-area network (WAN) technologies such as frame relay and internet Virtual Private Network (VPN), Voice over Internet Protocol (VoIP), managed network services (MNS), customer-premise equipment (CPE, e.g., routers), and security products such as firewalls and intrusion-detection systems.</p> <p>PBX Administration - Administered and managed enterprise phone systems (PBX), call management systems and interactive voice response units for large call centers and smaller regional claims and service offices for a national insurance company</p> <p>Call Center Training - trained call-center supervisors on agent phone features, on how to interpret call-management system (CMS) reports, and on creating custom reports. For customer service supervisors, wrote a handbook that was used company wide.</p> <p>Proposal Support - answered technical questions and wrote design solutions for RFP responses. Examples of proposal responses include WAN; Pass and Seymour WAN; Penn Traffic WAN and Managed Network Services; NY State Local Access (WAN); America's Job Bank WAN, and Crouse Hinds Firewall/VPN.</p> <p>Solution Design and Presentation - designed and presented solutions to customers in formal and informal settings using tools such as PowerPoint and Visio.</p> <p>Network Troubleshooting - performed network troubleshooting for established accounts. This included pulling and interpreting reports from various systems and accessing network switches and routers to check for proper configuration.</p>	
--	--



	<p>Technical Skills</p> <p>Develop project plans using MS Project.</p> <p>Develop requirements traceability matrix documents, evaluation scoring workbooks and pricing and Total Cost of Ownership (TCO) workbooks for RFPs.</p> <p>Data center rack layouts, voice and data network design using Visio and NetZoom</p> <p>Wired and wireless, voice and data network discovery and performance and security assessment using tools such as Solarwinds Engineers Toolkit, PRTG, Wireshark, Nessus, Airmagnet, IP Traffic Test and Measure</p> <p>Create online surveys for requirements and inventory collection using SurveyMonkey</p>
--	--

**Contract
Administration**

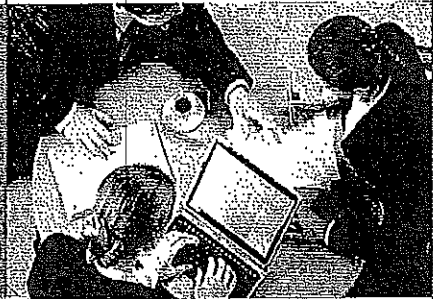



4 CONTRACT ADMINISTRATION

4.1 TERMS AND CONDITIONS

To be determined after discussions with the Jersey City Fire Department.

4.2 PAYMENT SCHEDULE

The Jersey City Fire Department is the designated entity responsible for payment and the administration of this contract.

- The JCFD agrees to make payments under this Agreement for the effort expended in performing the Project upon submission of the milestones in accordance with the project budget contained in this proposal.
- NYSTEC shall submit each request for payment to the JCFD and the JCFD shall submit each payment, within thirty (30) days of receipt of each invoice, to NYSTEC at the

Attn: Accounts Payable

NYSTEC

500 Avery Lane, Suite A

Rome, NY 13441



4.3 CONTRACT SIGNATURE PAGE

Period of Performance: April 21, 2014 – September 30, 2014
Authorized Amount: \$24,943.00

This is an AGREEMENT between the Jersey City Fire Department located at 425 Marin Boulevard, Jersey City, NJ 07302, and NYSTEC, located at 500 Avery Lane, Suite A, Rome, New York 13441, , which incorporates the attached Proposal No. 947TA.

IN WITNESS THEREOF, the parties hereto have executed this AGREEMENT as of the dates appearing after their signatures:

By: NYSTEC

By: Jersey City Fire Department

Signature

Signature

Jana S. Behe

Name

General Counsel & CCO

Title

Date

Date

Resolution of the City of Jersey City, N.J.

City Clerk File No. Res. 14.490
Agenda No. 10.W
Approved: JUL 16 2014



TITLE:

RESOLUTION AUTHORIZING AWARD OF A CONTRACT TO EXTEL COMMUNICATIONS INC. FOR VOICE AND DATA CABLING SYSTEMS UNDER STATE CONTRACT FOR DEPARTMENT OF PUBLIC WORKS, ESU FACILITY

COUNCIL OFFERED AND MOVED ADOPTION OF THE FOLLOWING RESOLUTION:

WHEREAS, Voice/Data Cabling Goods and Services are needed for the Emergency Services Unit (E.S.U.) located in the Department of Public Works Municipal Services Complex; and

WHEREAS, N.J.S.A. 40A:11-12. of the Local Public Contracts Law authorizes municipalities to use a State Contract and N.J.A.C. 5:34-7.29 requires City Council authorization for contracts exceeding \$36,000.00; and

WHEREAS, Extel Communications Inc. 830 Belmont Avenue, North Haledon, New Jersey 07508 is in possession of State Contract No. A80807, submitted a proposal for Voice and Data Cabling Systems; and

WHEREAS, funds are available for this contract in Administration's Capital Account Fund;

Account	P.O. #	State Contract	Total Contract
04-215-55-886-990	114046	A80807	\$38,575.00

WHEREAS, the City Purchasing Agent has certified that he considers said proposal to be fair and reasonable; and

NOW, THEREFORE, BE IT RESOLVED, by the Municipal Council of the City of Jersey City that the said proposal of the aforementioned Extel Communications Inc., be accepted and that a contract be awarded to said company in the above amount, and the Director of Purchasing is directed to have such a contract drawn up and executed; and be it further

RESOLVED, this contract shall be subject to the condition that the vendor/contractor provide satisfactory evidence of compliance with the Affirmative Action Amendments to the Law Against Discrimination, N.J.S.A. 10:5-31 et. seq.; and be it further

RESOLVED, that upon certification by an official or employee of the City authorized to receive the material pursuant to the contract, that the same has been received and that the requirements of the contract met, then; payment to the contractor shall be made in accordance with the provisions of the Local Fiscal Affairs Law, N.J.S.A. 40A:5-1 et. seq; and be it further

RESOLVED, that the Mayor or Business Administrator is hereby authorized to execute a contract on behalf of the City of Jersey City.

(Continued to page 2)

City Clerk File No. Res. 14.490

Agenda No. 10-W JUL 16 2014

TITLE:

RESOLUTION AUTHORIZING AWARD OF A CONTRACT TO EXTEL COMMUNICATIONS INC. FOR VOICE AND DATA CABLING SYSTEMS UNDER STATE CONTRACT FOR DEPARTMENT OF PUBLIC WORKS, ESU FACILITY

I, Donna Mauer, Donna Mauer, Chief Financial Officer, certify that there are sufficient funds available for payment of this above resolution in account 04-215-55-886-990.

Account	P.O. #	State Contract	Total Contract
04-215-55-886-990	114046	A80807	\$38,575.00

Approved by Peter Folgado for: Peter Folgado, Director of Purchasing, RPPO, QPA Date 7.9.14

PF/pv
7/1/14

APPROVED: [Signature]
APPROVED: [Signature] Business Administrator
ASST

APPROVED AS TO LEGAL FORM
[Signature] Corporation Counsel
Certification Required
Not Required

APPROVED 9-0

RECORD OF COUNCIL VOTE ON FINAL PASSAGE 7.16.14											
COUNCILPERSON	AYE	NAY	N.V.	COUNCILPERSON	AYE	NAY	N.V.	COUNCILPERSON	AYE	NAY	N.V.
GAJEWSKI	✓			YUN	✓			RIVERA	✓		
RAMCHAL	✓			OSBORNE	✓			WATTERMAN	✓		
BOGGIANO	✓			COLEMAN	✓			LAVARRO, PRES.	✓		

✓ Indicates Vote

N.V.-Not Voting (Abstain)

Adopted at a meeting of the Municipal Council of the City of Jersey City N.J.

[Signature]
Rolando R. Lavarro, Jr., President of Council

[Signature]
Robert Byrne, City Clerk

RESOLUTION FACT SHEET - CONTRACT AWARD

This summary sheet is to be attached to the front of any resolution that is submitted for Council consideration. Incomplete or vague fact sheets will be returned with the resolution.

Full Title of Ordinance/Resolution

RESOLUTION AUTHORIZING AWARD OF A CONTRACT TO EXTEL COMMUNICATIONS INC. FOR VOICE AND DATA CABLING SYSTEMS UNDER STATE CONTRACT FOR DEPARTMENT OF PUBLIC WORKS, ESU FACILITY

Project Manager

Department/Division	Administration	Information Technology
Name/Title	Robert Magro	Director
Phone/email	201-547-4274	bobm@cnj.org

Note: Project Manager must be available by phone during agenda meeting (Wednesday prior to council meeting @ 4:00 p.m.)

Contract Purpose

THE POLICE ESU FACILITY AT THE NEW MUNICIPAL SERVICE COMPLEX AT LINDEN AVE. REQUIRES ADDITIONAL VOICE/DATA CABLING TO PERFORM IT'S FUNCTIONS.

Cost (Identify all sources and amounts)

\$38,575.00

Contract term (include all proposed renewals)

**END UPON COMPLETION OF INSTALL
(ESTIMATED 3 MONTHS)**

Type of award

STATE CONTRACT

If "Other Exception", enter type

Additional Information

I certify that all the facts presented herein are accurate.

Signature of Department Director

7-9-14
Date

Signature of Director of Purchasing

Date



New Jersey Division of Revenue

Revenue

NJBGS

On-Line Business Registration Certificate Service

CERTIFICATE NUMBER 0102634 FOR EXTEL COMMUNICATIONS, INC. IS
VALID.

EXTEL Communications, Inc.

830 Belmont Ave.

North Haledon NJ 07508

QUOTE: JERSEY CITY ESU NEW BUILDING

DATE: 5/9/14

LABOR AND MATERIAL PRICING

DESCRIPTION	COST
<p>INSTALL 20 QUAD CAT 6 LOCATIONS AS PER DRAWING AND BOX LOCATIONS AT SITE LOCATION.</p>	
<p>INSTALL 13 SINGLE CAT 6 LOCATIONS FOR WALL PHONES.</p>	
<p>INSTALL STAINLESS STEEL FACEPLATES FOR ALL DROP LOCATIONS.</p>	
<p>INSTALL APPROX 200' OF 3/4" EMT CONDUIT PIPE WITH BOX FOR DROP LOCATIONS THAT DON'T HAVE BOXES INSTALLED FOR WALL PHONES AND QUAD LOCATIONS.</p>	
<p>INSTALL 7' RACK SYSTEM IN IT CLOSET WITH 2 48 PORT CAT 6 PATCH PANELS, 3 1U WIRE MANAGERS AND CABLE TRAY IF NEEDED.</p>	
<p>GROUND RACK WITH #6 GROUND WIRE AS PER CODE.</p>	
<p>INSTALL J HOOKS AND CABLE SUPPORTS WHERE NEEDED.</p>	
<p>TERMINATE, LABEL, TEST AND CERTIFY ALL CAT 6 DROPS TO STANDARDS.</p>	
<p>PRICING BASED ON UNION PW RATES THAT APPLY.</p>	
DATE _____	
SIGNATURE _____	
TOTAL COSTS	\$38,575.00

Governor Chris Christie • Lt. Governor Kim Guadagno



State of New Jersey
Department of the Treasury
Division of Purchase and Property

Search

[NJ Home](#) | [Services A to Z](#) | [Departments/Agencies](#) | [FAQs](#)

TERM CONTRACT SEARCH BY TNUMBER

[Click Here](#) to search more Term Contracts

T-Number	Title	Vendor	Contract #
T1316 11-x-21415	TELECOMMUNICATIONS EQUIPMENT & SERVICES	EXTEL COMMUNICATIONS INC	80807
			TOP



OPRA | Open Public Records Act

[Contact Us](#) | [Privacy Notice](#) | [Legal Statement](#) | [Accessibility Statement](#)



Purchase & Property: [Home](#) | [News](#) | [Directions](#) | [Frequently Asked Questions](#) | [Contact DPP](#)
Treasury: [Home](#) | [Services](#) | [People](#) | [Businesses](#) | [Departments/Agencies](#) | [Forms](#) | [Contact Us](#)
Statewide: [NJ Home](#) | [Services A to Z](#) | [Departments/Agencies](#) | [FAQs](#)
Copyright © State of New Jersey, 1996-2007
This site is maintained by the Division of Revenue and Enterprise Services.

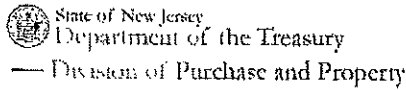

**Notice of Award
Term Contract(s)**

**T-1316
TELECOMMUNICATIONS EQUIPMENT & SERVICES**

Vendor Information
Authorized Dealers
By Vendor
RFP Documents
Email to JAMES E STRYPE

Downloadable NOA Documents
(Please utilize scroll bar on right side of box if necessary to view all documents)

[Download All Documents](#)

- [State Contract Manager Adobe PDF \(8 kb\)](#)
- [Method of Operation Adobe PDF \(54 kb\)](#)
- [Vendor Pricing Link](#)
- [Amendment #1 - Additional Distributors Adobe PDF \(19 kb\)](#)
- [Amendment #2 - Additional Distributors Adobe PDF \(21 kb\)](#)
- [Amendment #3 - Additional Distributors Adobe PDF \(19 kb\)](#)
- [Amendment #4 - Additional Distributors Adobe PDF \(17 kb\)](#)
- [Amendment #5 - Additional Distributors Adobe PDF \(21 kb\)](#)
- [Amendment #6 - Additional Distributors Adobe PDF \(21 kb\)](#)
- [Amendment #7 - Additional Distributors Adobe PDF](#)

The **Download All Documents** hyperlink will place compressed files on your computer. Files may be unzipped and viewed using WinZip. The evaluation version is available for free. [Click here](#) to learn more about WinZip or to download the latest version from the WinZip web site.

Forms in this section are stored in Adobe Acrobat (PDF) format. PDF formatted documents appear the same as the original printed forms. To view and print these forms, you must have a PDF viewer which is available free from Adobe. [Click here](#) to learn more about Adobe Acrobat or to download the latest version of the Adobe Acrobat viewer from the Adobe Web site.

NOAs By Number

NOAs By Title

Search NOAs

Index #:	T-1316
Contract #:	VARIOUS
Contract Period:	FROM: 02/01/12 TO: 01/31/17
Applicable To:	ALL STATE AGENCIES
Cooperative Purchasing:	POLITICAL SUBDIVISIONS*
Vendor Name & Address:	SEE VENDOR INFORMATION SECTION
For Procurement Bureau Use:	
Solicitation #:	21415
Bid Open Date:	01/06/11
CID #:	1038483

* WILL VENDOR EXTEND CONTRACT PRICES TO COOPERATIVE PURCHASING PARTICIPANTS?	
Vendor Name & Address:	AV BUSINESS COMMUNICATIONS LLC 200 W SOMERDALE RD/STE D - VOORHEES, NJ 08043
Contact Person:	GINNY NIMS
Contact Phone:	856-428-7227
Order Fax:	856-428-1717
Contract#:	80806
Expiration Date:	01/31/17
Terms:	1% 15 NET 30
Delivery:	10 DAYS ARO
Small Business Enterprise:	YES
Minority Business Enterprise:	NO
Women Business Enterprise:	YES
Cooperative Purchasing *:	YES
* WILL VENDOR EXTEND CONTRACT PRICES TO COOPERATIVE PURCHASING PARTICIPANTS?	
Vendor Name & Address:	AVAYA INC 161 CLIVEDEN DR NEWTOWN, PA 18940
Contact Person:	MICHAEL MCANDREWS
Contact Phone:	908-696-5587
Order Fax:	908-696-5587
Contract#:	80802
Expiration Date:	01/31/17
Terms:	NONE
Delivery:	SPECIFIED ELSEWHERE
Small Business Enterprise:	NO
Minority Business Enterprise:	NO
Women Business Enterprise:	NO
Cooperative Purchasing *:	YES
* WILL VENDOR EXTEND CONTRACT PRICES TO COOPERATIVE PURCHASING PARTICIPANTS?	
Vendor Name & Address:	DIRAD TECHNOLOGIES INC 9 CORPORATE DR CLIFTON PARK, NY 12065
Contact Person:	JOHN MICHNE
Contact Phone:	800-778-2927
Order Fax:	518-458-2782
Contract#:	80812
Expiration Date:	01/31/17
Terms:	NONE
Delivery:	SPECIFIED ELSEWHERE
Small Business Enterprise:	NO
Minority Business Enterprise:	NO
Women Business Enterprise:	NO
Cooperative Purchasing *:	YES
* WILL VENDOR EXTEND CONTRACT PRICES TO COOPERATIVE PURCHASING PARTICIPANTS?	
Vendor Name & Address:	EXTEL COMMUNICATIONS INC 830 BELMONT AVE NORTH HALEDON, NJ 07508
Contact Person:	THOMAS M RICHE
Contact Phone:	973-427-3900
Order Fax:	973-427-0008
Contract#:	80807
Expiration Date:	01/31/17
Terms:	NONE

Delivery:	10 DAYS ARO
Small Business Enterprise:	YES
Minority Business Enterprise:	NO
Women Business Enterprise:	NO
Cooperative Purchasing *:	YES
* WILL VENDOR EXTEND CONTRACT PRICES TO COOPERATIVE PURCHASING PARTICIPANTS?	
Vendor Name & Address:	MCI COMMUNICATIONS SRVCS INC ONE VERIZON WAY BASKING RIDGE, NJ 07920
Contact Person:	JIM LIVECCHI
Contact Phone:	609-915-4017
Order Fax:	000-000-0000
Contract#:	80813
Expiration Date:	01/31/17
Terms:	NONE
Delivery:	SPECIFIED ELSEWHERE
Small Business Enterprise:	NO
Minority Business Enterprise:	NO
Women Business Enterprise:	NO
Cooperative Purchasing *:	YES
* WILL VENDOR EXTEND CONTRACT PRICES TO COOPERATIVE PURCHASING PARTICIPANTS?	
Vendor Name & Address:	MITEL NETWORKS INC 1146 NORTH ALMA SCHOOL RD MESA, AZ 85201
Contact Person:	PETER COSME
Contact Phone:	312-479-9032
Order Fax:	312-479-9002
Contract#:	80805
Expiration Date:	01/31/17
Terms:	NONE
Delivery:	10 DAYS ARO
Small Business Enterprise:	NO
Minority Business Enterprise:	NO
Women Business Enterprise:	NO
Cooperative Purchasing *:	YES
* WILL VENDOR EXTEND CONTRACT PRICES TO COOPERATIVE PURCHASING PARTICIPANTS?	
Vendor Name & Address:	NEC CORPORATION OF AMERICA 6535 N STATE HIGHWAY 161 IRVING, TX 75039
Contact Person:	JAMES HARDIN
Contact Phone:	973-885-6915
Order Fax:	973-836-0432
Contract#:	80801
Expiration Date:	01/31/17
Terms:	NONE
Delivery:	SPECIFIED ELSEWHERE
Small Business Enterprise:	NO
Minority Business Enterprise:	NO
Women Business Enterprise:	NO
Cooperative Purchasing *:	YES
* WILL VENDOR EXTEND CONTRACT PRICES TO COOPERATIVE PURCHASING PARTICIPANTS?	
Vendor Name & Address:	OPTUS INC ACH-ELECTRONIC PAYMENTS P O BOX 2503 JONESBORO, AR 72402-2503
Contact Person:	JOSH BRADLEY

ITEM DESCRIPTION: INTERACTIVE VOICE RESPONSE (IVR) SERVICE - SCHEDULE O DELIVERY: 10 DAYS ARO					
Vendor: EXTEL COMMUNICATIONS INC			Contract Number: 80807		
LINE#	DESCRIPTION/MFGR/BRAND	EST QUANTITY	UNIT	% DISCOUNT	UNIT PRICE
00014	COMM CODE: 939-72-057373 [EQUIPMENT MAINTENANCE AND REPAIR...] ITEM DESCRIPTION: SEI - MAINTENANCE, MOVES, CHANGES, UPGRADES AND ADD-ON TO EXISTING SYSTEMS. BRAND: SEI	1.000	LOT	NET	N/A
LINE#	DESCRIPTION/MFGR/BRAND	EST QUANTITY	UNIT	% DISCOUNT	UNIT PRICE
00016	COMM CODE: 939-72-057357 [EQUIPMENT MAINTENANCE AND REPAIR...] ITEM DESCRIPTION: TONE COMMANDER - MAINTENANCE, MOVES, CHANGES, UPGRADES AND ADD- ON TO EXISTING SYSTEMS, BRAND: TONE COMMANDER DELIVERY: 10 DAYS ARO	1.000	LOT	NET	N/A
LINE#	DESCRIPTION/MFGR/BRAND	EST QUANTITY	UNIT	% DISCOUNT	UNIT PRICE
00017	COMM CODE: 939-72-077348 [EQUIPMENT MAINTENANCE AND REPAIR...] ITEM DESCRIPTION: TOSHIBA -MAINTENANCE, MOVES, CHANGES, UPGRADES, ADD-ON TO EXISTING SYSTEMS BRAND: TOSHIBA DELIVERY: 10 DAYS ARO	1.000	LOT	NET	N/A
LINE#	DESCRIPTION/MFGR/BRAND	EST QUANTITY	UNIT	% DISCOUNT	UNIT PRICE
00020	COMM CODE: 725-95-077356 [RADIO COMMUNICATION, TELEPHONE, AND...] ITEM DESCRIPTION: REFURBISHMENT OF TELEPHONE SETS SCHEDULE N DELIVERY: 10 DAYS ARO	1.000	LOT	NET	N/A
LINE#	DESCRIPTION/MFGR/BRAND	EST QUANTITY	UNIT	% DISCOUNT	UNIT PRICE
00025	COMM CODE: 725-55-077350 [RADIO COMMUNICATION, TELEPHONE, AND...] ITEM DESCRIPTION: U P S - PRICING ON SCHEDULE F DELIVERY: 10 DAYS ARO	1.000	LOT	NET	N/A
LINE#	DESCRIPTION/MFGR/BRAND	EST QUANTITY	UNIT	% DISCOUNT	UNIT PRICE

00026	COMM CODE: 915-79-077352 [COMMUNICATIONS AND MEDIA RELATED...] ITEM DESCRIPTION: TECHNICAL SUPPORT SERVICE - SCHEDULE J DELIVERY: 10 DAYS ARO	1.000	HOUR	NET	N/A
LINE#	DESCRIPTION/MFGR/BRAND	EST QUANTITY	UNIT	% DISCOUNT	UNIT PRICE
00027	COMM CODE: 915-79-077353 [COMMUNICATIONS AND MEDIA RELATED...] ITEM DESCRIPTION: DEDICATED SERVICE TECHNICIAN -SCHEDULE K DELIVERY: 10 DAYS ARO	1.000	HOUR	NET	N/A
LINE#	DESCRIPTION/MFGR/BRAND	EST QUANTITY	UNIT	% DISCOUNT	UNIT PRICE
00028	COMM CODE: 915-79-077354 [COMMUNICATIONS AND MEDIA RELATED...] ITEM DESCRIPTION: TRAINING - SCHEDULE L DELIVERY: 10 DAYS ARO	1.000	HOUR	NET	N/A
LINE#	DESCRIPTION/MFGR/BRAND	EST QUANTITY	UNIT	% DISCOUNT	UNIT PRICE
00029	COMM CODE: 915-79-077355 [COMMUNICATIONS AND MEDIA RELATED...] ITEM DESCRIPTION: PROJECT ENGINEERING, PROJECT MANAGEMENT, SITE MANAGEMENT SERVICE - SCHEDULE M DELIVERY: 10 DAYS ARO	1.000	HOUR	NET	N/A
LINE#	DESCRIPTION/MFGR/BRAND	EST QUANTITY	UNIT	% DISCOUNT	UNIT PRICE
00030	COMM CODE: 915-79-077361 [COMMUNICATIONS AND MEDIA RELATED...] ITEM DESCRIPTION: POST-WARRANTY MAINTENANCE -ALL INCLUSIVE ON-SITE: SCHEDULE G DELIVERY: 10 DAYS ARO	1.000	LOT	NET	N/A
LINE#	DESCRIPTION/MFGR/BRAND	EST QUANTITY	UNIT	% DISCOUNT	UNIT PRICE
00031	COMM CODE: 915-79-077362 [COMMUNICATIONS AND MEDIA RELATED...] ITEM DESCRIPTION: POST-WARRANTY MAINTENANCE DEPOT SCHEDULE H DELIVERY: 10 DAYS ARO	1.000	LOT	NET	N/A
LINE#	DESCRIPTION/MFGR/BRAND	EST QUANTITY	UNIT	% DISCOUNT	UNIT PRICE
00032	COMM CODE: 915-79-077363 [COMMUNICATIONS AND MEDIA RELATED...] ITEM DESCRIPTION: POST-WARRANTY MAINTENANCE TIME &	1.000	LOT	NET	N/A

	MATERIAL ON-SITE - SCHEDULE I				
	DELIVERY: 10 DAYS ARO				
LINE#	DESCRIPTION/MFGR/BRAND	EST QUANTITY	UNIT	% DISCOUNT	UNIT PRICE
00034	COMM CODE: 936-84-079486 [EQUIPMENT MAINTENANCE AND REPAIR...] ITEM DESCRIPTION: HOURLY LABOR RATES - SCHEDULE X DELIVERY: 10 DAYS ARO	1.000	HOURLY	NET	N/A
Vendor: MCI COMMUNICATIONS SRVCS INC		Contract Number: 80813			
LINE#	DESCRIPTION/MFGR/BRAND	EST QUANTITY	UNIT	% DISCOUNT	UNIT PRICE
00021	COMM CODE: 915-79-077357 [COMMUNICATIONS AND MEDIA RELATED...] ITEM DESCRIPTION: INTERACTIVE VOICE RESPONSE (IVR) SERVICE - SCHEDULE O DELIVERY: 10 DAYS ARO	1.000	LOT	NET	N/A
LINE#	DESCRIPTION/MFGR/BRAND	EST QUANTITY	UNIT	% DISCOUNT	UNIT PRICE
00023	COMM CODE: 915-79-077359 [COMMUNICATIONS AND MEDIA RELATED...] ITEM DESCRIPTION: VOICE MAIL SERVICE - SCHEDULE Q DELIVERY: 10 DAYS ARO	1.000	LOT	NET	N/A
LINE#	DESCRIPTION/MFGR/BRAND	EST QUANTITY	UNIT	% DISCOUNT	UNIT PRICE
00024	COMM CODE: 915-79-077360 [COMMUNICATIONS AND MEDIA RELATED...] ITEM DESCRIPTION: TELECONFERENCING SERVICE - SCHEDULE R DELIVERY: 10 DAYS ARO	1.000	LOT	NET	N/A
LINE#	DESCRIPTION/MFGR/BRAND	EST QUANTITY	UNIT	% DISCOUNT	UNIT PRICE
00033	COMM CODE: 915-79-079485 [COMMUNICATIONS AND MEDIA RELATED...] ITEM DESCRIPTION: ACD SERVICE - SCHEDULE W DELIVERY: 10 DAYS ARO	1.000	LOT	NET	N/A
Vendor: MITEL NETWORKS INC		Contract Number: 80805			
LINE#	DESCRIPTION/MFGR/BRAND	EST QUANTITY	UNIT	% DISCOUNT	UNIT PRICE
00005	COMM CODE: 725-56-077345 [RADIO COMMUNICATION, TELEPHONE, AND...] ITEM DESCRIPTION: ANALOG TERMINAL EQUIPMENT - SCHEDULE E DELIVERY: 10 DAYS ARO	1.000	LOT	NET	N/A

Resolution of the City of Jersey City, N.J.

City Clerk File No. Res. 14.491

Agenda No. 10.X

Approved: JUL 16 2014

TITLE:



RESOLUTION AUTHORIZING AWARD OF A CONTRACT TO EXTEL COMMUNICATIONS INC. FOR VOICE AND DATA CABLING SYSTEMS UNDER STATE CONTRACT FOR DEPARTMENT OF PUBLIC WORKS

COUNCIL OFFERED AND MOVED ADOPTION OF THE FOLLOWING RESOLUTION:

WHEREAS, Telecommunications Cabling Goods and Services are needed for the Department of Public Works Municipal Services Complex; and

WHEREAS, N.J.S.A. 40A:11-12. of the Local Public Contracts Law authorizes municipalities to use a State Contract and **N.J.A.C. 5:34-7.29** requires City Council authorization for contracts exceeding \$36,000.00; and

WHEREAS, Extel Communications Inc. 830 Belmont Avenue, North Haledon, New Jersey 07508 is in possession of State Contract No. **A80807**, submitted a proposal for **Telecommunications Cabling Goods and Services**; and

WHEREAS, funds are available for this contract in Information Technology's Capital Account Fund;

Account	P.O. #	State Contract	Total Contract
04-215-55-886-990	114045	A80807	\$50,000.00

WHEREAS, the City Purchasing Agent has certified that he considers said proposal to be fair and reasonable; and

NOW, THEREFORE, BE IT RESOLVED, by the Municipal Council of the City of Jersey City that the said proposal of the aforementioned Extel Communications Inc., be accepted and that a contract be awarded to said company in the above amount, and the Director of Purchasing is directed to have such a contract drawn up and executed; and be it further

RESOLVED, that upon certification by an official or employee of the City authorized to receive the material pursuant to the contract, that the same has been received and that the requirements of the contract met, then; payment to the contractor shall be made in accordance with the provisions of the Local Fiscal Affairs Law, **N.J.S.A. 40A:5-1 et. seq**; and be it further

RESOLVED, that the Mayor or Business Administrator is hereby authorized to execute a contract on behalf of the City of Jersey City.

(Continued to page 2)

City Clerk File No. Res. 14.491
Agenda No. 10.X JUL 16 2014

TITLE:

RESOLUTION AUTHORIZING AWARD OF A CONTRACT TO EXTEL COMMUNICATIONS INC. FOR VOICE AND DATA CABLING SYSTEMS UNDER STATE CONTRACT FOR DEPARTMENT OF PUBLIC WORKS

I, Donna Mauer, Donna Mauer, Chief Financial Officer, certify that there are sufficient funds available for payment of this above resolution.

Account **P.O. #** **State Contract** **Total Contract**
04-215-55-886-990 114045 A80807 \$50,000.00

Approved by P. Vega for:
Peter Folgado, Director of Purchasing, QPA, RPPO

7.9.14
Date

PF/pv
7/1/14

APPROVED: _____

APPROVED AS TO LEGAL FORM

APPROVED: Sergio Carrasco
Business Administrator
AST

Corporation Counsel

Certification Required

Not Required

APPROVED 9-0

RECORD OF COUNCIL VOTE ON FINAL PASSAGE 7.16.14											
COUNCILPERSON	AYE	NAY	N.V.	COUNCILPERSON	AYE	NAY	N.V.	COUNCILPERSON	AYE	NAY	N.V.
GAJEWSKI	✓			YUN	✓			RIVERA	✓		
RAMCHAL	✓			OSBORNE	✓			WATTERMAN	✓		
BOGGIANO	✓			COLEMAN	✓			LAVARRO, PRES.	✓		

✓ Indicates Vote

N.V.-Not Voting (Abstain)

Adopted at a meeting of the Municipal Council of the City of Jersey City N.J.

AR
Rolando R. Lavarro, Jr., President of Council

Robert Byrne
Robert Byrne, City Clerk

RESOLUTION FACT SHEET - CONTRACT AWARD

This summary sheet is to be attached to the front of any resolution that is submitted for Council consideration. Incomplete or vague fact sheets will be returned with the resolution.

Full Title of Ordinance/Resolution

RESOLUTION AUTHORIZING AWARD OF A CONTRACT TO EXTEL COMMUNICATIONS INC. AS AN OPEN END CONTRACT FOR TELECOMMUNICATIONS CABLING GOODS AND SERVICES UNDER STATE CONTRACT FOR THE DEPARTMENT OF PUBLIC WORKS

Project Manager

Department/Division	Administration	Information Technology
Name/Title	Robert Magro	Director
Phone/email	201-547-4274	bobm@jcnj.org

Note: Project Manager must be available by phone during agenda meeting (Wednesday prior to council meeting @ 4:00 p.m.)

Contract Purpose

THE NEW MUNICIPAL SERVICE COMPLEX AT LINDEN AVE. REQUIRES ADDITIONAL VOICE/DATA CABLING TO ACCOMMODATE JCIA AND OTHER MUNICIPAL SERVICE STAFF.

Cost (Identify all sources and amounts)

\$50,000.00

Contract term (include all proposed renewals)

END UPON COMPLETION OF INSTALL (ESTIMATED 3 MONTHS)

Type of award

STATE CONTRACT

If "Other Exception", enter type

Additional Information

I certify that all the facts presented herein are accurate.

Signature of Department Director

7-9-14
Date

Signature of Director of Purchasing

Date



New Jersey Division of Revenue

Revenue NJBGS

**On-Line Business Registration Certificate
Service**

**CERTIFICATE NUMBER 0102634 FOR EXTEL COMMUNICATIONS, INC. IS
VALID.**

26
YEARS

extelcommunications.com
1987 - 2013



City of Jersey City
Proposal Worksheet
As per State Contract A80807

Technician Cost on site hours (normal) \$88.00 per hour
Emergency Hours \$132.00 per hour

Standard Cable rates (up to 150ft.)

Standard CAT5e..... \$200 per
Standard CAT6..... \$250 per
Standard Dual CAT5/CAT5..... \$270 per
Standard Dual CAT6/CAT6..... \$325 per

Agreed to as stated

Agreed to as stated

EXTEL Communications, Inc.

Date: _____

City of Jersey City

Date: _____

Governor Chris Christie • Lt. Governor Kim Guadagno



State of New Jersey
Department of the Treasury

Division of Purchase and Property

Search

[NJ Home](#) | [Services A to Z](#) | [Departments/Agencies](#) | [FAQs](#)

TERM CONTRACT SEARCH BY TNUMBER

[Click Here](#) to search more Term Contracts

T-Number	Title	Vendor	Contract #
T1316 11- X-21415	TELECOMMUNICATIONS EQUIPMENT & SERVICES	EXTEL COMMUNICATIONS INC	80807

[TOP](#)



Public Records Act

[Contact Us](#) | [Privacy Notice](#) | [Legal Statement](#) | [Accessibility Statement](#)

[Purchase & Property: Home](#) | [News](#) | [Directions](#) | [Frequently Asked Questions](#) | [Contact DPP](#)
[Treasury: Home](#) | [Services](#) | [People](#) | [Businesses](#) | [Departments/Agencies](#) | [Forms](#) | [Contact Us](#)
[Statewide: NJ Home](#) | [Services A to Z](#) | [Departments/Agencies](#) | [FAQs](#)
Copyright © State of New Jersey, 1996-2007
This site is maintained by the Division of Revenue and Enterprise Services.

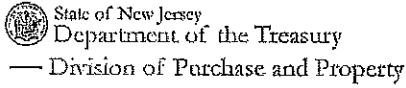

**Notice of Award
Term Contract(s)**

**T-1316
TELECOMMUNICATIONS EQUIPMENT & SERVICES**

Vendor Information
Authorized Dealers
By Vendor
RFP Documents
Email to JAMES E STRYPE

Downloadable NOA Documents
(Please utilize scroll bar on right side of box if necessary to view all documents)

[Download All Documents](#)

- [State Contract Manager Adobe PDF \(8 kb\)](#)
- [Method of Operation Adobe PDF \(54 kb\)](#)
- [Vendor Pricing Link](#)
- [Amendment #1 - Additional Distributors Adobe PDF \(19 kb\)](#)
- [Amendment #2 - Additional Distributors Adobe PDF \(21 kb\)](#)
- [Amendment #3 - Additional Distributors Adobe PDF \(19 kb\)](#)
- [Amendment #4 - Additional Distributors Adobe PDF \(17 kb\)](#)
- [Amendment #5 - Additional Distributors Adobe PDF \(21 kb\)](#)
- [Amendment #6 - Additional Distributors Adobe PDF \(21 kb\)](#)
- [Amendment #7 - Additional Distributors Adobe PDF](#)

The **Download All Documents** hyperlink will place compressed files on your computer. Files may be unzipped and viewed using WinZip. The evaluation version is available for free. [Click here](#) to learn more about WinZip or to download the latest version from the WinZip web site.

Forms in this section are stored in Adobe Acrobat (PDF) format. PDF formatted documents appear the same as the original printed forms. To view and print these forms, you must have a PDF viewer which is available free from Adobe. [Click here](#) to learn more about Adobe Acrobat or to download the latest version of the Adobe Acrobat viewer from the Adobe Web site.

NOAs By Number

NOAs By Title

Search NOAs

Index #:	T-1316
Contract #:	VARIOUS
Contract Period:	FROM: 02/01/12 TO: 01/31/17
Applicable To:	ALL STATE AGENCIES
Cooperative Purchasing:	POLITICAL SUBDIVISIONS*
Vendor Name & Address:	SEE VENDOR INFORMATION SECTION
For Procurement Bureau Use:	
Solicitation #:	21415
Bid Open Date:	01/06/11
CID #:	1038483

* WILL VENDOR EXTEND CONTRACT PRICES TO COOPERATIVE PURCHASING PARTICIPANTS?	
Vendor Name & Address:	AV BUSINESS COMMUNICATIONS LLC 200 W SOMERDALE RD/STE D VOORHEES, NJ 08043
Contact Person:	GINNY NIMS
Contact Phone:	856-428-7227
Order Fax:	856-428-1717
Contract#:	80806
Expiration Date:	01/31/17
Terms:	1% 15 NET 30
Delivery:	10 DAYS ARO
Small Business Enterprise:	YES
Minority Business Enterprise:	NO
Women Business Enterprise:	YES
Cooperative Purchasing *:	YES
* WILL VENDOR EXTEND CONTRACT PRICES TO COOPERATIVE PURCHASING PARTICIPANTS?	
Vendor Name & Address:	AVAYA INC 161 CLIVEDEN DR NEWTOWN, PA 18940
Contact Person:	MICHAEL MCANDREWS
Contact Phone:	908-696-5587
Order Fax:	908-696-5587
Contract#:	80802
Expiration Date:	01/31/17
Terms:	NONE
Delivery:	SPECIFIED ELSEWHERE
Small Business Enterprise:	NO
Minority Business Enterprise:	NO
Women Business Enterprise:	NO
Cooperative Purchasing *:	YES
* WILL VENDOR EXTEND CONTRACT PRICES TO COOPERATIVE PURCHASING PARTICIPANTS?	
Vendor Name & Address:	DIRAD TECHNOLOGIES INC 9 CORPORATE DR CLIFTON PARK, NY 12065
Contact Person:	JOHN MICHNE
Contact Phone:	800-778-2927
Order Fax:	518-458-2782
Contract#:	80812
Expiration Date:	01/31/17
Terms:	NONE
Delivery:	SPECIFIED ELSEWHERE
Small Business Enterprise:	NO
Minority Business Enterprise:	NO
Women Business Enterprise:	NO
Cooperative Purchasing *:	YES
* WILL VENDOR EXTEND CONTRACT PRICES TO COOPERATIVE PURCHASING PARTICIPANTS?	
Vendor Name & Address:	EXTEL COMMUNICATIONS INC 830 BELMONT AVE NORTH HALEDON, NJ 07508
Contact Person:	THOMAS M RICHE
Contact Phone:	973-427-3900
Order Fax:	973-427-0008
Contract#:	80807
Expiration Date:	01/31/17
Terms:	NONE

Delivery:	10 DAYS ARO
Small Business Enterprise:	YES
Minority Business Enterprise:	NO
Women Business Enterprise:	NO
Cooperative Purchasing *:	YES
* WILL VENDOR EXTEND CONTRACT PRICES TO COOPERATIVE PURCHASING PARTICIPANTS?	
Vendor Name & Address:	
	MCI COMMUNICATIONS SRVCS INC ONE VERIZON WAY BASKING RIDGE, NJ 07920
Contact Person:	JIM LIVECCHI
Contact Phone:	609-915-4017
Order Fax:	000-000-0000
Contract#:	80813
Expiration Date:	01/31/17
Terms:	NONE
Delivery:	SPECIFIED ELSEWHERE
Small Business Enterprise:	NO
Minority Business Enterprise:	NO
Women Business Enterprise:	NO
Cooperative Purchasing *:	YES
* WILL VENDOR EXTEND CONTRACT PRICES TO COOPERATIVE PURCHASING PARTICIPANTS?	
Vendor Name & Address:	
	MITEL NETWORKS INC 1146 NORTH ALMA SCHOOL RD MESA, AZ 85201
Contact Person:	PETER COSME
Contact Phone:	312-479-9032
Order Fax:	312-479-9002
Contract#:	80805
Expiration Date:	01/31/17
Terms:	NONE
Delivery:	10 DAYS ARO
Small Business Enterprise:	NO
Minority Business Enterprise:	NO
Women Business Enterprise:	NO
Cooperative Purchasing *:	YES
* WILL VENDOR EXTEND CONTRACT PRICES TO COOPERATIVE PURCHASING PARTICIPANTS?	
Vendor Name & Address:	
	NEC CORPORATION OF AMERICA 6535 N STATE HIGHWAY 161 IRVING, TX 75039
Contact Person:	JAMES HARDIN
Contact Phone:	973-885-6915
Order Fax:	973-836-0432
Contract#:	80801
Expiration Date:	01/31/17
Terms:	NONE
Delivery:	SPECIFIED ELSEWHERE
Small Business Enterprise:	NO
Minority Business Enterprise:	NO
Women Business Enterprise:	NO
Cooperative Purchasing *:	YES
* WILL VENDOR EXTEND CONTRACT PRICES TO COOPERATIVE PURCHASING PARTICIPANTS?	
Vendor Name & Address:	
	OPTUS INC ACH-ELECTRONIC PAYMENTS P O BOX 2503 JONESBORO, AR 72402-2503
Contact Person:	JOSH BRADLEY

ITEM DESCRIPTION: INTERACTIVE VOICE RESPONSE (IVR) SERVICE - SCHEDULE O DELIVERY: 10 DAYS ARO					
Vendor: EXTEL COMMUNICATIONS INC			Contract Number: 80807		
LINE#	DESCRIPTION/MFGR/BRAND	EST QUANTITY	UNIT	% DISCOUNT	UNIT PRICE
00014	COMM CODE: 939-72-057373 [EQUIPMENT MAINTENANCE AND REPAIR...] ITEM DESCRIPTION: SEI - MAINTENANCE, MOVES, CHANGES, UPGRADES AND ADD-ON TO EXISTING SYSTEMS. BRAND: SEI	1.000	LOT	NET	N/A
LINE#	DESCRIPTION/MFGR/BRAND	EST QUANTITY	UNIT	% DISCOUNT	UNIT PRICE
00016	COMM CODE: 939-72-057357 [EQUIPMENT MAINTENANCE AND REPAIR...] ITEM DESCRIPTION: TONE COMMANDER - MAINTENANCE, MOVES, CHANGES, UPGRADES AND ADD-ON TO EXISTING SYSTEMS, BRAND: TONE COMMANDER DELIVERY: 10 DAYS ARO	1.000	LOT	NET	N/A
LINE#	DESCRIPTION/MFGR/BRAND	EST QUANTITY	UNIT	% DISCOUNT	UNIT PRICE
00017	COMM CODE: 939-72-077348 [EQUIPMENT MAINTENANCE AND REPAIR...] ITEM DESCRIPTION: TOSHIBA - MAINTENANCE, MOVES, CHANGES, UPGRADES, ADD-ON TO EXISTING SYSTEMS BRAND: TOSHIBA DELIVERY: 10 DAYS ARO	1.000	LOT	NET	N/A
LINE#	DESCRIPTION/MFGR/BRAND	EST QUANTITY	UNIT	% DISCOUNT	UNIT PRICE
00020	COMM CODE: 725-95-077356 [RADIO COMMUNICATION, TELEPHONE, AND...] ITEM DESCRIPTION: REFURBISHMENT OF TELEPHONE SETS SCHEDULE N DELIVERY: 10 DAYS ARO	1.000	LOT	NET	N/A
LINE#	DESCRIPTION/MFGR/BRAND	EST QUANTITY	UNIT	% DISCOUNT	UNIT PRICE
00025	COMM CODE: 725-55-077350 [RADIO COMMUNICATION, TELEPHONE, AND...] ITEM DESCRIPTION: U P S - PRICING ON SCHEDULE F DELIVERY: 10 DAYS ARO	1.000	LOT	NET	N/A
LINE#	DESCRIPTION/MFGR/BRAND	EST QUANTITY	UNIT	% DISCOUNT	UNIT PRICE

00026	COMM CODE: 915-79-077352 [COMMUNICATIONS AND MEDIA RELATED...] ITEM DESCRIPTION: TECHNICAL SUPPORT SERVICE - SCHEDULE J DELIVERY: 10 DAYS ARO	1.000	HOUR	NET	N/A
LINE#	DESCRIPTION/MFGR/BRAND	EST QUANTITY	UNIT	% DISCOUNT	UNIT PRICE
00027	COMM CODE: 915-79-077353 [COMMUNICATIONS AND MEDIA RELATED...] ITEM DESCRIPTION: DEDICATED SERVICE TECHNICIAN - SCHEDULE K DELIVERY: 10 DAYS ARO	1.000	HOUR	NET	N/A
LINE#	DESCRIPTION/MFGR/BRAND	EST QUANTITY	UNIT	% DISCOUNT	UNIT PRICE
00028	COMM CODE: 915-79-077354 [COMMUNICATIONS AND MEDIA RELATED...] ITEM DESCRIPTION: TRAINING - SCHEDULE L DELIVERY: 10 DAYS ARO	1.000	HOUR	NET	N/A
LINE#	DESCRIPTION/MFGR/BRAND	EST QUANTITY	UNIT	% DISCOUNT	UNIT PRICE
00029	COMM CODE: 915-79-077355 [COMMUNICATIONS AND MEDIA RELATED...] ITEM DESCRIPTION: PROJECT ENGINEERING, PROJECT MANAGEMENT, SITE MANAGEMENT SERVICE - SCHEDULE M DELIVERY: 10 DAYS ARO	1.000	HOUR	NET	N/A
LINE#	DESCRIPTION/MFGR/BRAND	EST QUANTITY	UNIT	% DISCOUNT	UNIT PRICE
00030	COMM CODE: 915-79-077361 [COMMUNICATIONS AND MEDIA RELATED...] ITEM DESCRIPTION: POST-WARRANTY MAINTENANCE -ALL INCLUSIVE ON-SITE: SCHEDULE G DELIVERY: 10 DAYS ARO	1.000	LOT	NET	N/A
LINE#	DESCRIPTION/MFGR/BRAND	EST QUANTITY	UNIT	% DISCOUNT	UNIT PRICE
00031	COMM CODE: 915-79-077362 [COMMUNICATIONS AND MEDIA RELATED...] ITEM DESCRIPTION: POST-WARRANTY MAINTENANCE DEPOT SCHEDULE H DELIVERY: 10 DAYS ARO	1.000	LOT	NET	N/A
LINE#	DESCRIPTION/MFGR/BRAND	EST QUANTITY	UNIT	% DISCOUNT	UNIT PRICE
00032	COMM CODE: 915-79-077363 [COMMUNICATIONS AND MEDIA RELATED...] ITEM DESCRIPTION: POST-WARRANTY MAINTENANCE TIME &	1.000	LOT	NET	N/A

	MATERIAL ON-SITE - SCHEDULE I				
	DELIVERY: 10 DAYS ARO				
LINE#	DESCRIPTION/MFGR/BRAND	EST QUANTITY	UNIT	% DISCOUNT	UNIT PRICE
00034	COMM CODE: 936-84-079486 [EQUIPMENT MAINTENANCE AND REPAIR...] ITEM DESCRIPTION: HOURLY LABOR RATES - SCHEDULE X DELIVERY: 10 DAYS ARO	1.000	HOUR	NET	N/A
Vendor: MCI COMMUNICATIONS SRVCS INC		Contract Number: 80813			
LINE#	DESCRIPTION/MFGR/BRAND	EST QUANTITY	UNIT	% DISCOUNT	UNIT PRICE
00021	COMM CODE: 915-79-077357 [COMMUNICATIONS AND MEDIA RELATED...] ITEM DESCRIPTION: INTERACTIVE VOICE RESPONSE (IVR) SERVICE - SCHEDULE O DELIVERY: 10 DAYS ARO	1.000	LOT	NET	N/A
LINE#	DESCRIPTION/MFGR/BRAND	EST QUANTITY	UNIT	% DISCOUNT	UNIT PRICE
00023	COMM CODE: 915-79-077359 [COMMUNICATIONS AND MEDIA RELATED...] ITEM DESCRIPTION: VOICE MAIL SERVICE - SCHEDULE Q DELIVERY: 10 DAYS ARO	1.000	LOT	NET	N/A
LINE#	DESCRIPTION/MFGR/BRAND	EST QUANTITY	UNIT	% DISCOUNT	UNIT PRICE
00024	COMM CODE: 915-79-077360 [COMMUNICATIONS AND MEDIA RELATED...] ITEM DESCRIPTION: TELECONFERENCING SERVICE - SCHEDULE R DELIVERY: 10 DAYS ARO	1.000	LOT	NET	N/A
LINE#	DESCRIPTION/MFGR/BRAND	EST QUANTITY	UNIT	% DISCOUNT	UNIT PRICE
00033	COMM CODE: 915-79-079485 [COMMUNICATIONS AND MEDIA RELATED...] ITEM DESCRIPTION: ACD SERVICE - SCHEDULE W DELIVERY: 10 DAYS ARO	1.000	LOT	NET	N/A
Vendor: MITEL NETWORKS INC		Contract Number: 80805			
LINE#	DESCRIPTION/MFGR/BRAND	EST QUANTITY	UNIT	% DISCOUNT	UNIT PRICE
00005	COMM CODE: 725-56-077345 [RADIO COMMUNICATION, TELEPHONE, AND...] ITEM DESCRIPTION: ANALOG TERMINAL EQUIPMENT - SCHEDULE E DELIVERY: 10 DAYS ARO	1.000	LOT	NET	N/A

Resolution of the City of Jersey City, N.J.

City Clerk File No. Res. 14.492

Agenda No. 10.Y

Approved: JUL 16 2014

TITLE:



RESOLUTION AUTHORIZING THE AWARD OF AN OPEN-END CONTRACT TO WB MASON TO SUPPLY AND DELIVER CUSTODIAL PAPER PRODUCTS FOR THE DEPARTMENT OF PUBLIC WORKS/DIVISION OF BUILDINGS AND STREET MAINTENANCE

COUNCIL

offered and moved adoption of the following Resolution:

WHEREAS, the City of Jersey City advertised for the receipt of bids on June 24, 2014 to Supply and Deliver Custodial Paper Products for the Department of Public Works/ Division of Buildings and Street Maintenance ; and

WHEREAS, this contract was bid as a one-year (1) open-end contract with the following minimum and maximum quantities specified:

		<u>Minimum</u>	<u>Maximum</u>
Item No. 1	Toilet Paper	0	700 Cases
Item No. 2	Paper Towels	0	800 Cases
Item No. 3	C – Fold Towels	0	80 Cases
Item No. 4	Facial Tissue	0	40 Cases

WHEREAS, WB MASON submitted the lowest bid on Item No. 1 with a unit cost of \$28.25 per case, on Item No. 2 with a unit cost of \$14.95 per case, on Item No. 3 with a unit cost of \$14.67 per case and on Item No. 4 with a unit cost of \$16.64 per case; and

WHEREAS, the Purchasing Agent certified that he considers the bid submitted by WB Mason to be fair and reasonable; and

WHEREAS, the sum of Ten Thousand (\$10,000.00) Dollars is available in **Buildings Operating Account No. 01-201-26-291-206**; and

WHEREAS, the balance of the contract funds will be made available as orders are placed.

NOW, THEREFORE, be it resolved by the Municipal Council of the City of Jersey City that:

1. The Mayor or Business Administrator is authorized to execute an agreement with WB Mason to Supply and Deliver Custodial Paper Products for the Department of Public Works/Division of Buildings and Street Maintenance;
2. This contract is awarded as a one-year (1) open-end contract on Item No. 1 with a unit cost of \$28.25 per case, on Item No. 2 with a unit cost of \$14.95 per case, on Item No. 3 with a unit cost of \$14.67 per case and on Item No. 4 with a unit cost of \$16.64 per case;
3. The City reserves the right to extend the contract for up to (2) two additional (1) one year terms pursuant to specifications and bids thereon;
4. The minimum quantity of Item No.1 – Toilet Paper ordered under the contract shall be 0 cases and the maximum quantity shall be 700 cases;
5. The minimum quantity of Item No.2 – Paper Towels ordered under the contract shall be 0 cases and the maximum quantity shall be 800 cases;

(continued on Page 2)

City Clerk File No. Res. 14.492

Agenda No. 10.Y JUL 16 2014

TITLE: RESOLUTION AUTHORIZING THE AWARD OF AN OPEN-END CONTRACT TO WB MASON TO SUPPLY AND DELIVER CUSTODIAL PAPER PRODUCTS FOR THE DEPARTMENT OF PUBLIC WORKS/DIVISION OF BUILDINGS AND STREET MAINTENANCE

- 6. The minimum quantity of Item No.3 – C-Fold Towels ordered under the contract shall be 0 cases and the maximum quantity shall be 80 cases;
- 7. The minimum quantity of Item No.4 – Facial Tissue ordered under the contract shall be 0 cases and the maximum quantity shall be 40 cases;
- 8. The Chief Financial Officer shall prepare and execute certificates of available funds as orders are made during the term of the contract;
- 9. Upon certification by an official or employee of the City authorized to attest that the contractor has complied with specifications in all respects, and the requirements of the contract met, then payment to the contractor shall be made in accordance with the provisions of the Local Fiscal Affairs Law, N.J.S.A. 40A:5-1 et seq.; and
- 10. The award of this contract shall be subject to the condition that the contractor provide satisfactory evidence of compliance with the Affirmative Action Amendments to the Law Against Discrimination, N.J.S.A. 10:5-31 et seq.

I, Donna Mauer (Donna Mauer), Chief Financial Officer, certify that there are sufficient funds available for the payment of the above resolution in Account shown below

Department of Public Works/Division of Buildings and Street Maintenance			
Acct #	P.O #	Temp. Encumb.	Amount
01-201-26-291-206	114064		\$10,000.00
TOTAL CONTRACT			\$33,574.20

Approved by [Signature] 7/16/14
Peter Folgado, Director of Purchasing, QPA

APPROVED: [Signature]

APPROVED AS TO LEGAL FORM

APPROVED: [Signature]
Business Administrator

[Signature]
Corporation Counsel

Certification Required

Not Required

APPROVED 9-0

RECORD OF COUNCIL VOTE ON FINAL PASSAGE 7.16.14											
COUNCILPERSON	AYE	NAY	N.V.	COUNCILPERSON	AYE	NAY	N.V.	COUNCILPERSON	AYE	NAY	N.V.
GAJEWSKI	✓			YUN	✓			RIVERA	✓		
RAMCHAL	✓			OSBORNE	✓			WATTERMAN	✓		
BOGGIANO	✓			COLEMAN	✓			LAVARRO, PRES.	✓		

✓ Indicates Vote

N.V.-Not Voting (Abstain)

Adopted at a meeting of the Municipal Council of the City of Jersey City N.J.

[Signature]
Rolando R. Lavarro, Jr., President of Council

[Signature]
Robert Byrne, City Clerk

RESOLUTION FACT SHEET - CONTRACT AWARD

This summary sheet is to be attached to the front of any resolution that is submitted for Council consideration. Incomplete or vague fact sheets will be returned with the resolution.

Full Title of Ordinance/Resolution

RESOLUTION AWARDING AN OPEN - END CONTRACT TO WB MASON TO SUPPLY AND DELIVER CUSTODIAL PAPER PRODUCTS FOR THE DEPARTMENT OF PUBLIC WORKS, DIVISION OF BUILDINGS AND STREET MAINTENANCE.

Project Manager

Department/Division	Public Works	Buildings and Street Maintenance
Name/Title	John McGrath	Director
Phone/email	201-547-4432	mcgrathj@jenj.org

Note: Project Manager must be available by phone during agenda meeting (Wednesday prior to council meeting @ 4:00 p.m.)

Awarding a contract for custodial paper products. This was a public bid and awarding resolution will be drafted by Purchasing Division.

Cost (Identify all sources and amounts)

Contract term (include all proposed renewals)

Buildings and Street Operating Account (01-201-26-291-206)

Total Contract Amount = \$33,574.20
Temp. Encumbrancy Amount = \$10,000.00

Option to renew for up to two (2) additional one (1) year terms.

Type of award **Public Bid**

If "Other Exception", enter type

Additional Information

Five (5) bid proposals were received:

- 1. WB Mason , Cranberry , NJ = \$33,574.20*
- 2. Allen Paper & Supply , Morristown, NJ= \$34,923.00*
- 3. Central Poly , Linden, NJ = \$37,420.66*
- 4. United Sales USA Group, Brooklyn, NY= \$39,650.00*
- 5. Interline Brands , Mount Laurel, NJ = \$54,314.80*

I certify that all the facts presented herein are accurate.

Signature of Department Director

6/30/14
Date



**CITY OF JERSEY CITY
DEPARTMENT OF PUBLIC WORKS**

PUBLIC WORKS COMPLEX | 575 ROUTE 440 | JERSEY CITY, NJ 07305
P: 201 547 4402 | F: 201 547 4803



STEVEN M. FULOP
MAYOR OF JERSEY CITY

MICHAEL E. RAZZOLI
DIRECTOR

MEMORANDUM

Date: June 30, 2014
To: Peter Folgado, Purchasing Director
From: Michael Razzoli , DPW Director
Subject: Recommendation Letter (Custodial Paper Products)

Please be advised, after a careful and thorough review of bids received for custodial paper products, I recommend that the contract be awarded to:

**WB MASON CO., INC.,
21 COMMERCE DRIVE
CRANBURY, NJ 08512**

Total contract Amount = \$33,574.20 Temporary Encumbrancy = \$10,000.00

Please proceed and utilize the following requisitions listed below. Kindly draft the awarding resolution for the July 16th Council meeting.

REQ #	ACCOUNT NUMBER	AMOUNT
0166403	01-201-26-291-206 (Buildings Operating Account)	\$10,000.00

Should you have any questions or need any additional justifications regarding this contract award, please do not hesitate to call my office at X 4400/01.

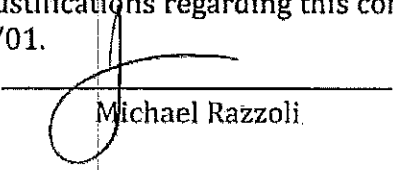
Michael Razzoli

C: Raquel Tosado, Contracts Manager
James Madden, DPW Deputy Director
John McGrath, Director, Buildings Maintenance
Hector Ortiz, Deputy Director of Operations
Bhavini Doshi, Confidential Aide, DPW Director's Office
Zakia Gregory, DPW Fiscal Office
Paola Campbell, Purchasing Division



**CITY OF JERSEY CITY
DEPARTMENT OF PUBLIC WORKS**

PUBLIC WORKS COMPLEX | 575 ROUTE 440 | JERSEY CITY, NJ 07305
P: 201 547 4402 | F: 201 547 4803



STEVEN M. FULOP
MAYOR OF JERSEY CITY

MICHAEL E. RAZZOLI
DIRECTOR

MEMORANDUM

Date: June 30, 2014

To: Rolando R. Lavarro, Jr; Council President and Members of the Municipal Council

From: John McGrath, Buildings Maintenance Director 

Subject: Contract Award (Custodial Paper Products)

There exists a need for custodial paper products. Five (5) proposals were received from:

1. WB Mason = \$33,574.20
2. Allen Paper & Supply = \$34,923.00
3. Central Poly = \$37,420.66
4. United Sales USA Group = \$39,650.00
5. Interline Brands = \$54,314.80

WB Mason, of 21 COMMERCE DRIVE, CRANBURY, NJ 08512 submitted the lowest proposal in the total bid amount of thirty three thousand five hundred and seventy four dollars and twenty cents (\$33,574.20).

The key point is that the City is making a contract based on the lowest unit cost for an item. The bid specification is an open – end contract. It indicated a minimum and maximum number of tons. If the maximum quantity is ordered by the City during the contract term, then the total cost of the contract would be \$33,574.20.

<u>ITEM</u>	<u>MINIMUM</u>	<u>MAXIMUM</u>	<u>UNIT PRICE / CASE</u>	<u>TOTAL</u>
Toilet Paper	0	700	\$28.25	\$19,775.00
Paper towels	0	800	\$14.95	\$11,960.00
C – Fold Towels	0	80	\$14.67	\$1,173.60
Facial Tissue	0	40	\$16.64	\$665.60
				\$33,574.20

The resolution is encumbering \$10,000.00 for now. As the year progresses, and if the City needs more than \$10,000.00 worth of paper products, additional funds are then encumbered through a change order under the authority of the contract award resolution.

CONTRACT FUNDING

Custodial Paper Products (Buildings Operating Account)

- ❖ Expenditure is drawn down from Buildings operating account, 01-201-28-375-206.
- ❖ Contract is utilizing object # 206.
- ❖ Line object 206 was budgeted for \$65,000.00 in CY 2014.
- ❖ As of today (06/30/14), \$19,681.91 has been spent in line object 206.
- ❖ This contract will lapse over two calendar years 2014 and 2015. Half of this contract will be from 2014 budget and other half will be budgeted in 2015 budget.
- ❖ To date, \$27,000.00 has been encumbered in object 206.

Should you have any questions/concerns or require further details regarding this matter, please do not hesitate to contact my office.

Thank you for your cooperation.

BID PROPOSAL/ DOCUMENTS
CUSTODIAL SUPPLIES SPECIFICATIONS
DPW/ DIVISION OF BUILDINGS & STREET MAINTENANCE

This contract will be awarded as an open- end contract. The minimum and the maximum number of quantities for each item are as stated below.

***Vendor must bid on the maximum number in column B

PAPER PRODUCTS

ITEM	***QUANTITY MINIMUM & MAXIMUM	DESCRIPTION	UNIT AMOUNT	EXTENDED AMOUNT (D X B)
A	B	C	D	
1.	0-700 Cases	Roll Toilet Paper (2 ply 500 sheets per roll), 96 rolls per case.	28.25	19,775.00
2.	0-800 Cases	Universal Hard Roll paper towels - 8 inch roll, 8" X 425 Ft; 12 rolls per case - Standard Dispenser (12 rolls per case)	14.95	11,960.00
3.	0-80 Cases	C - Fold towels - Natural White 10 1/4 X 13 sheet size, 150 per pk; 16 pkg. per case	14.67	1,173.60
4.	0-40 Cases	Facial Tissue - Flat Box - 150 Tissues 30 per case.	16.64	665.60

Note: This contract will be awarded as an open-end contract. The minimum and maximum number of quantities for each item are as stated. If zero is the minimum, the City is not obligated to order any quantities of that item during the contract term. If a specific number is stated for a minimum, then the City is obligated to purchase whatever that quantity is. Regardless of what the minimum quantity is set at, the vendor is still required to fill any order that the City places during the contract term until the maximum quantity is reached.

VENDOR MUST SUBMIT DETAIL INFORMATION REGARDING SUPPLIES THAT ARE EQUAL
TO ITEMS LISTED ON PAGE 1.

ITEM	MANUFACTURER NAME	PRODUCT NAME	CERTIFYING ORGANIZATION	CERTIFICATION ACHIEVED
1.	ATLAS 4.5' x 3.5' SHEET SIZE	ALMAS5 GREEN HERITAGE		
2.	SOFIDEL SOLD AS 8' x 350'	HEAVENLY SOFT HVN410095		
3.	LAGASSE	LAGGEN1510		
4.	MARCAL SOLD AS 100 SHEETS	MARCALPRO MRC2930		

NOTE: Vendor must provide a copy of Green Seal Certification for each quoted item. Certifications must be submitted in order for quoted items to be considered "green".

BID PROPOSAL / DOCUMENTS

GRAND TOTAL PRICE - ITEMS 1 THROUGH 4

The City will use the grand total price calculated by using the maximum quantities stated for items 1 through 4. The Supplier shall be paid on minimum and maximum quantities used; however, it shall not exceed the maximum quantity without prior issuance of a change order.

INCLUSIVE

~~THIRTY-THREE THOUSAND FIVE HUNDRED SEVENTY-FOUR DOLLARS AND
TWENTY CENTS~~
(In Writing)

\$ 33,574.20

(In Figures)

The contract will be awarded based upon the grand total price for items 1 through 4. If the Grand Total Price is found to have been incorrectly computed, changes will be made in any and all unit prices so as to attain conformity with the Grand Total Price before award is made.

Pursuant to N.J.S.A. 40A:11-15, the City shall have the option to renew the contract for up to two (2) additional one (1) year terms. The City shall notify the vendor whether or not it will be renewing the contract 45 days before the expiration date of the contract. If the City exercises its option to renew the contract, the vendor must accept the contract renewal. The renewal contract price shall be based upon the price of the original contract as cumulatively adjusted pursuant to any previous adjustment or extension and shall not exceed the change in the Index Rate for the twelve (12) months preceding the most recent quarterly calculation available at the time that the contract is renewed. The Index Rate means the rate of annual percentage increase, rounded to the nearest half-percent, in the Implicit Price Deflator for State and Local Government Purchases of Goods and Services, computed and Published quarterly by the United States Department of Commerce, Bureau of Economic Analysis.

EXHIBIT A (Continuation)

The contractor or subcontractor agrees to inform in writing its appropriate recruitment agencies including, but not limited to, employment agencies, placement bureaus, colleges, universities, and labor unions, that it does not discriminate on the basis of age, race, creed, color, national origin, ancestry, marital status, affectional or sexual orientation, gender identity or expression, disability, nationality or sex, and that it will discontinue the use of any recruitment agency which engages in direct or indirect discriminatory practices.

The contractor or subcontractor agrees to revise any of its testing procedures, if necessary, to assure that all personnel testing conforms with the principles of job-related testing, as established by the statutes and court decisions of the State of New Jersey and as established by applicable Federal law and applicable Federal court decisions.

In conforming with the targeted employment goals, the contractor or subcontractor agrees to review all procedures relating to transfer, upgrading, downgrading and layoff to ensure that all such actions are taken without regard to age, race, creed, color, national origin, ancestry, marital status, affectional or sexual orientation, gender identity or expression, disability, nationality or sex, consistent with the statutes and court decisions of the State of New Jersey, and applicable Federal law and applicable Federal court decisions.

The contractor shall submit to the public agency, after notification of award but prior to execution of a goods and services contract, one of the following three documents:

Letter of Federal Affirmative Action Plan Approval

Certificate of Employee Information Report

Employee Information Report Form AA302 (electronically provided by the Division and distributed to the public agency through the Division's website at www.state.nj.us/treasury/contract/compliance)

The contractor and its subcontractors shall furnish such reports or other documents to the Division of Purchase & Property, CCAU, EEO Monitoring Program as may be requested by the office from time to time in order to carry out the purposes of these regulations, and public agencies shall furnish such information as may be requested by the Division of Purchase & Property, CCAU, EEO Monitoring Program for conducting a compliance investigation pursuant to Subchapter 10 of the Administrative Code at N.J.A.C. 17:27.

The undersigned vendor certifies on their company's receipt, knowledge and commitment to comply with:

EXHIBIT A
N.J.S.A. 10:5-31 and N.J.A.C. 17:27
MANDATORY EQUAL EMPLOYMENT OPPORTUNITY LANGUAGE
Goods, Professional Services and General Service Contracts
(Mandatory Affirmative Action Language)

The undersigned vendor further agrees to furnish the required forms of evidence and

understands that their contract/company's bid shall be rejected as non-responsive if said contractor fails to comply with the requirements of N.J.S.A. 10:5-31 and N.J.A.C. 17:27.

Representative's Name/Title (Print): Daniel D. Jr., Senior V.P.

Representative's Signature: _____

Name of Company: W.B. Mason Co. Inc.

Tel. No.: 1-888-926-2766 Date: June 19, 2014

STATE OF NEW JERSEY DEPARTMENT OF THE TREASURY
 Division of Contract Compliance & Equal Employment Opportunity
 VENDOR ACTIVITY SUMMARY REPORT

NEW HIRES PROMOTIONS TRANSFERS TERMINATIONS (CHECK (X) APPROPRIATE ACTIVITY)

CERTIFICATE NO. _____ DATES OF PAYROLL PERIOD USED: FROM _____ TO _____
 NAME OF FACILITY: _____

W.B. Mason Co. Inc.
 Street City County State Zip Code

21 Commerce Drive, Cranbury, NJ 0852

JOB CATEGORIES	MALE						FEMALE					
	Total	Black	Hispanic	AM. Indian	Asian	Non-Min.	Total	Black	Hispanic	AM. Indian	Asian	Non-Min.
OFFICIALS & MANAGERS												
PROFESSIONALS												
TECHNICIANS												
SALES WORKERS												
OFFICE & CLERICAL												
CRAFTWORKERS												
OPERATIVES												
LABORERS												
SERVICE WORKERS												
TOTAL												

I certify that the information on this form is true and correct.
 NAME OF PERSON COMPLETING FORM (Print or Type) SIGNATURE DATE SUBMITTED
 LAST FIRST MI _____

ADDRESS (NO. & STREET) (CITY) (STATE) (ZIP) PHONE (AREA CODE, NO., EXTENSION)
21 Commerce Drive, Cranbury, NJ 08512 June 19, 2014
1-888-926-2766

APPENDIX A
AMERICANS WITH DISABILITIES ACT OF 1990
Equal Opportunity for Individuals with Disability

The contractor and the _____ of _____, (hereafter "owner") do hereby agree that the provisions of Title 11 of the Americans With Disabilities Act of 1990 (the "Act") (42 U.S.C. 5121 01 et seq.), which prohibits discrimination on the basis of disability by public entities in all services, programs, and activities provided or made available by public entities, and the rules and regulations promulgated pursuant thereto, are made a part of this contract. In providing any aid, benefit, or service on behalf of the owner pursuant to this contract, the contractor agrees that the performance shall be in strict compliance with the Act. In the event that the contractor, its agents, servants, employees, or subcontractors violate or are alleged to have violated the Act during the performance of this contract, the contractor shall defend the owner in any action or administrative proceeding commenced pursuant to this Act. The contractor shall indemnify, protect, and save harmless the owner, its agents, servants, and employees from and against any and all suits, claims, losses, demands, or damages, of whatever kind or nature arising out of or claimed to arise out of the alleged violation. The contractor shall, at its own expense, appear, defend, and pay any and all charges for legal services and any and all costs and other expenses arising from such action or administrative proceeding or incurred in connection therewith. In any and all complaints brought pursuant to the owner's grievance procedure, the contractor agrees to abide by any decision of the owner which is rendered pursuant to said grievance procedure. If any action or administrative proceeding results in an award of damages against the owner, or if the owner incurs any expense to cure a violation of the ADA which has been brought pursuant to its grievance procedure, the contractor shall satisfy and discharge the same at its own expense.

The owner shall, as soon as practicable after a claim has been made against it, give written notice thereof to the contractor along with full and complete particulars of the claim. If any action or administrative proceeding is brought against the owner or any of its agents, servants, and employees, the owner shall expeditiously forward or have forwarded to the contractor every demand, complaint, notice, summons, pleading, or other process received by the owner or its representatives.

It is expressly agreed and understood that any approval by the owner of the services provided by the contractor pursuant to this contract will not relieve the contractor of the obligation to comply with the Act and to defend, indemnify, protect, and save harmless the owner pursuant to this paragraph.

It is further agreed and understood that the owner assumes no obligation to indemnify or save harmless the contractor, its agents, servants, employees and subcontractors for any claim which may arise out of their performance of this Agreement. Furthermore, the contractor expressly understands and agrees that the provisions of this indemnification clause shall in no way limit the contractor's obligations assumed in this Agreement, nor shall they be construed to relieve the contractor from any liability, nor preclude the owner from taking any other actions available to it under any other provisions of the Agreement or otherwise at law.

Representative's Name/Title Print: Daniel J. Jr., Senior V.P.
Representative's Signature: _____
Name of Company: W. B. Mason Co. Inc.
Tel. No.: 1-888-926-2766 Date: June 19, 2014

**Minority/Woman Business Enterprise (MWBE)
Questionnaire for Bidders**

Jersey City Ordinance C-829 establishes a goal of awarding 20% of the dollar amount of total city procurement to minority and woman owned business enterprises.

To assist us in monitoring our achievement of this goal, please indicate below whether your company is or is not a minority owned and/or woman owned business, and return this form with your bid proposal.

Business Name : W. B. Mason Co. Inc.
Address : 21 Commerce Drive, Cranbury, NJ. 08512
Telephone No. : 1-888-926-2766
Contact Name : John Varga

Please check applicable category :

Minority Owned Business (MBE) Minority & Woman Owned Business (MWBE)
 Woman Owned business (WBE) Neither

**Definitions
Minority Business Enterprise**

Minority Business Enterprise means a business which is a sole proprietorship, partnership or corporation at least 51% of which is owned and controlled by persons who are African American, Hispanic, Asian American, American Indian or Alaskan native, defined as follows:

African American: a person having origins in any of the black racial groups of Africa

Hispanic: a person of Mexican, Puerto Rican, Central or South American or other non-European Spanish culture or origin regardless of race.

Asian: a person having origins in any of the original peoples of the Far East, South East Asia, Indian subcontinent, Hawaii or the Pacific Islands.

American Indian or Alaskan Native: a person having origins in any of the original peoples of North America and who maintains cultural identification through tribal affiliation or community recognition.

Woman Business Enterprise

Woman Business Enterprise means a business which is a sole proprietorship, partnership or corporation at least 51% of which is owned and controlled by a woman or women.

OFFICE OF EQUAL OPPORTUNITY COPY

Certification 28060

CERTIFICATE OF EMPLOYEE INFORMATION REPORT
RENEWAL

This is to certify that the contractor listed below has submitted an Employee Information Report pursuant to N.J.A.C. 17:27-1.1 et. seq. and the State Treasurer has approved said report. This approval will remain in effect for the period of 15 APR 2016 to 15 APR 2017



W.B. MASON COMPANY, INC.
59 CENTRE STREET
BROCKTON

MA 02301

A handwritten signature in black ink, appearing to read "Andrew P. Sidamon-Eristoff".

Andrew P. Sidamon-Eristoff
State Treasurer

State of New Jersey

Department of Labor and Workforce Development
Division of Wage and Hour Compliance

PUBLIC WORKS CONTRACTOR REGISTRATION ACT

Pursuant to N.J.S.A. 34:11-22.2(a), et seq. of the Public Works Contractor Registration Act, this certificate of registration is issued for the purposes of allowing an entry contract for public work or for registration in the participation of any public work for:

2014

Responsible Representative:
Eco Materials Corp
Thomas Robert Dwyer
James Robert Dwyer
Gregory Dwyer

Responsible Representative:

Responsible Representative:
Responsible Representative:
Responsible Representative:



STATE OF NEW JERSEY BUSINESS REGISTRATION CERTIFICATE

Taxpayer Name:	W B MASON CO INC
Trade Name:	
Address:	535 SECAUCUS RD SECAUCUS, NJ 07094
Certificate Number:	0056513
Effective Date:	January 10, 2000
Date of Issuance:	January 26, 2010

For Office Use Only:
20100126094240978



New Jersey Division of Revenue

Revenue NJBGS

On-Line Business Registration Certificate Service

CERTIFICATE NUMBER 0056513 FOR W B MASON CO INC IS VALID.

VERIFIED
PC

Resolution of the City of Jersey City, N.J.

City Clerk File No. Res. 14.493
Agenda No. 10.Z
Approved: JUL 16 2014
TITLE:



RESOLUTION AUTHORIZING THE AWARD OF AN OPEN-END CONTRACT TO ONLY ENTERPRISES TO SUPPLY AND DELIVER LARGE BLACK PLASTIC GARBAGE BAGS FOR THE DEPARTMENT OF PUBLIC WORKS/DIVISION OF PARKS MAINTENANCE

COUNCIL

offered and moved adoption of the following Resolution:

WHEREAS, the City of Jersey City advertised for the receipt of bids on May 6, 2014 to Supply and Deliver Large Black Plastic Garbage Bags for the Department of Public Works/ Division of Park Maintenance ; and

WHEREAS, this contract was bid as a one-year (1) open-end contract with the following minimum and maximum quantities specified:

		<u>Minimum</u>	<u>Maximum</u>
Item No. 1	38" X 39" – 3 mil	0	700 Cases
Item No 2	42" X 46" – 4 mil	0	900 Cases

WHEREAS, Orly Plastic Enterprises submitted the lowest bid on Item No. 1 with a unit cost of \$21.81 per case and Item No. 2 with a unit cost of \$35.00 per case; and

WHEREAS, the Purchasing Agent certified that he considers the bid submitted by Orly Plastic Enterprises to be fair and reasonable; and

WHEREAS, the sum of Ten Thousand (\$10,000.00) Dollars is available in **Parks Operating Account No. 01-201-28-375-206**; and

WHEREAS, the balance of the contract funds will be made available as orders are placed.

NOW, THEREFORE, be it resolved by the Municipal Council of the City of Jersey City that:

1. The Mayor or Business Administrator is authorized to execute an agreement with Orly Plastic Enterprises to Supply and Deliver Large Black Plastic Garbage Bags for the Department of Public Works/Division of Parks Maintenance;
2. This contract is awarded as a one-year (1) open-end contract on Item No. 1 with a unit cost of \$28.91 per case and Item No. 2 with a unit cost of \$35.00 per case;
3. The City reserves the right to extend the contract for up to (2) two additional (1) one year term pursuant to specifications and bids thereon;
4. The minimum quantity of Item No.1 - 38" X 39" – 3 mil ordered under the contract shall be 0 cases and the maximum quantity shall be 700 cases;
5. The minimum quantity of Item No.2 - 42" X 46" – 4 mil ordered under the contract shall be 0 cases and the maximum quantity shall be 900 cases;
6. The Chief Financial Officer shall prepare and execute certificates of available funds as orders are made during the term of the contract;

(continued on Page 2)

City Clerk File No. Res. 14.493
Agenda No. 10.Z JUL 16 2014

TITLE:

RESOLUTION AUTHORIZING THE AWARD OF AN OPEN-END CONTRACT TO ONLY ENTERPRISES TO SUPPLY AND DELIVER LARGE BLACK PLASTIC GARBAGE BAGS FOR THE DEPARTMENT OF PUBLIC WORKS/DIVISION OF PARKS MAINTENANCE

- 7. Upon certification by an official or employee of the City authorized to attest that the contractor has complied with specifications in all respects, and the requirements of the contract met, then payment to the contractor shall be made in accordance with the provisions of the Local Fiscal Affairs Law, N.J.S.A. 40A:5-1 et seq.; and
- 8. The award of this contract shall be subject to the condition that the contractor provide satisfactory evidence of compliance with the Affirmative Action Amendments to the Law Against Discrimination, N.J.S.A. 10:5-31 et seq.

I, Donna Mauer (Donna Mauer), Chief Financial Officer, certify that there are sufficient funds available for the payment of the above resolution in Account shown below

Department of Public Works/Division of Parks Maintenance			
Acct #	P.O #	Temp. Encumb.	Amount
01-201-28-375-206	113985		\$10,000.00
TOTAL CONTRACT			\$52,367.00

Approved by Peter Folgado, RPPS
Peter Folgado, Director of Purchasing, QPA

APPROVED: [Signature]
APPROVED: [Signature]
Business Administrator

APPROVED AS TO LEGAL FORM
[Signature]
Corporation Counsel
Certification Required
Not Required

APPROVED 9-0

RECORD OF COUNCIL VOTE ON FINAL PASSAGE 7.16.14											
COUNCILPERSON	AYE	NAY	N.V.	COUNCILPERSON	AYE	NAY	N.V.	COUNCILPERSON	AYE	NAY	N.V.
GAJEWSKI	✓			YUN	✓			RIVERA	✓		
RAMCHAL	✓			OSBORNE	✓			WATTERMAN	✓		
BOGGIANO	✓			COLEMAN	✓			LAVARRO, PRES.	✓		

✓ Indicates Vote

N.V.-Not Voting (Abstain)

Adopted at a meeting of the Municipal Council of the City of Jersey City N.J.

[Signature]
Rolando R. Lavarro, Jr., President of Council

[Signature]
Robert Byrne, City Clerk

RESOLUTION FACT SHEET - CONTRACT AWARD

This summary sheet is to be attached to the front of any resolution that is submitted for Council consideration. Incomplete or vague fact sheets will be returned with the resolution.

Full Title of Ordinance/Resolution

RESOLUTION AWARDING AN OPEN - END CONTRACT TO ORLY PLASTIC ENTERPRISES TO SUPPLY AND DELIVER LARGE BLACK PLASTIC BAGS FOR THE DEPARTMENT OF PUBLIC WORKS, DIVISION OF PARKS MAINTENANCE.

Project Manager

Department/Division	Public Works	Parks Maintenance
Name/Title	Cleveland Snow	Director
Phone/email	201-547-4495	csnow@icnj.org

Note: Project Manager must be available by phone during agenda meeting (Wednesday prior to council meeting @ 4:00 p.m.)

Awarding a contract for large black plastic bags. This was a public bid and awarding resolution will be drafted by Purchasing Division.

Cost (Identify all sources and amounts)

Contract term (include all proposed renewals)

Parks Operating Account (01-201-28-375-206)

Total Contract Amount = \$52,367.00
 Temp. Encumbrancy Amount = \$10,000.00

Option to renew for up to two (2) additional one (1) year terms.

Type of award **Public Bid**

If "Other Exception", enter type

Additional Information

Six (6) bid proposals were received:

1. Orly Industry = \$52,367.00
2. Interboro Packing = \$53,726.00
3. Central Poly = \$55,890.00
4. All American Poly = \$62,175.00
5. Pabeo Industries = \$65,109.00
6. DC Plastic Products = \$57,002.00 *** Rejected - No Bid Bond / Certified Check

I certify that all the facts presented herein are accurate.

Signature of Department Director

6/23/14
Date



STEVEN M. FULOP
MAYOR OF JERSEY CITY

CITY OF JERSEY CITY
DEPARTMENT OF PUBLIC WORKS

PUBLIC WORKS COMPLEX | 575 ROUTE 440 | JERSEY CITY, NJ 07305
P: 201 547 4402 | F: 201 547 4803



MICHAEL E. RAZZOLI
DIRECTOR

MEMORANDUM

Date: June 20, 2014
To: Peter Folgado, Purchasing Director
From: Michael Razzoli , DPW Director
Subject: Recommendation Letter (Large Black Plastic Bags)

Please be advised, after a careful and thorough review of bids received for Large Black Plastic Bags, I recommend that the contract be awarded to:

**ORLY PLASTIC ENTERPRISES
106 LEXINGTON AVENUE
BROOKLYN, NY 11238**

**Total contract Amount = \$52,367.00
Temporary Encumbrancy = \$10,000.00**

Please proceed and utilize the following requisitions listed below. Kindly draft the awarding resolution for the July 16th Council meeting.

REQ #	ACCOUNT NUMBER	AMOUNT
0166562	01-201-28-375-206 (Parks Operating Account)	\$10,000.00

Should you have any questions or need any additional justifications regarding this contract award, please do not hesitate to call my office at X 4400/01.

Michael Razzoli

- C: Raquel Tosado, Contracts Manager
James Madden, DPW Deputy Director
Cleveland Snow, Director, Parks Maintenance
Hector Ortiz, Deputy Director of Operations
Bhavini Doshi, Confidential Aide, DPW Director's Office

Zakia Gregory, DPW Fiscal Office
Paola Campbell, Purchasing Division
Yesenia Rivera, DPW Director's Office
Elizabeth Harley, Parks Maintenance



STEVEN M. FULOP
MAYOR OF JERSEY CITY

CITY OF JERSEY CITY
DEPARTMENT OF PUBLIC WORKS

PUBLIC WORKS COMPLEX | 575 ROUTE 440 | JERSEY CITY, NJ 07305
P: 201 547 4402 | F: 201 547 4803



MICHAEL E. RAZZOLI
DIRECTOR

MEMORANDUM

Date: June 20, 2014

To: Rolando R. Lavarro, Jr; Council President and Members of the Municipal Council

From: Cleveland Snow, Parks Maintenance Director *CS*

Subject : Contract Award (Large Black Plastic Bags)

There exists a need for large black plastic bags. Six (6) proposals were received, with the lowest responsible being that from Orly Plastic Enterprises, 106 Lexington Avenue, Brooklyn, NY11238 in the total bid amount of fifty two thousand three hundred and sixty seven dollars and zero cents (\$52,367.00). The other proposals were from:

- Interboro Packing = \$53,726.00
- Central Poly = \$55,890.00
- All American Poly = \$62,175.00
- Pabco Industries= \$65,109.00
- DC Plastic Products = \$57,002.00 *** Rejected - No Bid Bond / Certified Check

The key point is that the City is making a contract based on the lowest unit cost for an item. The bid specification is an open – end contract. It indicated a minimum and maximum number of bags. If the maximum quantity is ordered by the City during the contract term, then the total cost of the contract would be \$52,367.00.

ITEMS	MINIMUM	MAXIMUM	UNIT PRICE	TOTAL
38" X 59" – 3 mil	0	700	\$29.81	\$20,867.00
42" X 46" – 4 mil	0	900	\$35.00	\$31,500.00

The resolution is encumbering \$10,000.00 for now. As the year progresses, and if the City needs more than \$10,000.00 worth of bags, additional funds are then encumbered through a change order under the authority of the contract award resolution.

CONTRACT FUNDING

Large Black Plastic Bags (Parks Operating Account)

- ❖ Expenditure is drawn down from Parks operating account, 01-201-28-375-206.
- ❖ Contract is utilizing object # 206.
- ❖ Line object 206 was budgeted for \$60,000.00 in CY 2014.
- ❖ As of today (06/20/14), \$13,522.00 has been spent in line object 206.
- ❖ This contract will lapse over two calendar years 2014 and 2015. Half of this contract will be from 2014 budget and other half will be budgeted in 2015 budget.
- ❖ \$22,000.00 has been encumbered in object 206.

Should you have any questions/concerns or require further details regarding this matter, please do not hesitate to contact my office.

Thank you for your cooperation.



STEVEN M. FULOP
MAYOR OF JERSEY CITY

CITY OF JERSEY CITY
DEPARTMENT OF PUBLIC WORKS

PUBLIC WORKS COMPLEX | 575 ROUTE 440 | JERSEY CITY, NJ 07305
P: 201 547 4402 | F: 201 547 4803



MICHAEL E. RAZZOLI
DIRECTOR

MEMORANDUM

Date: June 17, 2014
From: Cleveland Snow, Director Division of Park Maintenance
To: Michael Razzoli, DPW Director
Subject: Recommendation Letter (Large Black Plastic Garbage Bags)

After reviewing the bids received in my office and my meeting with with Mr. Jacob Torkieh on June 12, 2014 from Orly Industry Inc. I recommend that the contract be award to:

Orly Industry Inc.
106 Lexington Avenue
Brooklyn, NY 11238
Contact person Mr. Jacob Torkieh, Owner
Tel-399-6311 Fax 718- 399-7175

See attached bid proposal from Orly Industry Inc.

Thank you

Cleveland Snow, Director
Division of Park Maintenance

DPW/FISCAL OFFICE
2014 JUN 19 P 3:19

c: James Madden, Deputy Director /DPW Director's Office
Silendra Bajnauth, Fiscal Officer/DPW Director's Office
Bhavini Doshi, Confidential Aide, DPW Director's Office

BID PROPOSAL/DOCUMENTS

LARGE BLACK PLASTIC GARBAGE BAGS SPECIFICATIONS
DPW/DIVISION OF PARK MAINTENANCE

This contract will be awarded as an open-end contract for a term of one year the minimum and the maximum number of quantities for each item or as stated below.

ITEM	QUANTITY MINIMUM & MAXIMUM	DESCRIPTION	Unit Amount	Extended Amount
1.	0 - 700 Cases	38" x 59" Large Black Plastic Garbage Bags 3 mil, flat bag seal, 100 bags per case, each case shall weigh no less than 40.36 lbs. Net weight. (TEEPEE OR APPROVED EQUAL)	29.81	20,867.
2.	0 - 900 Cases	42" x 46" Large Black Plastic Garbage Bags 4 mil, flat bag seal 100 bags per case, each case shall weigh no less than 46.37 lbs. Net weight (TEEPEE OR APPROVED EQUAL)	35.00	31,500

NOTE:

This contract will be awarded as an open-end contract. The minimum and maximum number of quantities for each item are as stated. If zero is the minimum, the City is not obligated to order any quantities of that item during the contract term. If a specific number is stated for a minimum, than the City is obligated to purchase whatever that quantity is. Regardless of what the minimum quantity is set at, the vendor is still required to fill any order that the City places during the contract term until the maximum quantity is reached.

BID PROPOSAL/DOCUMENTS

GRAND TOTAL ITEMS 1 AND 2

The City will use the grand total price calculated by using the sum of the unit amount times the extended amount for items 1 and 2. The Supplier shall be paid based on actual quantities used.

Fifty two thousand, three hundred sixty seven. dollars.
In Writing)

\$ 52,367.00
(In Figures)

This contract will be awarded based upon the grand total price for items 1 through 2. If the Grand total Price is found to have been incorrectly computed, changes will be made in any and all unit prices so as to attain conformity with the Grand Total Price before award is made.

Pursuant to N.J.S.A. 40A: 11-15, the City shall have the option to renew the contract for up to two additional one year terms. The City shall notify the vendor whether or not it will be renewing the contract 45 days before the expiration date of the contract. If the City exercises its option to renew the contract, the vendor must accept the contract renewal. Any price change included as part of a renewal shall be based upon the price of the original contract as cumulatively adjusted pursuant to any previous adjustment or extension and shall not exceed the change in the index rate for the twelve months preceding the most recent quarterly calculation available at the time the contract is renewed. Index rate means the rate of annual percentage increase, rounded to the nearest half-percent, in the Implicit Price Deflator for State and Local Government Purchases of Goods and Services, computed and published quarterly by the United States Department of Commerce, Bureau of Economic Analysis.

EXHIBIT A (Continuation)

The contractor or subcontractor agrees to inform in writing its appropriate recruitment agencies including, but not limited to, employment agencies, placement bureaus, colleges, universities, and labor unions, that it does not discriminate on the basis of age, race, creed, color, national origin, ancestry, marital status, affectional or sexual orientation, gender identity or expression, disability, nationality or sex, and that it will discontinue the use of any recruitment agency which engages in direct or indirect discriminatory practices.

The contractor or subcontractor agrees to revise any of its testing procedures, if necessary, to assure that all personnel testing conforms with the principles of job-related testing, as established by the statutes and court decisions of the State of New Jersey and as established by applicable Federal law and applicable Federal court decisions.

In conforming with the targeted employment goals, the contractor or subcontractor agrees to review all procedures relating to transfer, upgrading, downgrading and layoff to ensure that all such actions are taken without regard to age, race, creed, color, national origin, ancestry, marital status, affectional or sexual orientation, gender identity or expression, disability, nationality or sex, consistent with the statutes and court decisions of the State of New Jersey, and applicable Federal law and applicable Federal court decisions.

The contractor shall submit to the public agency, after notification of award but prior to execution of a goods and services contract, one of the following three documents:

Letter of Federal Affirmative Action Plan Approval

Certificate of Employee Information Report

Employee Information Report Form AA302 (electronically provided by the Division and distributed to the public agency through the Division's website at www.state.nj.us/treasury/contract_compliance)

The contractor and its subcontractors shall furnish such reports or other documents to the Division of Purchase & Property, CCAU, EEO Monitoring Program as may be requested by the office from time to time in order to carry out the purposes of these regulations, and public agencies shall furnish such information as may be requested by the Division of Purchase & Property, CCAU, EEO Monitoring Program for conducting a compliance investigation pursuant to Subchapter 10 of the Administrative Code at N.J.A.C. 17:27.

The undersigned vendor certifies on their company's receipt, knowledge and commitment to comply with:

EXHIBIT A
N.J.S.A. 10:5-31 and N.J.A.C. 17:27
MANDATORY EQUAL EMPLOYMENT OPPORTUNITY LANGUAGE
Goods, Professional Services and General Services Contracts
(Mandatory Affirmative Action Language)

The undersigned vendor further agrees to furnish the required forms of evidence and

understands that their contract/company's bid shall be rejected as non-responsive if said contractor fails to comply with the requirements of N.J.S.A. 10:5-31 and N.J.A.C. 17:27.

Representative's Name/Title (Print): JACOB TORKIEIT

Representative's Signature: 

Name of Company: ORLY INDUSTRY INC

Tel. No.: 418-399-6311 Date: 5/5/14

APPENDIX A
AMERICANS WITH DISABILITIES ACT OF 1990
Equal Opportunity for Individuals with Disability

The contractor and the _____ of _____ (hereafter "owner") do hereby agree that the provisions of Title 11 of the Americans With Disabilities Act of 1990 (the "Act") (42 U.S.C. 5121 01 et seq.), which prohibits discrimination on the basis of disability by public entities in all services, programs, and activities provided or made available by public entities, and the rules and regulations promulgated pursuant thereto, are made a part of this contract. In providing any aid, benefit, or service on behalf of the owner pursuant to this contract, the contractor agrees that the performance shall be in strict compliance with the Act. In the event that the contractor, its agents, servants, employees, or subcontractors violate or are alleged to have violated the Act during the performance of this contract, the contractor shall defend the owner in any action or administrative proceeding commenced pursuant to this Act. The contractor shall indemnify, protect, and save harmless the owner, its agents, servants, and employees from and against any and all suits, claims, losses, demands, or damages, of whatever kind or nature, arising out of or claimed to arise out of the alleged violation. The contractor shall, at its own expense, appear, defend, and pay any and all charges for legal services and any and all costs and other expenses arising from such action or administrative proceeding or incurred in connection therewith. In any and all complaints brought pursuant to the owner's grievance procedure, the contractor agrees to abide by any decision of the owner which is rendered pursuant to said grievance procedure. If any action or administrative proceeding results in an award of damages against the owner, or if the owner incurs any expense to cure a violation of the ADA which has been brought pursuant to its grievance procedure, the contractor shall satisfy and discharge the same at its own expense.

The owner shall, as soon as practicable after a claim has been made against it, give written notice thereof to the contractor along with full and complete particulars of the claim. If any action or administrative proceeding is brought against the owner or any of its agents, servants, and employees, the owner shall expeditiously forward or have forwarded to the contractor every demand, complaint, notice, summons, pleading, or other process received by the owner or its representatives.

It is expressly agreed and understood that any approval by the owner of the services provided by the contractor pursuant to this contract will not relieve the contractor of the obligation to comply with the Act and to defend, indemnify, protect, and save harmless the owner pursuant to this paragraph.

It is further agreed and understood that the owner assumes no obligation to indemnify or save harmless the contractor, its agents, servants, employees and subcontractors for any claim which may arise out of their performance of this Agreement. Furthermore, the contractor expressly understands and agrees that the provisions of this indemnification clause shall in no way limit the contractor's obligations assumed in this Agreement, nor shall they be construed to relieve the contractor from any liability, nor preclude the owner from taking any other actions available to it under any other provisions of the Agreement or otherwise at law.

Representative's Name/Title Print: JACOB TORNIEN
Representative's Signature: [Signature]
Name of Company: DRM INDUSTRY INC.
Tel. No.: 716-399-6311 Date: 5/5/14

**Minority/Woman Business Enterprise (MWBE)
Questionnaire for Bidders**

Jersey City Ordinance C-829 establishes a goal of awarding 20% of the dollar amount of total city procurement to minority and woman owned business enterprises.

To assist us in monitoring our achievement of this goal, please indicate below whether your company is or is not a minority owned and/or woman owned business, and return this form with your bid proposal.

Business Name : ORLY INDUSTRY INC
Address : 106 LEXINGTON AVE, BROOKLYN NY 11238.
Telephone No. : 718-399-6311
Contact Name : JACOB TORRETT

Please check applicable category :

Minority Owned Business (MBE) Minority & Woman Owned Business (MWBE)
 Woman Owned business (WBE) Neither

Definitions

Minority Business Enterprise

Minority Business Enterprise means a business which is a sole proprietorship, partnership or corporation at least 51% of which is owned and controlled by persons who are African American, Hispanic, Asian American, American Indian or Alaskan native, defined as follows:

African American: a person having origins in any of the black racial groups of Africa

Hispanic: a person of Mexican, Puerto Rican, Central or South American or other non-European Spanish culture or origin regardless of race.

Asian: a person having origins in any of the original peoples of the Far East, South East Asia, Indian subcontinent, Hawaii or the Pacific Islands.

American Indian or Alaskan Native: a person having origins in any of the original peoples of North America and who maintains cultural identification through tribal affiliation or community recognition.

Woman Business Enterprise

Woman Business Enterprise means a business which is a sole proprietorship, partnership or corporation at least 51% of which is owned and controlled by a woman or women.

OFFICE OF EQUAL OPPORTUNITY COPY

02/02/12

Taxpayer Identification# 271-082-351/000

Dear Business Representative:

Congratulations! You are now registered with the New Jersey Division of Revenue.

Use the Taxpayer Identification Number listed above on all correspondence with the Divisions of Revenue and Taxation, as well as with the Department of Labor (if the business is subject to unemployment withholdings). Your tax returns and payments will be filed under this number, and you will be able to access information about your account by referencing it.

Additionally, please note that State law requires all contractors and subcontractors with Public agencies to provide proof of their registration with the Division of Revenue. The law also amended Section 92 of the Casino Control Act, which deals with the casino service industry.

We have attached a Proof of Registration Certificate for your use. To comply with the law, if you are currently under contract or entering into a contract with a State agency, you must provide a copy of the certificate to the contracting agency.

If you have any questions or require more information, feel free to call our Registration Hotline at (609)292-9292.

I wish you continued success in your business endeavors.

Sincerely,



James J. Fruscione
Director
New Jersey Division of Revenue

STATE OF NEW JERSEY BUSINESS REGISTRATION CERTIFICATE		DEPARTMENT OF TRE DIVISION OF REVENUE PO BOX 252 TRENTON, NJ 08646-0
TAXPAYER NAME: ORLY INDUSTRY INC	TRADE NAME:	
ADDRESS: 106 LEXINGTON AVENUE BROOKLYN NY 11238	SEQUENCE NUMBER: 1692297	
EFFECTIVE DATE: 02/02/12	ISSUANCE DATE: 02/02/12	
FORM-BRC	 Director New Jersey Division of Revenue	
This Certificate is NOT assignable or transferable. It must be conspicuously displayed at above address		



New Jersey Division of Revenue

Revenue | NJBGS

On-Line Business Registration Certificate Service

CERTIFICATE NUMBER 1692297 FOR ORLY INDUSTRY INC IS VALID.

VERIFIED
PC

Resolution of the City of Jersey City, N.J.

City Clerk File No. Res. 14.494

Agenda No. 10.Z.1

Approved: JUL 16 2014

TITLE:



RESOLUTION AUTHORIZING THE AWARD OF AN OPEN-END CONTRACT TO PABCO INDUSTRIES TO SUPPLY AND DELIVER BEAM CLAY BASEBALL DIAMOND MIX FOR THE DEPARTMENT OF PUBLIC WORKS/DIVISION OF PARKS MAINTENANCE

COUNCIL

offered and moved adoption of the following Resolution:

WHEREAS, the City of Jersey City advertised for the receipt of bids on May 6, 2014 to Supply and Deliver Beam Clay Baseball Diamond Mix for the Department of Public Works/ Division of Park Maintenance ; and

WHEREAS, this contract was bid as a one-year (1) open-end contract with the following minimum and maximum quantities specified:

	<u>Minimum</u>	<u>Maximum</u>
Item No. 1 Diamond Mix	0	900 Tons

WHEREAS, the lowest bidder Barbato Nursery withdrew his bid; and

WHEREAS, Pabco Industries submitted the next lowest bid on Item No. 1 with a unit cost of \$118.80 per Ton; and

WHEREAS, the Purchasing Agent certified that he considers the bid submitted by Pabco Industries be fair and reasonable; and

WHEREAS, the sum of Ten Thousand (\$10,000.00) Dollars is available in **Parks Operating Account No. 01-201-28-375-209**; and

WHEREAS, the balance of the contract funds will be made available as orders are placed.

NOW, THEREFORE, be it resolved by the Municipal Council of the City of Jersey City that:

1. The Mayor or Business Administrator is authorized to execute an agreement with Pabco Industries to Supply and Deliver Beam Clay Baseball Diamond Mix for the Department of Public Works/Division of Parks Maintenance;
2. This contract is awarded as a one-year (1) open-end contract on Item No. 1 with a unit cost of \$118.80 per Ton;
3. The City reserves the right to extend the contract for up to (2) two additional (1) one year terms pursuant to specifications and bids thereon;
4. The minimum quantity of Item No.1 Diamond Mix ordered under the contract shall be 0 cases and the maximum quantity shall be 900 Tons;
5. The Chief Financial Officer shall prepare and execute certificates of available funds as orders are made during the term of the contract;

(continued on Page 2)

City Clerk File No. Res. 14.494
Agenda No. 10.Z.1 JUL 16 2014

TITLE:

RESOLUTION AUTHORIZING THE AWARD OF AN OPEN-END CONTRACT TO PABCO INDUSTRIES TO SUPPLY AND DELIVER BEAM CLAY BASEBALL DIAMOND MIX FOR THE DEPARTMENT OF PUBLIC WORKS/DIVISION OF PARKS MAINTENANCE

- 6. Upon certification by an official or employee of the City authorized to attest that the contractor has complied with specifications in all respects, and the requirements of the contract met, then payment to the contractor shall be made in accordance with the provisions of the Local Fiscal Affairs Law, N.J.S.A. 40A:5-1 et seq.; and
- 7. The award of this contract shall be subject to the condition that the contractor provide satisfactory evidence of compliance with the Affirmative Action Amendments to the Law Against Discrimination, N.J.S.A. 10:5-31 et seq.

I, Donna Mauer (Donna Mauer), Chief Financial Officer, certify that there are sufficient funds available for the payment of the above resolution in Account shown below

Department of Public Works/Division of Parks Maintenance

Acct #	P.O #	Temp. Encumb.	Amount
01-201-28-375-209	114047		\$10,000.00
TOTAL CONTRACT			\$106,920.00

Approved by Peter Folgado, Director of Purchasing, QPA 7/1/14

APPROVED: Gregory Bernard Business Administrator APPROVED AS TO LEGAL FORM
 APPROVED: [Signature] Corporation Counsel
 Certification Required
 Not Required

APPROVED 8-1

RECORD OF COUNCIL VOTE ON FINAL PASSAGE 7.16.14											
COUNCILPERSON	AYE	NAY	N.V.	COUNCILPERSON	AYE	NAY	N.V.	COUNCILPERSON	AYE	NAY	N.V.
GAJEWSKI	✓			YUN		✓		RIVERA	✓		
RAMCHAL	✓			OSBORNE	✓			WATTERMAN	✓		
BOGGIANO	✓			COLEMAN	✓			LAVARRO, PRES.	✓		

✓ Indicates Vote

N.V.-Not Voting (Abstain)

Adopted at a meeting of the Municipal Council of the City of Jersey City N.J.

[Signature]
Rolando R. Lavarro, Jr., President of Council

[Signature]
Robert Byrne, City Clerk

RESOLUTION FACT SHEET - CONTRACT AWARD

This summary sheet is to be attached to the front of any resolution that is submitted for Council consideration. Incomplete or vague fact sheets will be returned with the resolution.

Full Title of Ordinance/Resolution

RESOLUTION AWARDING AN OPEN - END CONTRACT TO PABCO INDUSTRIES TO SUPPLY AND DELIVER BEAM CLAY BASEBALL DIAMOND MIX FOR THE DEPARTMENT OF PUBLIC WORKS, DIVISION OF PARKS MAINTENANCE.

Project Manager

Department/Division	Public Works	Parks Maintenance
Name/Title	Cleveland Snow	Director
Phone/email	201-547-4495	csnow@jenj.org

Note: Project Manager must be available by phone during agenda meeting (Wednesday prior to council meeting @ 4:00 p.m.)

Awarding a contract for beam clay diamond mix. This was a public bid and awarding resolution will be drafted by Purchasing Division.

Cost (Identify all sources and amounts)

Contract term (include all proposed renewals)

Parks Operating Account (01-201-28-375-209)

Total Contract Amount = \$106,920.00
Temp. Encumbrancy Amount = \$10,000.00

Option to renew for up to two (2) additional one (1) year terms.

Type of award

If "Other Exception", enter type

Additional Information

Two (2) bid proposals were received:
1. Barbato Nursery = \$71,775.00 ****
2. Pabco Industries = \$106,920.00

**** Barbato Nursery withdrew its bid. The sample provided was not what the specifications called for (see attached letter from vendor).

I certify that all the facts presented herein are accurate.



Signature of Department Director

6/26/14

Date



**CITY OF JERSEY CITY
DEPARTMENT OF PUBLIC WORKS**

PUBLIC WORKS COMPLEX | 575 ROUTE 440 | JERSEY CITY, NJ 07305
P: 201.547.4402 | F: 201.547.4803



STEVEN M. FULOP
MAYOR OF JERSEY CITY

MICHAEL E. RAZZOLI
DIRECTOR

MEMORANDUM

Date: June 26, 2014

To: Rolando R. Lavarro, Jr; Council President and Members of the Municipal Council

From: Cleveland Snow, Parks Maintenance Director 

Subject: Contract Award (Beam Clay Baseball Diamond Mix)

There exists a need for beam clay baseball diamond mix. Two (2) proposals were received from:

Barbato Nursery = \$71,775.00
Pabco Industries = \$106,920.00

Barbato withdrew its bid proposal because the sample that was provided was not what the specifications requested. Therefore, the Law Department advised that we can proceed awarding the contract to the next bidder, Pabco Industries, 166 FRELINGHUYSEN AVENUE, NEWARK, NJ 07114 in the total bid amount of one hundred and six thousand nine hundred and twenty dollars and zero cents (\$106,920.00). Pabco's sample was what the specifications called for.

The key point is that the City is making a contract based on the lowest unit cost for an item. The bid specification is an open – end contract. It indicated a minimum and maximum number of tons. If the maximum quantity is ordered by the City during the contract term, then the total cost of the contract would be \$106,920.00.

<u>ITEM</u>	<u>MINIMUM</u>	<u>MAXIMUM</u>	<u>UNIT PRICE</u>	<u>TOTAL</u>
Diamond Mix	0	900	\$118.80	\$106,920.00

The resolution is encumbering \$10,000.00 for now. As the year progresses, and if the City needs more than \$10,000.00 worth of baseball diamond mix, additional funds are then encumbered through a change order under the authority of the contract award resolution.

CONTRACT FUNDING

Beam Clay Baseball Diamond Mix (Parks Operating Account)

- ❖ Expenditure is drawn down from Parks operating account, 01-201-28-375-209.
- ❖ Contract is utilizing object # 209.
- ❖ Line object 209 was budgeted for \$115,000.00 in CY 2014.
- ❖ As of today (06/26/14), \$18,924.41 has been spent in line object 209.
- ❖ This contract will lapse over two calendar years 2014 and 2015. Half of this contract Will be from 2014 budget and other half will be budgeted in 2015 budget.
- ❖ \$33,000.00 has been encumbered in object 209.

Should you have any questions/concerns or require further details regarding this matter, please do not hesitate to contact my office.

Thank you for your cooperation.



**CITY OF JERSEY CITY
DEPARTMENT OF PUBLIC WORKS**

PUBLIC WORKS COMPLEX | 575 ROUTE 440 | JERSEY CITY, NJ 07305
P: 201 547 4402 | F: 201 547 4803



STEVEN M. FULOP
MAYOR OF JERSEY CITY

MICHAEL E. RAZZOLI
DIRECTOR

MEMORANDUM

Date: June 26, 2014
To: Peter Folgado, Purchasing Director
From: Michael Razzoli , DPW Director
Subject: Recommendation Letter (Beam Clay)

Please be advised, after a careful and thorough review of bids received for Beam Clay, I recommend that the contract be awarded to:

**PABCO INDUSTRIES
166 FRELINGHUYSEN AVENUE
NEWARK, NJ 07114**

**Total contract Amount = \$106,920.00
Temporary Encumbrancy = \$10,000.00**

Please proceed and utilize the following requisitions listed below. Kindly draft the awarding resolution for the July 16th Council meeting.

REQ #	ACCOUNT NUMBER	AMOUNT
0165858	01-201-28-375-209 (Parks Operating Account)	\$10,000.00

Should you have any questions or need any additional justifications regarding this contract award, please do not hesitate to call my office at X 4400/01.

Michael Razzoli

Raquel Tosado, Contracts Manager
James Madden, DPW Deputy Director
Cleveland Snow, Director, Parks Maintenance
Hector Ortiz, Deputy Director of Operations
Bhavini Doshi, Confidential Aide, DPW Director's Office

Zakia Gregory, DPW Fiscal Office
Paola Campbell, Purchasing Division
Elizabeth Harley, Parks Maintenance

BARBATO NURSERY CORP.

1600 Railroad Avenue

Holbrook, NY 11741

631-285-6767

Fax 631-285-6748

Email: barbatolandscapes@aol.com

May 28, 2014

Mr. Cleveland Snow
City of Jersey City
Parks & Forestry, DPW
575 Rte 440
Jersey City, NJ 07305

Re: Beam Clay Baseball Diamond Mix

Dear Mr. Snow:

We hereby withdraw our bid for the above referenced contract as the sample that was enclosed with our bid was not the color that the City of Jersey City wanted. As a result of our meeting with you, and at your request, we withdraw our bid.

Respectfully,

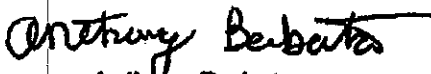

Anthony Barbato
President

BID PROPOSAL/DOCUMENTS

**BEAM CLAY BASEBALL DIAMOND MIX
DPW/DIVISION OF PARK MAINTENANCE**

This contract will be awarded as an open-end contract for a term of one year.
The minimum and the maximum number of quantities for each item are as stated below.

Zero (0) is the minimum, Nine hundred (900) is the maximum. Materials is to be delivered to the Department of Public Works. Deliveries are to be in increments of 25 tons delivered to Public Works as needed.

The contract will be awarded based upon the grand total price for item one (1). If the Grand Total Price is found to have been incorrectly computed, change will be made in any and all unit prices so as to attain conformity with the Grand Total Price before award

Item # 1. 900 - Tons @ \$ 118.50 Per Ton for a Total Cost of \$ 106,920.00
Price In Figures Total Cost In Figures

Grand Total Bid Price for 900 Tons of Baseball Diamond Mix

One Hundred and Six Thousand Nine hundred and Twenty
Grand Total Bid Amount In Words

\$ 106,920.00
(In Figures)

NOTE: This contract will be awarded as an open-end contract. The minimum and maximum number of quantities for each item are as stated. If zero is the minimum, the City is not obligated to order any quantities of that item during the contract term. If a specific number is stated for a minimum, then the City is obligated to purchase whatever that quantity is. Regardless of what the minimum quantity is set at, the vendor is still required to fill any order that the City places during the contract term until the maximum quantity is reached.

(REVISED 4/13)

EXHIBIT A
MANDATORY EQUAL EMPLOYMENT OPPORTUNITY LANGUAGE
N.J.S.A. 10:5-31 et seq. (P.L. 1975, C. 127)
N.J.A.C. 17:27

GOODS, PROFESSIONAL SERVICE AND GENERAL SERVICE CONTRACTS

During the performance of this contract, the contractor agrees as follows:

The contractor or subcontractor, where applicable, will not discriminate against any employee or applicant for employment because of age, race, creed, color, national origin, ancestry, marital status, affectional or sexual orientation, gender identity or expression, disability, nationality or sex. Except with respect to affectional or sexual orientation and gender identity or expression, the contractor will ensure that equal employment opportunity is afforded to such applicants in recruitment and employment, and that employees are treated during employment, without regard to their age, race, creed, color, national origin, ancestry, marital status, affectional or sexual orientation, gender identity or expression, disability, nationality or sex. Such equal employment opportunity shall include, but not be limited to the following: employment, upgrading, demotion, or transfer; recruitment or recruitment advertising; layoff or termination; rates of pay or other forms of compensation; and selection for training, including apprenticeship. The contractor agrees to post in conspicuous places, available to employees and applicants for employment, notices to be provided by the Public Agency Compliance Officer setting forth provisions of this nondiscrimination clause.

The contractor or subcontractor, where applicable will, in all solicitations or advertisements for employees placed by or on behalf of the contractor, state that all qualified applicants will receive consideration for employment without regard to age, race, creed, color, national origin, ancestry, marital status, affectional or sexual orientation, gender identity or expression, disability, nationality or sex.

The contractor or subcontractor will send to each labor union, with which it has a collective bargaining agreement, a notice, to be provided by the agency contracting officer, advising the labor union of the contractor's commitments under this chapter and shall post copies of the notice in conspicuous places available to employees and applicants for employment.

The contractor or subcontractor, where applicable, agrees to comply with any regulations promulgated by the Treasurer pursuant to N.J.S.A. 10:5-31 et seq., as amended and supplemented from time to time and the Americans with Disabilities Act.

The contractor or subcontractor agrees to make good faith efforts to meet targeted county employment goals established in accordance with N.J.A.C. 17:27-5.2.

EXHIBIT A (Continuation)

The contractor or subcontractor agrees to inform in writing its appropriate recruitment agencies including, but not limited to, employment agencies, placement bureaus, colleges, universities, and labor unions, that it does not discriminate on the basis of age, race, creed, color, national origin, ancestry, marital status, affectional or sexual orientation, gender identity or expression, disability, nationality or sex, and that it will discontinue the use of any recruitment agency which engages in direct or indirect discriminatory practices.

The contractor or subcontractor agrees to revise any of its testing procedures, if necessary, to assure that all personnel testing conforms with the principles of job-related testing, as established by the statutes and court decisions of the State of New Jersey and as established by applicable Federal law and applicable Federal court decisions.

In conforming with the targeted employment goals, the contractor or subcontractor agrees to review all procedures relating to transfer, upgrading, downgrading and layoff to ensure that all such actions are taken without regard to age, race, creed, color, national origin, ancestry, marital status, affectional or sexual orientation, gender identity or expression, disability, nationality or sex, consistent with the statutes and court decisions of the State of New Jersey, and applicable Federal law and applicable Federal court decisions.

The contractor shall submit to the public agency, after notification of award but prior to execution of a goods and services contract, one of the following three documents:

Letter of Federal Affirmative Action Plan Approval

Certificate of Employee Information Report

Employee Information Report Form AA302 (electronically provided by the Division and distributed to the public agency through the Division's website at www.state.nj.us/treasury/contract_compliance)

The contractor and its subcontractors shall furnish such reports or other documents to the Division of Purchase & Property, CCAU, EEO Monitoring Program as may be requested by this office from time to time in order to carry out the purposes of these regulations, and public agencies shall furnish such information as may be requested by the Division of Purchase & Property, CCAU, EEO Monitoring Program for conducting a compliance investigation pursuant to Subchapter 10 of the Administrative Code at N.J.A.C. 17:27.

The undersigned vendor certifies on their company's receipt, knowledge and commitment to comply with:

EXHIBIT A
N.J.S.A. 10:5-31 and N.J.A.C. 17:27
MANDATORY EQUAL EMPLOYMENT OPPORTUNITY LANGUAGE
Goods, Professional Services and General Service Contracts
(Mandatory Affirmative Action Language)

The undersigned vendor further agrees to furnish the required forms of evidence and

understands that their contract/company's bid shall be rejected as non-responsive if said contractor fails to comply with the requirements of N.J.S.A. 10:5-31 and N.J.A.C. 17:27.

Representative's Name/Title (Print):

Todd Sherman / Bid agent

Representative's Signature:

[Signature]

Name of Company:

Public Industries, Inc.

Tel. No.: 973 242-2200

Date: 4/20/17

APPENDIX A
AMERICANS WITH DISABILITIES ACT OF 1990
Equal Opportunity for Individuals with Disability

The contractor and the CITY of JEFFERSON (hereafter "owner") do hereby agree that the provisions of Title 11 of the Americans With Disabilities Act of 1990 (the "Act") (42 U.S.C. 5121 01 et seq.), which prohibits discrimination on the basis of disability by public entities in all services, programs, and activities provided or made available by public entities, and the rules and regulations promulgated pursuant thereto, are made a part of this contract. In providing any aid, benefit, or service on behalf of the owner pursuant to this contract, the contractor agrees that the performance shall be in strict compliance with the Act. In the event that the contractor, its agents, servants, employees, or subcontractors violate or are alleged to have violated the Act during the performance of this contract, the contractor shall defend the owner in any action or administrative proceeding commenced pursuant to this Act. The contractor shall indemnify, protect, and save harmless the owner, its agents, servants, and employees from and against any and all suits, claims, losses, demands, or damages, of whatever kind or nature arising out of or claimed to arise out of the alleged violation. The contractor shall, at its own expense, appear, defend, and pay any and all charges for legal services and any and all costs and other expenses arising from such action or administrative proceeding or incurred in connection therewith. In any and all complaints brought pursuant to the owner's grievance procedure, the contractor agrees to abide by any decision of the owner which is rendered pursuant to said grievance procedure. If any action or administrative proceeding results in an award of damages against the owner, or if the owner incurs any expense to cure a violation of the ADA which has been brought pursuant to its grievance procedure, the contractor shall satisfy and discharge the same at its own expense.

The owner shall, as soon as practicable after a claim has been made against it, give written notice thereof to the contractor along with full and complete particulars of the claim. If any action or administrative proceeding is brought against the owner or any of its agents, servants, and employees, the owner shall expeditiously forward or have forwarded to the contractor every demand, complaint, notice, summons, pleading, or other process received by the owner or its representatives.

It is expressly agreed and understood that any approval by the owner of the services provided by the contractor pursuant to this contract will not relieve the contractor of the obligation to comply with the Act and to defend, indemnify, protect, and save harmless the owner pursuant to this paragraph.

It is further agreed and understood that the owner assumes no obligation to indemnify or save harmless the contractor, its agents, servants, employees and subcontractors for any claim which may arise out of their performance of this Agreement. Furthermore, the contractor expressly understands and agrees that the provisions of this indemnification clause shall in no way limit the contractor's obligations assumed in this Agreement, nor shall they be construed to relieve the contractor from any liability, nor preclude the owner from taking any other actions available to it under any other provisions of the Agreement or otherwise at law.

Representative's Name/Title Print: Todd Shearon / Bid agent
Representative's Signature: _____
Name of Company: Public Interest, Inc.
Tel. No.: 973-243-2200 Date: 11/14

**Minority/Woman Business Enterprise (MWBE)
Questionnaire for Bidders**

Jersey City Ordinance C-829 establishes a goal of awarding 20% of the dollar amount of total city procurement to minority and woman owned business enterprises.

To assist us in monitoring our achievement of this goal, please indicate below whether your company is or is not a minority owned and/or woman owned business, and return this form with your bid proposal.

Business Name : Patre Industries, Inc
Address : 106 Frelinghuysen Ave Newark, NJ 07114
Telephone No. : 973 242-2200
Contact Name : Todd Sherman

Please check applicable category :

Minority Owned Business (MBE) Minority & Woman Owned Business (MWBE)
 Woman Owned business (WBE) Neither

**Definitions
Minority Business Enterprise**

Minority Business Enterprise means a business which is a sole proprietorship, partnership or corporation at least 51% of which is owned and controlled by persons who are African American, Hispanic, Asian American, American Indian or Alaskan native, defined as follows:

African American: a person having origins in any of the black racial groups of Africa

Hispanic: a person of Mexican, Puerto Rican, Central or South American or other non-European Spanish culture or origin regardless of race.

Asian: a person having origins in any of the original peoples of the Far East, South East Asia, Indian subcontinent, Hawaii or the Pacific Islands.

American Indian or Alaskan Native: a person having origins in any of the original peoples of North America and who maintains cultural identification through tribal affiliation or community recognition.

Woman Business Enterprise

Woman Business Enterprise means a business which is a sole proprietorship, partnership or corporation at least 51% of which is owned and controlled by a woman or women.

OFFICE OF EQUAL OPPORTUNITY COPY

STATE OF NEW JERSEY
BUSINESS REGISTRATION CERTIFICATE
FOR STATE AGENCY AND CASINO SERVICE CONTRACTORS

DEPARTMENT OF TREASURY/
DIVISION OF REVENUE
PO BOX 252
TRENTON, NJ 08646-0252

TAXPAYER NAME:

PABCO INDUSTRIES, L.L.C.

TRADE NAME:

PABCO INDUSTRIES

TAXPAYER IDENTIFICATION#:

SEQUENCE NUMBER:

0099926

ADDRESS:

166 FRELINGHUYSEN AVE
NEWARK NJ 07114

ISSUANCE DATE:

12/03/02

EFFECTIVE DATE:

06/10/88

FORM-BRC(08-01)

J.P. S. Kelly
Acting Director

This Certificate is NOT assignable or transferable. It must be conspicuously displayed at above address.

Certification 13205

CERTIFICATE OF EMPLOYEE INFORMATION REPORT
RENEWAL

This is to certify that the contractor listed below has submitted an Employee Information Report pursuant to N.J.A.C. 17:27-1.1 et. seq. and the State Treasurer has approved said report. This approval will remain in effect for the period of ~~15-DEC-2013~~ **15-DEC-2020**

PABCO INDUSTRIES, LLC
166 FRELINGHUYSEN AVE.
NEWARK

NJ 07102



A handwritten signature in black ink, appearing to read "Andrew P. Sidamon-Eristoff".

Andrew P. Sidamon-Eristoff
State Treasurer



New Jersey Division of Revenue

Revenue NJBGS

On-Line Business Registration Certificate Service

CERTIFICATE NUMBER 0099926 FOR PABCO INDUSTRIES, L.L.C. IS VALID.

VERIFIED
PC

Resolution of the City of Jersey City, N.J.

City Clerk File No. Res. 14.495
Agenda No. 10.Z.2
Approved: JUL 16 2014



TITLE:

RESOLUTION AUTHORIZING THE AWARD OF A CONTRACT TO FIELD TURF USA INC. FOR FIELD MAINTENANCE SERVICES FOR THE DEPARTMENT OF PUBLIC WORKS/PARKS MAINTENANCE

COUNCIL OFFERED AND MOVED ADOPTION OF THE FOLLOWING RESOLUTION:

WHEREAS, and in conformity with N.J.S.A. 40A:11-6.1(a) quotes were solicited for **Field Maintenance Services for Montgomery Gateway and Caven Point Fields**; and

WHEREAS, as per N.J.S.A. 40A:11-6.1(a) two (2) quotes were solicited with the lowest, responsive and responsible being that from Field Turf Company, 19393 SW Laurelhurst Way, Bend, Oregon 97702 in the total amount of **Nineteen Thousand Six Hundred Fifty Dollars (\$19,650.00)**; and

WHEREAS, the Purchasing Director has certified that he considers said proposal to be fair and reasonable; and

WHEREAS, the City is acquiring these services directly and openly as a statutorily permitted contract pursuant to the provisions of N.J.S.A. 19:44A-20.4 et seq. (Pay-to-Play Law); and

WHEREAS, the Director of the Department of Public Works has determined and certified in writing that the value of the contract will exceed \$17,500.00; and

WHEREAS, the contractor has completed and submitted a Business Entity Disclosure Certification which certifies that the contractor has not made any reportable contributions to the political candidate committees listed in the Business Entity Disclosure Certification in the previous one year, and that the contract will prohibit the contractor from making any reportable contributions during the term of the contract; and

WHEREAS, the contractor has submitted a Chapter 271 Political Contribution Disclosure Certification at least 10 days prior to the award of this contract; and

WHEREAS, the contractor has submitted its Certification of Compliance with the City's Contractor Pay-to-Play Reform Ordinance 08-128 adopted on September 3, 2008; and

WHEREAS, funds in the amount of \$19,650.00 are available in the **Park Maintenance Operating Account**.

Account	PO #	Amount
01-201-28-375-312	113991	\$19,650.00

(Continue on page 2)

TITLE:

RESOLUTION AUTHORIZING THE AWARD OF A CONTRACT TO FIELD TURF USA INC. FOR FIELD MAINTENANCE SERVICES FOR THE DEPARTMENT OF PUBLIC WORKS/PARKS MAINTENANCE

NOW, THEREFORE BE IT RESOLVED, by the Municipal Council of the City of Jersey City that:

1. A contract in the amount of \$19,650.00 for **Field Maintenance Services for Montgomery Gateway and Caven Point Fields** is awarded to **Field Turf USA, Inc** and the Purchasing Agent is directed to have such a contract drawn up and executed;
2. Upon certification by an official or employee of the City authorized to administer the contract met, payment to the contractor shall be made in accordance with the Local Fiscal Affairs Law, N.J.S.A. 40A:5-1 et seq.; and
3. The Business Entity Disclosure Certification, Chapter 271 Political Contribution Disclosure Certification, the Certification of Compliance with the City's Contractor Pay-to-Play Reform Ordinance, and the Determination of Value Certification, attached hereto and incorporated herein by reference, shall be placed on file with this resolution.

I Donna Mauer, Donna Mauer Chief Financial Officer, hereby certify that funds in the amount of \$19,650.00 are available in the **Park Maintenance Operating Account**.

Account	PO #	Amount
01-201-28-375-312	113991	\$19,650.00

P. Vega for P. Folgado, DM
Peter Folgado, 7-9-14
Director of Purchasing, QPA, RPPO

Donna Mauer,
Chief Financial Officer

PF/pv
6/26/14

APPROVED: [Signature]
APPROVED: [Signature]
Business Administrator

APPROVED AS TO LEGAL FORM
[Signature]
Corporation Counsel

Certification Required

Not Required

APPROVED 9-0

RECORD OF COUNCIL VOTE ON FINAL PASSAGE 7.16.14											
COUNCILPERSON	AYE	NAY	N.V.	COUNCILPERSON	AYE	NAY	N.V.	COUNCILPERSON	AYE	NAY	N.V.
GAJEWSKI	✓			YUN	✓			RIVERA	✓		
RAMCHAL	✓			OSBORNE	✓			WATTERMAN	✓		
BOGGIANO	✓			COLEMAN	✓			LAVARRO, PRES.	✓		

✓ Indicates Vote

N.V.-Not Voting (Abstain)

Adopted at a meeting of the Municipal Council of the City of Jersey City N.J.

[Signature]
Rolando R. Lavarro, Jr., President of Council

[Signature]
Robert Byrne, City Clerk

RESOLUTION FACT SHEET - CONTRACT AWARD

This summary sheet is to be attached to the front of any resolution that is submitted for Council consideration. Incomplete or vague fact sheets will be returned with the resolution.

Full Title of Ordinance/Resolution

RESOLUTION AUTHORIZING THE AWARD OF A CONTRACT TO FIELD TURF USA INC. FOR FIELD MAINTENANCE SERVICES FOR THE DEPARTMENT OF PUBLIC WORKS/PARKS MAINTENANCE.

Project Manager

Department/Division	DPW	Parks Maintenance
Name/Title	Cleveland Snow	Parks Director
Phone/email	201-547-4495	csnow@lenj.org

Note: Project Manager must be available by phone during agenda meeting (Wednesday prior to council meeting @ 4:00 p.m.)

Contract Purpose

There exists a need for field maintenance for Montgomery Gateway and Caven Point Fields.

Cost (Identify all sources and amounts)

Contract term (include all proposed renewals)

Park Maintenance Operating Account
01-201-28-375-312 for \$19,650.00

Type of award

If "Other Exception", enter type

Additional Information

Two (2) proposals were received:
1. Field Turf USA = \$19,650.00
2. Chenango Sports = \$23,975.00

This resolution has been drafted by the Purchasing Division.

I certify that all the facts presented herein are accurate.

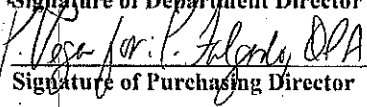
Signature of Department Director

Signature of Purchasing Director

6/27/14
Date
7.9.14
Date

DETERMINATION OF VALUE CERTIFICATION

I, Michael Razzoli, of full age, hereby certify the following:

1. I am the Director for the Department of Public Works.
2. There exists a need for field maintenance for Montgomery Gateway and Caven Point Fields for the Division of Park Maintenance.
3. The City informally solicited quotations for the maintenance of these fields.
4. The Department's recommendation is to award a contract to Field Turf USA Inc. for the field maintenance.
5. The cost of the Contract exceeds \$17,500.00.
6. This certification is made pursuant to N.J.S.A. 19:44A-20.5.
7. I certify that the foregoing statements are true. I am aware that if any of the following statements made by me are willfully false, I am subject to legal action to the fullest extent of the law.

6/27/14.

Date

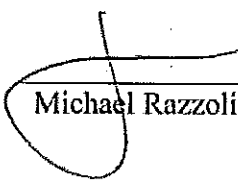
Michael Razzoli, DPW Director



New Jersey Division of Revenue

Revenue NJBGS

On-Line Business Registration Certificate Service

CERTIFICATE NUMBER 0933885 FOR FIELDTURF USA INC. IS VALID.

P.O. NO.	FIELDTURF					CHENANGO SPORTS						
REQ. NO.	166690	TIFFANY LANGE										
DIV/DEPT	PARK MAINTENANCE											
ITEM #	DESCRIPTION	QTY	UNIT	UNIT COST	EXT AMT	UNIT COST	EXT AMT	UNIT COST	EXT AMT	UNIT COST	EXT AMT	
1	MONTGOMERY AND	1	EA	\$ 19,650.00	\$ 19,650.00	\$ 23,975.00	\$23,975.00	\$ -	\$ -	\$ -	\$ -	
2	CAVEN PT FIELDS SERVICE			\$ -	\$ -							
3	LATE JUNE - DEC 2014			\$ -	\$ -							
4				\$ -	\$ -							
5				\$ -	\$ -							
6				\$ -	\$ -							
7				\$ -	\$ -							
8				\$ -	\$ -							
9				\$ -	\$ -							
10				\$ -	\$ -							
11				\$ -	\$ -							
12				\$ -	\$ -							
13				\$ -	\$ -							
14				\$ -	\$ -							
15				\$ -	\$ -							
		SUB-TOTAL			\$ 19,650.00		\$23,975.00		\$ -		\$ -	
	SHIPPING/HANDLING				\$ -						\$ -	
		TOTAL			\$ 19,650.00		\$23,975.00		\$ -		\$ -	

NOTES:

Req # 0166690



FieldTurf

A Tarkett Sports Company

THE ULTIMATE
SURFACE EXPERIENCE

To: **Mr. Cleveland Snow**
City of Jersey City
Public Works Complex
575 Route 440
Jersey City, NJ 07305
Phone: (201) 547-4402
Fax: (201) 547-4803

June 6, 2014

Re: **MAINTENANCE PROPOSAL FOR CITY OF JERSEY CITY**

1-FieldTurf offers to provide maintenance services for the following FieldTurf field:

Field Name: Montgomery Avenue- SRI Field
Size: 71,340 sqft
Use: Multipurpose
Product: SRI Slit-Film over E-Layer
Install Date: 2003

The scope of services under this proposal shall consist of the following on each visit offered herein:

ADVANCED CARE- Deep Power Groom; SMG Sportchamp grooming session including: (a) a general sweeping to remove foreign objects such as dirt, leaves, bird droppings, gum and other debris that may collect on the field surface; and (b) a deep groom, sweep and rejuvenation to de-compact infill and in an effort to maintain appropriate G-Max levels.

STANDARD CARE- Comprehensive Grooming: Brushing, Aerating, Raking and Sweeping of FieldTurf surface. Cleaning of surface field debris, light de-compaction of infill (based on fiber type, age, use and infill depth), field sweeping and magnet sweep, and add infill as needed to high traffic areas (do not exceed 250 lbs).

Overall analysis and inspection of the field and its applicable systems, including fiber wear analysis, ultraviolet degradation, infill depth and consistency, infill migration, field edging attachments, sewn and glued seams, line verification and field inserts (inlays).

Up to eight (8) minor repairs (including sewing/adhesive failures, inlay separation, and general workmanship) to the FieldTurf surface, in the discretion of the FieldCare crew at time of visit. If necessary, additional repairs can be performed on a separate visit and at an additional cost, if applicable.

This offer does not include the repair of *any damage to the field as a result of acts of vandalism and/or neglect*. The price includes normal wear and tear; any major repairs or necessary maintenance as a result of damage due to abnormal wear and tear, abuse, vandalism, or neglect are subject to additional cost.

Deep Power Groom & Infill Cleaning with De-Compaction (3 Step Process):

- Step 1: De-compaction
- Step 2: Brushing with vacuum process and infill cleaning
- Step 3: Fine groom with surface brush

Program 1- One (1) Year Agreement: Three (3) site visits to Montgomery Avenue- SRI Field

- Includes:
- Two (2) **Advanced Care Visits**
 - One (1) **Standard Care Visit**
 - Pre and Post Field Inspections with written Field Maintenance Summary

FieldTurf USA, Inc. 7445 Côte-de-Liesse Rd., Suite 200 Montréal, Québec H4T 1G2 Canada
Toll Free: 1-800-724-2969 Tel.: (514) 340-9311 Fax: (514) 340-9374 Website: <http://www.fieldturfarkett.com>



Monty
THE ULTIMATE
SURFACE EXPERIENCE

- Seam and Inlay Repairs, not to exceed eight (8) repairs up to fifteen (15) linear sqft
- Field Magnet Sweep
- Light Infill added to High Traffic Areas

Program 2- One (1) Annual GMAX Test with Written Report for Montgomery Avenue- SRI Field

*In combination with Program 1

2-The price offered is the following:

PROGRAM 1:	TOTAL COST PROGRAM 1:	\$8,150.00
PROGRAM 2:	TOTAL COST PROGRAM 2:	\$ 500.00

8650.-

The price is subject to an increase without notice in the event that there is an increase in raw materials, freight, or direct expenses in maintaining the grass surface. The Price is valid for a period of sixty (60) days.

3- Notwithstanding any other document or agreement entered into by FieldTurf in connection with the supply and installation only of its product pursuant to the present proposal, the following shall apply:

- a) This bid proposal and its acceptance is subject to strikes, accidents, delays beyond our control and force majeure;
- b) Payment shall be due within thirty (30) days of completion of each scheduled maintenance visit;
- c) Unless otherwise agreed upon and noted herein, the maintenance visit shall be performed as scheduled by the parties on an agreed-upon date;
- d) Accounts overdue beyond 30 days of billing will be charged at an interest rate of 1.5% per month (19.56% per annum);
- e) This proposal is based on a single mobilization. If the site is not ready and additional mobilizations are necessary additional charges will apply;
- f) The proposed price does not include any applicable sales or use taxes;
- g) In the event that FieldTurf is ultimately obliged to take collection procedures for payment, acceptor of this bid shall be liable for FieldTurf's collection costs including attorney fees and costs.

FieldTurf USA, Inc.

Per: *Tiffany Lange*
Tiffany Lange, FieldCare Program Manager

In order for FieldTurf to schedule and execute above services, a signed agreement and/or PO from the customer must be sent to FieldTurf directly.

RETURN SIGNED AGREEMENT AND/OR PO TO:

FieldTurf USA, Inc.
Attn: Tiffany Lange
19393 SW Laurelhurst Way
Bend, Oregon 97702
Fax: 503.692.4869
Email: tlange@fieldturf.com

*PO/Agreement can be mailed, emailed and/or faxed

READ, AGREED, AND ACCEPTED BY ADDRESSEE

Signature: _____
Print Name: _____
Date: _____
PO #: _____
Program Selection: _____

Req # 6166690



FieldTurf

A Tarkett Sports Company

THE ULTIMATE
SURFACE EXPERIENCE

To: Mr. Cleveland Snow
City of Jersey City
Public Works Complex
575 Route 440
Jersey City, NJ 07305
Phone: (201) 547-4402
Fax: (201) 547-4803

June 6, 2014

Re: MAINTENANCE PROPOSAL FOR CITY OF JERSEY CITY

1-FieldTurf offers to provide maintenance services for the following FieldTurf field:

Field Name: Caven Point Field
Size: 153,860 sqft
Use: Multipurpose
Product: FTOM 1F
Install Date: 10/03/2008

The scope of services under this proposal shall consist of the following on each visit offered herein:

ADVANCED CARE- Deep Power Groom: SMG Sportchamp grooming session including: (a) a general sweeping to remove foreign objects such as dirt, leaves, bird droppings, gum and other debris that may collect on the field surface and (b) a deep groom, sweep and rejuvenation to de-compact infill and in an effort to maintain appropriate G-Max levels.

STANDARD CARE- Comprehensive Grooming: Brushing, Aerating, Raking and Sweeping of FieldTurf surface. Cleaning of surface field debris, light de-compaction of infill (based on fiber type, age, use and infill depth), field sweeping and magnet sweep, and add infill as needed to high traffic areas (do not exceed 250 lbs).

Overall analysis and inspection of the field and its applicable systems, including fiber wear analysis, ultraviolet degradation, infill depth and consistency, infill migration, field edging attachments, sewn and glued seams, line verification and field inserts (inlays).

Up to eight (8) minor repairs (including sewing/adhesive failures, inlay separation, and general workmanship) to the FieldTurf surface, in the discretion of the FieldCare crew at time of visit. If necessary, additional repairs can be performed on a separate visit and at an additional cost, if applicable.

This offer does not include the repair of *any damage to the field as a result of acts of vandalism and/or neglect*. The price includes normal wear and tear; any major repairs or necessary maintenance as a result of damage due to abnormal wear and tear, abuse, vandalism, or neglect are subject to additional cost.

Deep Power Groom & Infill Cleaning with De-Compaction (3 Step Process):

- Step 1: De-compaction
- Step 2: Brushing with vacuum process and infill cleaning
- Step 3: Fine groom with surface brush

Program 1- One (1) Year Agreement: Three (3) site visits to Caven Point Field

- Includes: -Two (2) **Advanced Care Visits**
- One (1) **Standard Care Visit**
- Pre and Post Field Inspections with written Field Maintenance Summary



THE ULTIMATE
SURFACE EXPERIENCE

- Seam and Inlay Repairs, not to exceed eight (8) repairs up to fifteen (15) linear sqft
- Field Magnet Sweep
- Light Infill added to High Traffic Areas

Program 2- One (1) Annual GMAX Test with Written Report for Caven Point Field

*In combination with Program 1

Program 3 - Supply 2- Supersacks of Cryogenic "A" rubber infill - 4,000lbs

*City of Jersey City to provide Fork-Lift for transport upon delivery

Caven PT.

2-The price offered is the following:

PROGRAM 1:	TOTAL COST PROGRAM 1:	\$8,750.00
PROGRAM 2:	TOTAL COST PROGRAM 2:	\$ 500.00
PROGRAM 3:	TOTAL COST PROGRAM 3:	\$1,750.00

11,000

The price is subject to an increase without notice in the event that there is an increase in raw materials, freight, or direct expenses in maintaining the grass surface. The Price is valid for a period of sixty (60) days.

3- Notwithstanding any other document or agreement entered into by FieldTurf in connection with the supply and installation only of its product pursuant to the present proposal, the following shall apply:

- This bid proposal and its acceptance is subject to strikes, accidents, delays beyond our control and force majeure;
- Payment shall be due within thirty (30) days of completion of each scheduled maintenance visit;
- Unless otherwise agreed upon and noted herein, the maintenance visit shall be performed as scheduled by the parties on an agreed-upon date;
- Accounts overdue beyond 30 days of billing will be charged at an interest rate of 1.5% per month (19.56% per annum);
- This proposal is based on a single mobilization. If the site is not ready and additional mobilizations are necessary additional charges will apply;
- The proposed price does not include any applicable sales or use taxes;
- In the event that FieldTurf is ultimately obliged to take collection procedures for payment, acceptor of this bid shall be liable for FieldTurf's collection costs including attorney fees and costs.

FieldTurf USA, Inc.

Per: *Tiffany Lange*

Tiffany Lange, FieldCare Program Manager

In order for FieldTurf to schedule and execute above services, a signed agreement and/or PO from the customer must be sent to FieldTurf directly.

RETURN SIGNED AGREEMENT AND/OR PO TO:

FieldTurf USA, Inc.
Attn: Tiffany Lange
19393 SW Laurelhurst Way
Bend, Oregon 97702
Fax: 503.692.4869
Email: tlange@fieldturf.com

*PO/Agreement can be mailed, emailed and/or faxed

READ, AGREED, AND ACCEPTED BY ADDRESSEE

Signature: _____

Print Name: _____

Date: _____

PO #: _____

Program Selection: _____



Proposal for: Advanced FieldCare Service

Mr. Cleveland Snow
City of Jersey City
Public Works Complex
575 Route 440
Jersey City, NJ 07305

Attention: Cleveland Snow

Date: 6/7/2013

Chenango Contracting, Inc. offers to provide Two (2) Advanced FieldCare visit, One (1) Standard Care visit, and One (1) G-Max test on Caven Point Field

Field Name: Caven Point Field

Description of Service: Two (2) Advanced FieldCare visit, One (1) Standard Care Visit, and One (1) G-Max test on Caven Point Field.

The Advanced FieldCare service is applied with the SMG SportChamp groomer and will include:

- Pre-Field Inspection (includes ten different analyses)
- Heavy De-Compact the infill (restores resiliency and drainage capacity)
- Magnet Sweeping
- Deep Cleaning of Debris
- Surface grooming (evenly redistribute infill materials)
- Re-glue all inlays
- All Seam Repair up to 15 linear feet
- Add infill as needed to high traffic areas
- Take infill depth measurements at designated areas
- Remove and treat all weeds and grass from edges

Advanced Care Grooming Procedure:

1. Decompaction of infill – Run Field Metal Magnet
2. Power brush and Clean Infill- Using Rotary Brush and Sifting Tray
3. Static Brush and Redistribute the Infill- Brush in a Minimum of Two Directions

Synthetic field located at: Caven Point Field 575 Route 440, Jersey City, NJ 07305

Date of Service: Open

Proposal Price: \$23,975.00 (Plus tax if applicable)

Owner Signature: _____ Date: _____

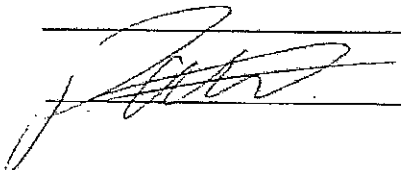
Contractor Signature:  Date: 6/7/2014

*Valid till Dec. 2014

CHENANGO CONTRACTING, INC
29 Arbutus Rd. • Johnson City, NY 13790
T: (607) 729-8500 • F: (607) 729-2415
www.chenangocontracting.com

C. 271 POLITICAL CONTRIBUTION DISCLOSURE FORM

Required Pursuant To N.J.S.A. 19:44A-20.26

This form or its permitted facsimile must be submitted to the local unit no later than 10 days prior to the award of the contract.

Part I - Vendor Information

Vendor Name:	FieldTurf USA, Inc		
Address:	175 W. Industrial Blvd.		
City:	Calhoun	State:	Georgia
		Zip:	30701

The undersigned being authorized to certify, hereby certifies that the submission provided herein represents compliance with the provisions of N.J.S.A. 19:44A-20.26 and as represented by the Instructions accompanying this form.

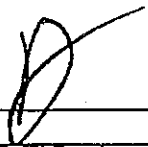
	Darren Gill	VP - Global Marketing
Signature	Printed Name	Title

Part II - Contribution Disclosure

Disclosure requirement: Pursuant to N.J.S.A. 19:44A-20.26 this disclosure must include all reportable political contributions (more than \$300 per election cycle) over the 12 months prior to submission to the committees of the government entities listed on the form provided by the local unit.

Check here if disclosure is provided in electronic form.

Contributor Name	Recipient Name	Date	Dollar Amount
None	None	N/A	\$ 0.00

Check here if the information is continued on subsequent page(s)

**BUSINESS ENTITY DISCLOSURE CERTIFICATION
FOR NON-FAIR AND OPEN CONTRACTS
Required Pursuant To N.J.S.A. 19:44A-20.8
CITY OF JERSEY CITY**

Part I - Vendor Affirmation

The undersigned, being authorized and knowledgeable of the circumstances, does hereby certify that the <name of business entity> has not made and will not make any reportable contributions pursuant to N.J.S.A. 19:44A-1 et seq. that pursuant to P.L. 2004, c. 19 would bar the award of this contract in the one year period preceding (date of award scheduled for approval of the contract by the governing body) to any of the following named candidate committees, joint candidates committee; or political party committee representing the elected officials of the <name of entity of elected officials> as defined pursuant to N.J.S.A. 19:44A-3(p), (q) and (r).

Election Fund for Steven Fulop (2013)	Councilperson Frank Gajewski
Team Fulop	Councilperson Khemraj "Chico" Ramchar
Team Fulop Runoff	Councilperson Richard Boggiano
Lavacro for Council	Councilperson Michael Ynn
Councilperson Joyce B. Watterman	Councilperson Candice Osborne
Councilperson Daniel Rivera	Councilperson Diana Coleman

Part II - Ownership Disclosure Certification

I certify that the list below contains the names and home addresses of all owners holding 10% or more of the issued and outstanding stock of the undersigned.

Check the box that represents the type of business entity:

- Partnership
 Corporation
 Sole Proprietorship
 Subchapter S Corporation
 Limited Partnership
 Limited Liability Corporation
 Limited Liability Partnership

Name of Stock or Shareholder	Home Address
FieldTurf Turf USA Holdings, Inc.	1209 Orange Street, Wilmington Delaware, 19802, USA
N/A	
N/A	
N/A	
N/A	
N/A	
N/A	
N/A	
N/A	
N/A	

Part III - Signature and Attestation:

The undersigned is fully aware that if I have misrepresented in whole or part this affirmation and certification, I and/or the business entity, will be liable for any penalty permitted under law.

Name of Business Entity: FieldTurf USA, Inc.
Signed: [Signature] Title: CEO
Print Name: Alan Murphy Date: 7/2/2014

Subscribed and sworn before me this 2nd day of July, 2014.

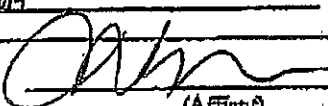
 (Affiant)
MORR-FELDER NANCY, Assistant Secretary
 (Print name & title of affiant) (Corporate Seal)

My Commission expires:

**CERTIFICATION OF COMPLIANCE WITH THE CITY OF JERSEY CITY
CONTRACTOR PAY-TO-PLAY REFORM ORDINANCE 08-128 ADOPTED
ON SEPTEMBER 3, 2008**

PART I - Vendor Affirmation

The undersigned, being authorized and knowledgeable of the circumstances, does hereby certify that
(name of business entity) has not made any reportable
contributions in the one-year period preceding 7/1/2014 (date City Council
awards contract) that would be deemed to be violations of Section One of the City of Jersey City's
Contractor Pay-to-Play Reform Ordinance 08-128 (attached hereto) and that would bar the award
of this contract. I further certify that during the term of the contract
(name of business entity) will not make any reportable contributions in violation of Ordinance 08-
128.

PART II - Signature and Attestation

The undersigned is fully aware that if I have misrepresented in whole or part this affirmation and
certification, I and/or the business entity, will be liable for any penalty permitted under law.

Name of Business Entity: FieldTurf USA, Inc.

Signed: [Signature] Title: CEO

Print Name: Alain Toussaint Date: 7/1/2014

Subscribed and sworn before me
this 2nd day of July, 2014.
My Commission expires:

[Signature]
(Affiant)
Maria Elaine Nanted, Assistant Secretary
(Print name & title of official) (Corporate Seal)

****Pursuant to Section 2 of Ordinance 08-128, no contributions or solicitation of
contributions made prior to the effective date Ordinance 08-128 (September 23, 2008)
shall be deemed to be a violation of the Ordinance.**

C. 271 POLITICAL CONTRIBUTION DISCLOSURE FORM

Required Pursuant To N.J.S.A. 19:44A-20.26

This form or its permitted facsimile must be submitted to the local unit no later than 10 days prior to the award of the contract.

Part I - Vendor Information

Vendor Name:	Fieldturf USA, Inc.		
Address:	175 W. Industrial Blvd.		
City:	Calhoun	State:	Georgia
		Zip:	30701

The undersigned being authorized to certify, hereby certifies that the submission provided herein represents compliance with the provisions of N.J.S.A. 19:44A-20.26 and as represented by the instructions accompanying this form.

Alan Tanguay Alan Tanguay CEO
 Signature Printed Name Title

Part II - Contributions Disclosure

Disclosure requirement: Pursuant to N.J.S.A. 19:44A-20.26 this disclosure must include all reportable political contributions (more than \$300 per election cycle) over the 12 months prior to submission to the committees of the government entities listed on the form provided by the local unit.

Check here if disclosure is provided in electronic form.

Contributor Name	Recipient Name	Date	Dollar Amount
None	None	N/A	\$ 0.00

Check here if the information is continued on subsequent page(s)

Certification

CERTIFICATE OF EMPLOYEE INFORMATION REPORT 34146

RENEWAL

This is to certify that the contractor listed below has submitted an Employee Information Report pursuant to N.J.A.C. 17:27-1.1 et. seq. and the State Treasurer has approved said report. This approval will remain in effect for the period of

15-MAR-2013 to 15-MAR-2016

FIELDTUF USA, INC.
175 N INDUSTRIAL BLVD.
CALHOUN GA 30721

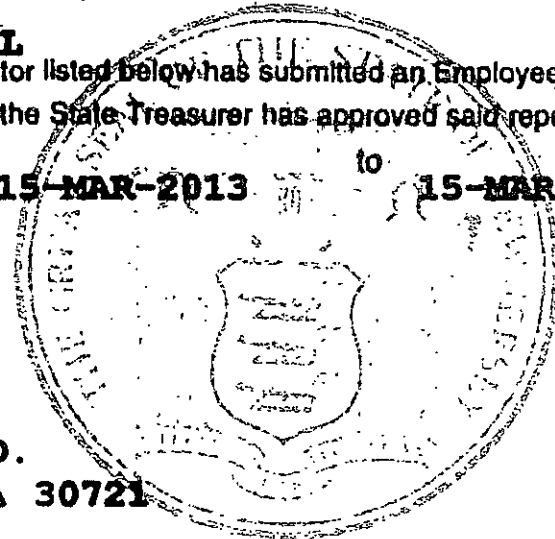

A handwritten signature in black ink, appearing to read "Andrew P. Sidamon-Eristoff".

Andrew P. Sidamon-Eristoff
State Treasurer

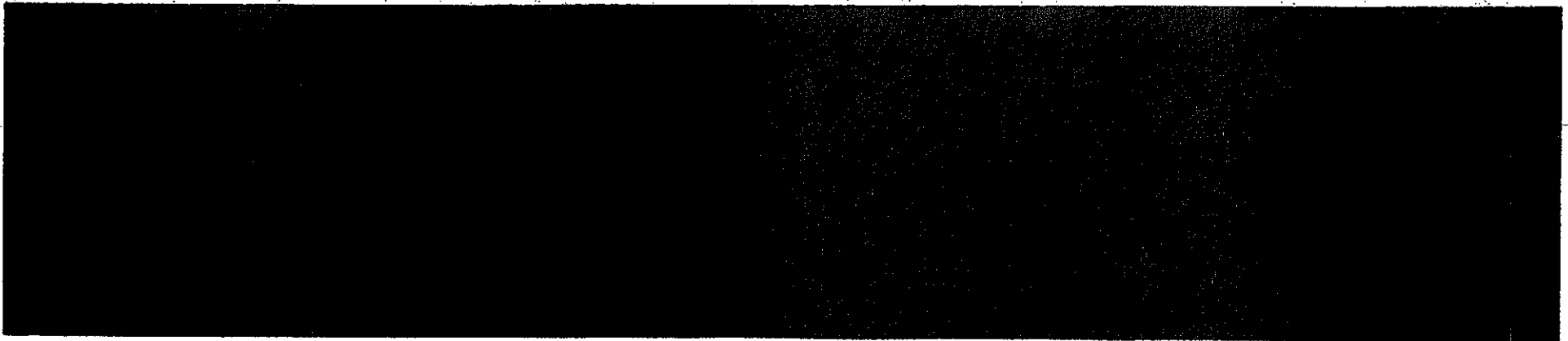

06/26/13

Taxpayer Identification#

Dear Business Representative:

JUL 02 2013
Congratulations! You are now registered with the New Jersey Division of Revenue.

Use the Taxpayer Identification Number listed above on all correspondence with the Divisions of Revenue and Taxation, as well as with the Department of Labor (if the business is subject to unemployment withholdings). Your tax returns and payments will be filed under this number, and you will be able to access information about your account by referencing it.

Additionally, please note that State law requires all contractors and subcontractors with Public agencies to provide proof of their registration with the Division of Revenue. The law also amended Section 92 of the Casino Control Act, which deals with the casino service industry.

We have attached a Proof of Registration Certificate for your use. To comply with the law, if you are currently under contract or entering into a contract with a State agency, you must provide a copy of the certificate to the contracting agency.

If you have any questions or require more information, feel free to call our Registration Hotline at (800)292-9292.

I wish you continued success in your business endeavors.

Sincerely,

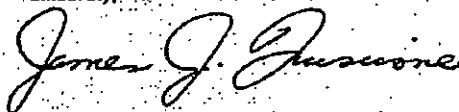

James J. Fruscione
Director
New Jersey Division of Revenue

STATE OF NEW JERSEY BUSINESS REGISTRATION CERTIFICATE		DEPARTMENT OF TREASURY DIVISION OF REVENUE PO BOX 352 TRENTON, N.J. 08646-0252
TAXPAYER NAME: FIELDTURF USA INC.	TRADE NAME:	
ADDRESS: 175 N. INDUSTRIAL BLVD CALHOUN GA 30701	SEQUENCE NUMBER: 0933685	
EFFECTIVE DATE: 09/08/02	ISSUANCE DATE: 06/26/13	
FORM-BRC		Director New Jersey Division of Revenue

This Certificate is NOT assignable or transferable. It must be conspicuously displayed at above address.



State of New Jersey

CHRIS CHRISTIE
Governor

DEPARTMENT OF THE TREASURY
DIVISION OF REVENUE & ENTERPRISE SERVICES
P.O. BOX 026
TRENTON, NJ 08625-034
PHONE: 609-292-2146 FAX: 609-984-6679

KIM GUADAGNO
Lt. Governor

ANDREW P. SIDAMON-ERISTOFF
State Treasurer

APPROVED
under the

Small Business Set-Aside Act and Minority and Women Certification Program

This certificate acknowledges The FieldTurf USA, Inc. as a Category 1 and 4 approved Small Business Enterprise that has met the criteria established by N.J.A.C. 17:13 and/or 17:14.1

This registration will remain in effect for three years. Annually the business must submit, not more than 20 days prior to the anniversary of the registration notice, an annual verification statement in which it shall attest that there is no change in the ownership, revenue eligibility or control of that business.

If the business fails to submit the annual verification statement by the anniversary date, the registration will lapse and the business will be removed from the SAVI that lists registered small businesses. If the business seeks to be registered again, it will have to reapply and pay the \$100 application fee. In this case, a new application must be submitted prior the expiration date of this registration.

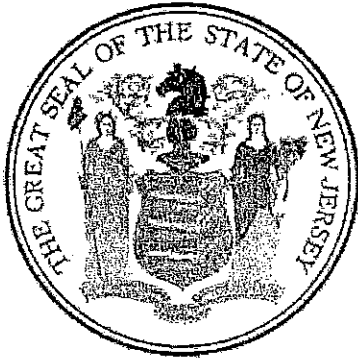

Andrew Pantelides
Assistant Director

Issued: 3/5/2013
Certification Number: A0004-08

Expiration: 3/5/2016

**STATE OF NEW JERSEY
DEPARTMENT OF THE TREASURY
SHORT FORM STANDING**

FIELDTURF USA INC.

0400015586

With the Previous or Alternate Name

FIELDTURF INTERNATIONAL INC (Previous Name)

I, the Treasurer of the State of New Jersey, do hereby certify that the above-named Florida Foreign Profit Corporation was registered by this office on September 4, 2002.

As of the date of this certificate, said business continues as an active business in good standing in the State of New Jersey, and its Annual Reports are current.

I further certify that the registered agent and registered office are:

*The Corporation Trust Company
820 Bear Tavern Road
West Trenton, NJ 08628*



Certification# 123076203

*IN TESTIMONY WHEREOF, I have
hereunto set my hand and affixed my
Official Seal at Trenton, this
16th day of February, 2012*

A handwritten signature in black ink, appearing to read "Andrew P. Sidamon-Eristoff".

*Andrew P Sidamon-Eristoff
State Treasurer*

Verify this certificate at
https://www1.state.nj.us/TYTR_StandingCert/JSP/Verify_Cert.jsp

STOCKHOLDER DISCLOSURE CERTIFICATION

Name of Business:

I certify that the list below contains the names and home addresses of all stockholders holding 10% or more of the issued and outstanding stock of the undersigned.
OR

I certify that no one stockholder owns 10% or more of the issued and outstanding stock of the undersigned.

Check the box that represents the type of business organization:

- Partnership Corporation Sole Proprietorship
 Limited Partnership Limited Liability Corporation Limited Liability Partnership
 Subchapter S Corporation

Sign and notarize the form below, and, if necessary, complete the stockholder list below.

Stockholders:

Name: FieldTurf Tarkett USA Holdings Inc.	Name: N/A
Home Address: 1209 Orange Street, Wilmington, Delaware 19801, USA.	Home Address:
Name: N/A	Name: N/A
Home Address:	Home Address:
Name: N/A	Name: N/A
Home Address:	Home Address:

Subscribed and sworn before me this 20th day of March, 2013

(Notary Public) Suzanne J. [Signature] # 202855

My Commission expires: January 23, 2016

[Signature]
(Affiant)
Darren Gill, VP - Global Marketing
(Print name & title of affiant)

(Corporate Seal)

Amount of Sale	Tax to be Collected	Amount of Sale	Tax to be Collected
\$0.01 to \$0.10 ..	None	\$5.91 to \$6.10 ..	\$0.42
0.11 to 0.19 ..	\$0.01	6.11 to 6.19 ..	.43
0.20 to 0.32 ..	.02	6.20 to 6.32 ..	.44
0.33 to 0.47 ..	.03	6.33 to 6.47 ..	.45
0.48 to 0.62 ..	.04	6.48 to 6.62 ..	.46
0.63 to 0.77 ..	.05	6.63 to 6.77 ..	.47
0.78 to 0.90 ..	.06	6.78 to 6.90 ..	.48
0.91 to 1.10 ..	.07	6.91 to 7.10 ..	.49
1.11 to 1.19 ..	.08	7.11 to 7.19 ..	.50
1.20 to 1.32 ..	.09	7.20 to 7.32 ..	.51
1.33 to 1.47 ..	.10	7.33 to 7.47 ..	.52
1.48 to 1.62 ..	.11	7.48 to 7.62 ..	.53
1.63 to 1.77 ..	.12	7.63 to 7.77 ..	.54
1.78 to 1.90 ..	.13	7.78 to 7.90 ..	.55
1.91 to 2.10 ..	.14	7.91 to 8.10 ..	.56
2.11 to 2.19 ..	.15	8.11 to 8.19 ..	.57
2.20 to 2.32 ..	.16	8.20 to 8.32 ..	.58
2.33 to 2.47 ..	.17	8.33 to 8.47 ..	.59
2.48 to 2.62 ..	.18	8.48 to 8.62 ..	.60
2.63 to 2.77 ..	.19	8.63 to 8.77 ..	.61
2.78 to 2.90 ..	.20	8.78 to 8.90 ..	.62
2.91 to 3.10 ..	.21	8.91 to 9.10 ..	.63
3.11 to 3.19 ..	.22	9.11 to 9.19 ..	.64
3.20 to 3.32 ..	.23	9.20 to 9.32 ..	.65
3.33 to 3.47 ..	.24	9.33 to 9.47 ..	.66
3.48 to 3.62 ..	.25	9.48 to 9.62 ..	.67
3.63 to 3.77 ..	.26	9.63 to 9.77 ..	.68
3.78 to 3.90 ..	.27	9.78 to 9.90 ..	.69
3.91 to 4.10 ..	.28	9.91 to 10.10 ..	.70*
4.11 to 4.19 ..	.29	Over \$1070*
4.20 to 4.32 ..	.30	Over \$20	1.40*
4.33 to 4.47 ..	.31	Over \$30	2.10*
4.48 to 4.62 ..	.32	Over \$40	2.80*
4.63 to 4.77 ..	.33	Over \$50	3.50*
4.78 to 4.90 ..	.34	Over \$60	4.20*
4.91 to 5.10 ..	.35	Over \$70	4.90*
5.11 to 5.19 ..	.36	Over \$80	5.60*
5.20 to 5.32 ..	.37	Over \$90	6.30*
5.33 to 5.47 ..	.38	Over \$100	7.00*
5.48 to 5.62 ..	.39	Over \$200	14.00*
5.63 to 5.77 ..	.40	Over \$300	21.00*
5.78 to 5.90 ..	.41	Over \$400	28.00*

* On amounts above \$10.00, the tax shall be \$0.07 on each full dollar of the amount of sale, plus the tax on each part of a dollar in excess of a full dollar in accordance with the above formula.
ST-75 (7-05)

NOTICE: The enclosed N.J. State Sales Tax Certificate of Authority (CA-1) is a permit to:
- Collect N.J. State Sales Tax
- Issue N.J. Resale Certificates (ST-3)
- Issue N.J. Exempt Use Certificates (ST-4)
You must have a valid N.J. Sales Tax Certificate to collect Sales Tax or issue certificates.
If you are not subject to collect N.J. Sales Tax but need to issue Resale or Exempt Use Certificates, you can request to be placed on a "Non-reporting Basis". Call or write the Division to obtain the proper forms (ST-6205) at:
State of New Jersey Division of Taxation P O Box 252 Trenton, N.J. 08646-0252 (609) 292-9292.
This Certificate of Authority (CA-1) must be displayed at your place of business.

582-330-410/000

STATE OF NEW JERSEY

Certificate of Authority

DIVISION OF TAXATION
TRENTON, N.J. 08646

The person, partnership or corporation named below is hereby authorized to collect
NEW JERSEY SALES & USE TAX

pursuant to N.J.S.A. 54:32B-1 ET SEQ.

This authorization is good ONLY for the named person at the location specified herein.
This authorization is null and void if any change of ownership or address is effected.

FIELDTURF USA INC.
175 N. INDUSTRIAL BLVD
CALHOUN GA 30701

Tax Registration No: XXX-XXX-410/000
Tax Effective Date: 09-30-02
Document Locator No.: C0000005577
Date Issued: 06-25-13

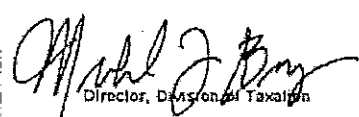
 Director, Division of Taxation

This Certificate is NOT assignable or transferable. It must be conspicuously displayed at above address.

Certificate Number
631021

Registration Date: 06/18/2013
Expiration Date: 06/17/2015



State of New Jersey

Department of Labor and Workforce Development Division of Wage and Hour Compliance

Public Works Contractor Registration Act

Pursuant to N.J.S.A. 34:11-56.48, et seq. of the Public Works Contractor Registration Act, this certificate of registration is issued for purposes of bidding on any contract for public work or for engaging in the performance of any public work to:

2013
Fieldrun USA Inc

Responsible Representative(s):

Eric Dalere, President
Souha Azar, Secretary
Marie-France Nantel, Secretary
Alain Tanguay, CFO

Responsible Representative(s):

Harold J. Wirths, Commissioner
Department of Labor and Workforce Development

NON TRANSFERABLE

This certificate may not be transferred or assigned and may be revoked for cause by the Commissioner of Labor and Workforce Development.

(REVISED 4/13)

EXHIBIT A
MANDATORY EQUAL EMPLOYMENT OPPORTUNITY LANGUAGE
N.J.S.A. 10:5-31 et seq. (P.L. 1975, C. 127)
N.J.A.C. 17:27

GOODS, PROFESSIONAL SERVICE AND GENERAL SERVICE CONTRACTS

During the performance of this contract, the contractor agrees as follows:

The contractor or subcontractor, where applicable, will not discriminate against any employee or applicant for employment because of age, race, creed, color, national origin, ancestry, marital status, affectional or sexual orientation, gender identity or expression, disability, nationality or sex. Except with respect to affectional or sexual orientation and gender identity or expression, the contractor will ensure that equal employment opportunity is afforded to such applicants in recruitment and employment, and that employees are treated during employment, without regard to their age, race, creed, color, national origin, ancestry, marital status, affectional or sexual orientation, gender identity or expression, disability, nationality or sex. Such equal employment opportunity shall include, but not be limited to the following: employment, upgrading, demotion, or transfer; recruitment or recruitment advertising; layoff or termination; rates of pay or other forms of compensation; and selection for training, including apprenticeship. The contractor agrees to post in conspicuous places, available to employees and applicants for employment, notices to be provided by the Public Agency Compliance Officer setting forth provisions of this nondiscrimination clause.

The contractor or subcontractor, where applicable will, in all solicitations or advertisements for employees placed by or on behalf of the contractor, state that all qualified applicants will receive consideration for employment without regard to age, race, creed, color, national origin, ancestry, marital status, affectional or sexual orientation, gender identity or expression, disability, nationality or sex.

The contractor or subcontractor will send to each labor union, with which it has a collective bargaining agreement, a notice, to be provided by the agency contracting officer, advising the labor union of the contractor's commitments under this chapter and shall post copies of the notice in conspicuous places available to employees and applicants for employment.

The contractor or subcontractor, where applicable, agrees to comply with any regulations promulgated by the Treasurer pursuant to N.J.S.A. 10:5-31 et seq., as amended and supplemented from time to time and the Americans with Disabilities Act.

The contractor or subcontractor agrees to make good faith efforts to meet targeted county employment goals established in accordance with N.J.A.C. 17:27-5.2.

EXHIBIT A (Continuation)

The contractor or subcontractor agrees to inform in writing its appropriate recruitment agencies including, but not limited to, employment agencies, placement bureaus, colleges, universities, and labor unions, that it does not discriminate on the basis of age, race, creed, color, national origin, ancestry, marital status, affectional or sexual orientation, gender identity or expression, disability, nationality or sex, and that it will discontinue the use of any recruitment agency which engages in direct or indirect discriminatory practices.

The contractor or subcontractor agrees to revise any of its testing procedures, if necessary, to assure that all personnel testing conforms with the principles of job-related testing, as established by the statutes and court decisions of the State of New Jersey and as established by applicable Federal law and applicable Federal court decisions.

In conforming with the targeted employment goals, the contractor or subcontractor agrees to review all procedures relating to transfer, upgrading, downgrading and layoff to ensure that all such actions are taken without regard to age, race, creed, color, national origin, ancestry, marital status, affectional or sexual orientation, gender identity or expression, disability, nationality or sex, consistent with the statutes and court decisions of the State of New Jersey, and applicable Federal law and applicable Federal court decisions.

The contractor shall submit to the public agency, after notification of award but prior to execution of a goods and services contract, one of the following three documents:

Letter of Federal Affirmative Action Plan Approval

Certificate of Employee Information Report

Employee Information Report Form AA302 (electronically provided by the Division and distributed to the public agency through the Division's website at www.state.nj.us/treasury/contract_compliance)

The contractor and its subcontractors shall furnish such reports or other documents to the Division of Purchase & Property, CCAU, EEO Monitoring Program as may be requested by the office from time to time in order to carry out the purposes of these regulations, and public agencies shall furnish such information as may be requested by the Division of Purchase & Property, CCAU, EEO Monitoring Program for conducting a compliance investigation pursuant to Subchapter 10 of the Administrative Code at N.J.A.C. 17:27.

The undersigned vendor certifies on their company's receipt, knowledge and commitment to comply with

EXHIBIT A
N.J.S.A. 16:5-31 and N.J.A.C. 17:27
MANDATORY EQUAL EMPLOYMENT OPPORTUNITY LANGUAGE
Goods, Professional Services and General Services Contracts
(Mandatory Affirmative Action Language)

The undersigned vendor further agrees to furnish the required forms of evidence and

understands that their contract/company's bid shall be rejected as non-responsive if said contractor fails to comply with the requirements of N.J.S.A. 16:5-31 and N.J.A.C. 17:27.

Representative's Name/Title (Print): Alvin Turkey, CFO

Representative's Signature: [Signature]

Name of Company: FieldTurf USA, Inc.

Tel. No.: 514-375-2603 Date: 3/2/2014



Sample Employee Information Report Form AA302

Form AA302
Rev. 1/11/11

STATE OF NEW JERSEY
Division of Purchases & Property
Contract Compliance Audit Unit
RED Monitoring Programs

EMPLOYEE INFORMATION REPORT

IMPORTANT: READ THE INSTRUCTIONS CAREFULLY BEFORE COMPLETING THIS FORM TO PREVENT OMISSIONS. OMISSIONS MAY CAUSE THE REPORT TO BE REJECTED. FAILURE TO PREPARE CORRECTLY THIS FORM MAY CAUSE THE REPORT TO BE REJECTED. FAILURE TO PREPARE CORRECTLY THIS FORM MAY CAUSE THE REPORT TO BE REJECTED. FAILURE TO PREPARE CORRECTLY THIS FORM MAY CAUSE THE REPORT TO BE REJECTED.

SECTION A - COMPANY IDENTIFICATION

1. Fed. No. OR SOCIAL SECURITY: 2. TYPE OF BUSINESS: 1. MFG. 2. RETAIL 3. SERVICE 4. WHOLESALE 5. OTHER

3. COMPANY NAME: FieldTurf USA, Inc.

4. ADDRESS: 7445 Col-de-Liesse Rd. CITY: Montreal COUNTY: Canada STATE: QC ZIP CODE: H4T 1G2

5. TYPE OF CONTRACT: 1. SINGLE CONTRACT 2. MULTIPLE CONTRACTS

6. NAME OF CONTRACTOR OR SUPPLIER: FieldTurf USA, Inc. CITY: Montreal COUNTY: Canada STATE: QC ZIP CODE: H4T 1G2

SECTION B - EMPLOYEE DATA

1. Report all personnel, temporary and part-time employees ON YOUR OWN PAYROLL. Do not include agency employees, leased employees, or employees of other contractors.

JOB CATEGORIES	ALL EMPLOYEES			EMPLOYEES BY ETHNICITY									
	WHITE	BLACK	OTHER	WHITE	BLACK	ASIAN	HISPANIC	INDIAN	AMERICAN INDIAN	ALASKAN	NATIVE HAWAIIAN	OTHER	NEW HIRE
Professionals	4	4	0	0	0	0	0	0	0	0	0	0	0
Technicians		12	0	0	0	0	0	0	0	0	0	0	5
Skilled Workers													
Office & Clerical													
Craftworkers (skilled)													
Operatives (skilled)													
Laborers (skilled)													
Skilled Workers													
TOTAL													
Total Employment													
Part-time													
Temporary/Seasonal													

See attached

12. HOW WAS INFORMATION OBTAINED BASED ON STATE OF NEW JERSEY CONTRACT COMPLIANCE ACT? 1. Vendor Survey 2. Employer Report 3. Other Source

13. DATE OF PAYROLL PERIOD USED FROM: 8/25/2013 TO: 8/31/2013

14. IS THIS THE FIRST REPORT SUBMITTED? 1. YES 2. NO

15. DATE LAST REPORT SUBMITTED: NO. DAY YEAR: 9/30/2013

16. NAME OF PERSON COMPLETING FORM (Name or Title): Celestina Gagnon SIGNATURE: [Signature] TITLE: HR DATE: 09/02/2014

17. ADDRESS NO. A STREET: 7445 Col-de-Liesse, suite CITY: Montreal COUNTY: QC STATE: QC ZIP CODE: H4T 1G2

Form Duplicate Cert. Rev. 3/10



STATE OF NEW JERSEY DEPARTMENT OF THE TREASURY Division of Public Contracts Equal Employment Opportunity Compliance

DUPLICATE CERTIFICATE OF EMPLOYEE INFORMATION REPORT REQUEST

IMPORTANT- FAILURE TO PROPERLY COMPLETE THE ENTIRE FORM AND SUBMIT THE REQUIRED \$75.00 FEE (Non-Refundable) MAY DELAY ISSUANCE OF YOUR DUPLICATE CERTIFICATE OF EMPLOYEE INFORMATION REPORT.

SECTION A - COMPANY IDENTIFICATION

1. FED. NO. OR SOCIAL SECURITY 2. ASSIGNED CERTIFICATE NUMBER 34146 ISSUE DATE 07/15/23 EXPIRATION DATE 03/15/16

3. COMPANY NAME FieldTurf USA, Inc.

4. STREET 7445 Cole-de-Lesse Rd CITY Montreal COUNTY Canada STATE QC ZIP CODE H4T 1G2

5. REASON FOR REQUEST OF DUPLICATE CERTIFICATE [] 1. Lost Certificate [] 2. Damaged [X] 3. Other (Specify) First Request

6. NAME OF PERSON COMPLETING FORM (Print or Type) Alan Langley SIGNATURE TITLE CFO DATE 7 | 2 | 14

7. ADDRESS NO. & STREET 7445 Cole-de-Lesse Rd CITY Montreal COUNTY Canada STATE QC ZIP CODE H4T 1G2 PHONE (AREA CODE, NO., EXTENSION) 1-514-875-2603

I certify that the information on this Form is true and correct.

SECTION C - OFFICIAL USE ONLY RECEIVED DATE DIVISION OF REVENUE DISC.

INSTRUCTIONS FOR COMPLETING DUPLICATE CERTIFICATE REQUEST

- ITEM 1 - Enter the Federal Identification Number assigned by the Internal Revenue Service... ITEM 2 - Enter the Certificate Number that was assigned to your company... ITEM 3 - Enter the name by which the company is identified... ITEM 4 - Enter the physical location of the company... ITEM 5 - Enter the reason for requesting a Duplicate Certificate of Employee Information Report... ITEM 6 - Print or type the name of the person completing the form... ITEM 7 - Enter the physical location where the form is being completed...

RETAIN A COPY OF THIS REQUEST FOR THE VENDOR'S OWN FILES AND FORWARD ONE COPY WITH A CHECK IN THE AMOUNT OF \$75.00 (Non-Refundable Fee) PAYABLE TO THE TREASURER, STATE OF NEW JERSEY TO:

NJ Department of the Treasury - Division of Public Contracts Equal Employment Opportunity Compliance PO Box 206 Trenton, New Jersey 08635-0206 Telephone No. (609) 292-5473

PLEASE ALLOW 15 BUSINESS DAYS FOR PROCESSING THE DUPLICATE CERTIFICATE

APPENDIX A
AMERICANS WITH DISABILITIES ACT OF 1990
Equal Opportunity for Individuals with Disability

The contractor and the _____ of _____ (hereafter "owner") do hereby agree that the provisions of Title II of the Americans With Disabilities Act of 1990 (the "Act") (42 U.S.C. 5121 01 et seq.), which prohibits discrimination on the basis of disability by public entities in all services, programs, and activities provided or made available by public entities, and the rules and regulations promulgated pursuant thereto, are made a part of this contract. In providing any aid, benefit, or services on behalf of the owner pursuant to this contract, the contractor agrees that the performance shall be in strict compliance with the Act. In the event that the contractor, its agents, servants, employees, or subcontractors violate or are alleged to have violated this Act during the performance of this contract, the contractor shall defend the owner in any action or administrative proceeding commenced pursuant to this Act. The contractor shall indemnify, protect, and save harmless the owner, its agents, servants, and employees from and against any and all suits, claims, losses, demands, or damages, of whatever kind or nature arising out of or claimed to arise out of the alleged violation. The contractor shall, at its own expense, appear, defend, and pay any and all charges for legal services and any and all costs and other expenses arising from such action or administrative proceeding or incurred in connection therewith. In any and all complaints brought pursuant to the owner's grievance procedure, the contractor agrees to abide by any decision of the owner which is rendered pursuant to said grievance procedure. If any action or administrative proceeding results in an award of damages against the owner, or if the owner incurs any expense to cure a violation of the ADA which has been brought pursuant to its grievance procedure, the contractor shall satisfy and discharge the same at its own expense.

The owner shall, as soon as practicable after a claim has been made against it, give written notice thereof to the contractor along with full and complete particulars of the claim. If any action or administrative proceeding is brought against the owner or any of its agents, servants, and employees, the owner shall expeditiously forward or have forwarded to the contractor every demand, complaint, notice, summons, pleading, or other process received by the owner or its representatives.

It is expressly agreed and understood that any approval by the owner of the services provided by the contractor pursuant to this contract will not relieve the contractor of the obligation to comply with the Act and to defend, indemnify, protect, and save harmless the owner pursuant to this paragraph.

It is further agreed and understood that the owner assumes no obligation to indemnify or save harmless the contractor, its agents, servants, employees and subcontractors for any claim which may arise out of their performance of this Agreement. Furthermore, the contractor expressly understands and agrees that the provisions of this indemnification clause shall in no way limit the contractor's obligations assumed in this Agreement, nor shall they be construed to relieve the contractor from any liability, nor preclude the owner from taking any other actions available to it under any other provisions of the Agreement or otherwise at law.

Representative's Name/Title Print: Alan Johnson (FD)
Representative's Signature: [Signature]
Name of Company: FieldTurf USA, Inc.
Tel. No.: 514-233-2570 Date: 7/1/2014

Minority/Woman Business Enterprise (MWBE)
Questionnaire for Bidders

Jersey City Ordinance C-829 establishes a goal of awarding 20% of the dollar amount of total city procurement to minority and woman owned business enterprises.

To assist us in monitoring our achievement of this goal, please indicate below whether your company is or is not a minority owned and/or woman owned business, and return this form with your bid proposal.

Business Name : Fieldturf USA, Inc.
Address : 7445 Lake-de-lake Road, Suite 200 Montreal, QC H4T 1G2 Canada.
Telephone No. : 1 (514) - (375) - 2603
Contact Name : Ju Lie Mailhot

Please check applicable category :

Minority Owned Business (MBE) Minority & Woman Owned Business (MWBE)
 Woman Owned business (WBE) Neither

Definitions

Minority Business Enterprise

Minority Business Enterprise means a business which is a sole proprietorship, partnership or corporation at least 51% of which is owned and controlled by persons who are African American, Hispanic, Asian American, American Indian or Alaskan native, defined as follows:

African American: a person having origins in any of the black racial groups of Africa

Hispanic: a person of Mexican, Puerto Rican, Central or South American or other non-European Spanish culture or origin regardless of race.

Asian: a person having origins in any of the original peoples of the Far East, South East Asia, Indian subcontinent, Hawaii or the Pacific Islands.

American Indian or Alaskan Native: a person having origins in any of the original peoples of North America and who maintains cultural identification through tribal affiliation or community recognition.

Woman Business Enterprise

Woman Business Enterprise means a business which is a sole proprietorship, partnership or corporation at least 51% of which is owned and controlled by a woman or women.

OFFICE OF EQUAL OPPORTUNITY COPY

OF EB50448
 OF EB50448

EQUAL EMPLOYMENT OPPORTUNITY
 2013 EMPLOYER INFORMATION REPORT
 CONSOLIDATED REPORT - TYPE 2

SECTION B - COMPANY IDENTIFICATION

1. FIELDTURF USA INC.
 175 N. INDUSTRIAL BOULEVARD NE
 CALHOUN, GA 30701

2a. FIELDTURF USA INC.
 175 N. INDUSTRIAL BOULEVARD NE
 CALHOUN, GA 30701

SECTION C - TEST FOR FILING REQUIREMENT

1-Y 2-Y 3-Y DUNS NO.:131862364

SECTION E - ESTABLISHMENT INFORMATION

NAICS:

SECTION D - EMPLOYMENT DATA

JOB CATEGORIES	HISPANIC OR LATINO		NOT-HISPANIC OR LATINO											OVERALL TOTALS		
	MALE	FEMALE	***** MALE *****						***** FEMALE *****							
			WHITE	BLACK OR AFRICAN AMERICAN	NATIVE HAWAIIAN OR PACIFIC ISLANDER	ASIAN	AMERICAN INDIAN OR ALASKAN NATIVE	TWO OR MORE RACES	WHITE	BLACK OR AFRICAN AMERICAN	NATIVE HAWAIIAN OR PACIFIC ISLANDER	ASIAN	AMERICAN INDIAN OR ALASKAN NATIVE		TWO OR MORE RACES	
EXECUTIVE/SR OFFICIALS & MGRS	0	0	4	0	0	0	0	0	0	0	0	0	0	0	0	4
FIRST/MID OFFICIALS & MGRS	0	1	12	0	0	0	0	0	5	0	0	0	0	0	0	18
PROFESSIONALS	0	0	8	0	0	1	0	0	2	0	0	0	0	0	0	11
TECHNICIANS	0	0	2	0	0	0	0	0	2	0	0	0	0	0	0	4
SALES WORKERS	0	0	28	0	0	0	0	0	0	0	0	0	0	0	0	28
ADMINISTRATIVE SUPPORT	0	0	5	0	0	0	0	0	13	1	0	0	0	0	0	19
CRAFT WORKERS	27	0	29	0	1	0	0	0	2	0	0	0	0	0	0	59
OPERATIVES	3	0	16	1	0	0	0	0	2	0	0	0	0	0	0	22
LABORERS & HELPERS	1	0	14	0	0	0	0	0	3	1	0	0	0	0	0	19
SERVICE WORKERS	0	0	0	0	0	0	0	0	0	0	0	0	0	0	0	0
TOTAL	31	1	118	1	1	1	0	0	29	2	0	0	0	0	0	184
PREVIOUS REPORT TOTAL	32	1	131	3	0	0	0	0	33	1	0	0	0	0	0	201

SECTION F - REMARKS

DATES OF PAYROLL PERIOD: 08/25/2013 THRU 08/31/2013

SECTION G - CERTIFICATION

CERTIFYING OFFICIAL: KARINA CAMPOS
 EEO-1 REPORT CONTACT PERSON: CELESTINA GAGLIANO
 EMAIL: celestina.gagliano@fieldturf.com

TITLE: HR MANAGER
 TITLE: HR
 TELEPHONE NO: 5143752581

CERTIFIED DATE[EST]: 09/30/2013 04:31 PM

Resolution of the City of Jersey City, N.J.

City Clerk File No. Res. 14.496

Agenda No. 10.Z.3

Approved: JUL 16 2014

TITLE:



RESOLUTION AUTHORIZING THE AWARD OF CONTRACT TO AJM CONTRACTORS INC FOR RESURFACING OF VARIOUS STREETS FOR YEAR 2014, PROJECT NO. E14-003 FOR THE DEPARTMENT OF PUBLIC WORKS /DIVISION OF ARCHITECTURE, ENGINEERING AND TRAFFIC TRANSPORTATION

**COUNCIL
OFFERED AND MOVED ADOPTION OF THE FOLLOWING RESOLUTION:**

WHEREAS, the City's Purchasing Director acting within his authority and in conformity with N.J.S.A. 40A:11-1 et. seq. has publicly advertised bids for **Resurfacing of Various streets for Year 2014, Project No. E14-003** for the Department of Public Works/Div. of Architecture, Engineering, Traffic and Transportation pursuant to specifications and bids thereof; and

WHEREAS, pursuant to public advertisement the City of Jersey City has received **Four (4) Bids**, the lowest responsible bid being that from **AJM Alexander Inc.** 300 Kuller Road, Clifton, NJ 07011, in the total bid amount of **One Million, Two Hundred Twenty Five Thousand, Nine Hundred One (\$1,225,901.29) Dollars and Twenty Nine cents**; and

WHEREAS, the City's Purchasing Director has certified that he considers said bid to be fair and reasonable; and

WHEREAS, the sum of **One Million, Two Hundred Twenty Five Thousand, Nine Hundred One (\$1,225,901.29) Dollars and Twenty Nine cents**, are available in the 2014 temporary and permanent budget; and

WHEREAS, the funds for this purchase are available in **State Grant Acct #02-213-40-285-314** and **City Capital Acct #04-215-55-903-991**; and

Dept. of Public Works/Div. of Architecture, Engineering, Traffic & Transportation.

Acct. No.	P.O. #		Amount
02-213-40-285-314	114097	State Grant Acct	\$1,225,901.29
		Base Bid Total	
04-215-55-903-991	114098	City Capital Acct (Police Hrs)	\$120,000.00
		Total Encumbrance	\$1,345,901.29

WHEREAS, these funds are available for this expenditure in accordance with requirements of the Local Budget Law, N.J.S.A. 40A:4-1 et. Seq.

WHEREAS, if funds are not available for the contract in the 2014 temporary and permanent budgets, the contract will be terminated.

NOW, THEREFORE, BE IT RESOLVED, by the Municipal Council of the City of Jersey City that the said bid of the aforementioned **AJM Contractors Inc.** be accepted and that a contract be awarded to said company in the above amount, and the Director of Purchasing is directed to have such a contract drawn up and executed; and be it further

RESOLVED, that upon certification by an official or employee of the City authorized to receive the material pursuant to the contract, that the same has been received and that the requirements of the contract met, then; payment to the contractor shall be made in accordance with the provisions of the Local Fiscal Affairs Law, N.J.S.A. 40A:5-1 et. seq; and be it further

(Continued on page 2)

TITLE:

RESOLUTION AUTHORIZING THE AWARD OF CONTRACT TO AJM CONTRACTORS INC FOR RESURFACING OF VARIOUS STREETS FOR YEAR 2014, PROJECT NO. E14-003 FOR THE DEPARTMENT OF PUBLIC WORKS /DIVISION OF ARCHITECTURE, ENGINEERING AND TRAFFIC TRANSPORTATION

RESOLVED, this contract shall be subject to the condition that the vendor/contractor provide satisfactory evidence of compliance with the Affirmative Action Amendments to the Law Against Discrimination, N.J.S.A. 10:5-31 et. seq.; and be it further

RESOLVED, that the Mayor or Business Administrator is hereby authorized to execute a contract on behalf of the City of Jersey City.

I, Donna Mauer, Donna Mauer, Chief Financial Officer, certify that there are sufficient funds available for payment of this above resolution in account shown below.

Dept. of Public Works/Div. of Architecture, Engineering, Traffic & Transportation.

Acct. No.	P.O. #		Amount
02-213-40-285-314	114097	State Grant Acct Base Bid Total	\$1,225,901.29
04-215-55-903-991	114098	City Capital Acct (Police Hrs) Total Encumbrance	\$120,000.00 \$1,345,901.29

Approved by Raquel Sorado, PPS
for Peter Polgado, Director of Purchasing, QPA

APPROVED: [Signature]
Business Administrator
APST

APPROVED AS TO LEGAL FORM
[Signature]
Corporation Counsel
Certification Required

Not Required APPROVED 9-0

RECORD OF COUNCIL VOTE ON FINAL PASSAGE 7.16.14											
COUNCILPERSON	AYE	NAY	N.V.	COUNCILPERSON	AYE	NAY	N.V.	COUNCILPERSON	AYE	NAY	N.V.
GAJEWSKI	✓			YUN	✓			RIVERA	✓		
RAMCHAL	✓			OSBORNE	✓			WATTERMAN	✓		
BOGGIANO	✓			COLEMAN	✓			LAVARRO, PRES.	✓		

✓ Indicates Vote

N.V.-Not Voting (Abstain)

Adopted at a meeting of the Municipal Council of the City of Jersey City N.J.

[Signature]
Rolando R. Lavarro, Jr., President of Council

[Signature]
Robert Byrne, City Clerk

RESOLUTION FACT SHEET - CONTRACT AWARD

This summary sheet is to be attached to the front of any resolution that is submitted for Council consideration. Incomplete or vague fact sheets will be returned with the resolution.

Full Title of Ordinance/Resolution

RESOLUTION AWARDED CONTRACT TO AJM CONTRACTORS, INC. FOR THE RESURFACING OF VARIOUS STREETS FOR YEAR 2014, PROJECT NO: E14-003 FOR THE DEPARTMENT OF PUBLIC WORKS, DIVISION OF ARCHITECTURE, ENGINEERING, TRAFFIC AND TRANSPORTATION

Project Manager

Department/Division	DPW	Architecture, Engineering, Traffic
Name/Title	Stanley Huang, Municipal Engineer	
Phone/email	201-547-4411	stanley@icnj.org

Note: Project Manager must be available by phone during agenda meeting (Wednesday prior to council meeting @ 4:00 p.m.)

This project involves improvements to various streets in Jersey City. Specifically, the work will involve milling, paving, traffic striping, new or replacement of obsolete or deteriorating catch basins, manholes and water valve box castings, construction of concrete curb and sidewalk (charcoal gray in historic areas) with handicapped curb ramps with detectable warning surfaces at intersections

Cost (Identify all sources and amounts)

Contract term (include all proposed renewals)

NJDOT Grant Account: 02-213-40-285-314	
R: 0165221 Base Bid Amount	\$1,225,901.29
City/Eng Capital Account: 04-215-55-903-991	
R: 0165222 Police Hours Amount	\$120,000.00
TOTAL ENCUMBRANCE	\$1,345,901.29

Term: 120 Calendar Days after issuance of Notice to Proceed

Type of award

If "Other Exception", enter type

Additional Information

The awarding resolution has been drafted by the Division of Purchasing. This is a public bid. They were FOUR (4) bidders:

AJM CONTRACTORS, INC.	Clifton NJ	Base Bid Total	\$1,225,901.29
SMITH-SONDY	Wallington, NJ	Base Bid Total	\$1,364,604.26
J.A. ALEXANDER	Bloomfield, NJ	Base Bid Total	\$1,346,269.48
TILCON, NEW YORK	Wharton, NJ	Base Bid Total	\$1,474,411.10

I certify that all the facts presented herein are accurate.

Signature of Department Director

7/3/14
Date



**CITY OF JERSEY CITY
DEPARTMENT OF PUBLIC WORKS**

PUBLIC WORKS COMPLEX | 575 ROUTE 440 | JERSEY CITY, NJ 07305
P: 201 547 4402 | F: 201 547 4803



STEVEN M. FULOP
MAYOR OF JERSEY CITY

MICHAEL E. RAZZOLI
DIRECTOR

MEMORANDUM

Date: July 3, 2014
To: Peter Folgado, Purchasing Director
From: Michael Razzoli , DPW Director
Subject : Recommendation Letter (Resurfacing of various streets)

Please be advised. after a careful and thorough review of bids received for resurfacing of various streets. I recommend that the contract be awarded to:

**A.J.M. CONTRACTORS INC.
300 KULLER RD
CLIFTON, NJ 07011**

Total contract Amount = \$1,345,901.29

Please proceed and utilize the following requisitions listed below. Kindly draft the awarding resolution for the July 16th Council meeting.

REQ #	ACCOUNT NUMBER	AMOUNT
0165221	02-213-40-285-314(State Grant)	\$1,225,901.29
0165222	04-215-55-903-991 (Street Resurfacing Capital)	\$120,000.00
	TOTAL	\$1,345,901.29

Should you have any questions or need any additional justifications regarding this contract award, please do not hesitate to call my office at X 4400/01.

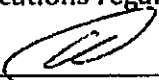
Michael Razzoli

- C: Raquel Tosado, Contracts Manager
James Madden, DPW Deputy Director
Brian Weller, Director of Arch, Eng. & Traffic
Hector Ortiz, Deputy Director of Operations
Stanley Huang, Municipal Engineer
Bhavini Doshi, Confidential Aide, DPW Director's Office
Dawn Odom, Supvr. Adm. Analyst

Vipul Patel, Senior Engineer
Zakta Gregory, DPW Fiscal Office
Paola Campbell, Purchasing Division



STEVEN M. FULOP
MAYOR OF JERSEY CITY

CITY OF JERSEY CITY
DEPARTMENT OF PUBLIC WORKS
PUBLIC WORKS COMPLEX | 575 ROUTE 440 | JERSEY CITY, NJ 07305
P: 201 547 4402 | F: 201 547 4803



MICHAEL E. RAZZOLI
DIRECTOR

MEMORANDUM

Date: July 3, 2014
To: Michael E. Razzoli, Director, Department of Public Works
From: Brian F. Weller, Division Director, Architecture, Engineering & Traffic 
Subject: Award Recommendation
Resurfacing of Various Streets for the Year 2014
Project No. E-14-003

=====

Please be advised, after careful and thorough review of the bids received for the above-referenced project, I recommend that the contract be awarded to: **AJM Contractors, Inc., 300 Kuller Road, Clifton, NJ 07011** in the total base bid amount of **\$1,225,901.29**

Please proceed and utilize the following requisitions listed below. Kindly draft the awarding resolution to be presented at the July 16th, 2014 Council Meeting.

REQ. #	ACCOUNT #	AMOUNT
0165221	02-213-40-285-314 (State Grant)	\$1,225,901.29
0165222	04-215-55-903-991 (City Capital-Police)	\$120,000.00
		=====
	TOTAL:	\$1,345,901.29

Should you have any questions or need any additional justifications, please do not hesitate to contact this office at Ext. 4400.

cc: James Madden, DPW Deputy Director
Bhavini Doshi, Esq., Confidential Aide, DPW Director's Office
Stanley Huang, P.E. Municipal Engineer
Dawn Odom, Supervising Admin. Analyst
Vipul Patel, Project Manager, Senior Engineer

YEAR 2014

LIST OF STREETS TO BE RESURFACED (NJDOT STATE FUND)

NO	STREET	FROM	TO
1	Pearsall Ave	J F K Blvd	Ocean Ave
2	Gates Ave	Princeton Ave	Old Bergen Ave
3	North St	Central Ave	Palisade Ave
4	Van Horne St	Bramhall Av	Lafayette St
5	Summit Ave	Clifton Pl	Communipaw Ave
6	Bostwick Ave	M L K Drive	Ocean Ave
7-ALT	Westervelt Pl	Cornellson	Grand St
8-ALT	Hutton St	Palisade Ave	Sherman Ave
Approximate Total Length=12,475 LF (APPROXIMATE 2.40 MILE)			

NOTE: IT IS UNDERSTOOD THAT THE STREETS INDICATED IN THE TABLE ABOVE MAY BE SUBJECT TO CHANGE AS DIRECTED BY THE FIELD ENGINEER.

DUE TO BUDGET RESTRAINTS THE ALTERNATE STREETS 7-ALTERNATE A AND 8-ALTERNATE B MAY/MAY NOT BE INCLUDED IN THIS CONTRACT.



A.J.M. CONTRACTORS, INC.



**300 Kuller Road
Clifton, NJ 07011
(973)- 772-9292
FAX: (973)-772-9222**

GENERAL BUSINESS REFERENCES

- 1. TILCON MATERIALS OF NEW YORK
625 MT. HOPE ROAD
WHARTON, NJ
(800)-789-7625
Fax: (973)-659-3867
SALESPERSON: FRANK DELGUERCIO: 201-832-5672**

- 2. NEWARK ASPHALT
FOOT OF PASSAIC STREET
NEWARK, NJ
(973)-482-3503
FAX: (973)-268-3639
SALESPERSON: JOE BIGGLIO: 973-414-1392**

- 3. WELDON MATERIALS
141 CENTRAL AVENUE
WESTFIELD, NJ
(908)-233-4444
FAX: (908)- 233-4215
CONTACT: ACCOUNTS**



300 Kuller Road
Clifton, NJ 07011
(973)- 772-9292
FAX: (973)-772-9222

BANK REFERENCE FOR AJM CONTRACTORS

VALLEY NATIONAL BANK
UNION BLVD.
TOTOWA, NJ

CONTACT: TOBY GIARDELLO 1-862-261-3029

ACCT. # 1129023

SCHEDULE OF PRICES

ITEM NO. 1 NO ITEM

ITEM NO. 2 BREAKAWAY BARRICADES

\$ 80.⁰⁰

8 Units @ \$ 10.⁰⁰ per Ton
TEN DOLLARS

(Write Unit Price)

ITEM NO. 3 TRAFFIC DRUM

\$ 80.⁰⁰

8 Units @ \$ 10.⁰⁰ per Unit

TEN DOLLARS

(Write Unit Price)

ITEM NO. 4 TRAFFIC CONE

\$ 400.⁰⁰

8 Units @ \$ 50.⁰⁰ per Unit

FIFTY DOLLARS

(Write Unit Price)

ITEM NO. 5 CONSTRUCTION SIGNS

\$ 800.⁰⁰

16 S.F. @ \$ 50.⁰⁰ per Square Foot

FIFTY DOLLARS

(Write Unit Price)

ITEM NO. 6 CONSTRUCTION IDENTIFICATION SIGN (48" x 48") \$ 500.00

1 Units @ \$ 500. per Unit
Five hundred dollars.
(Write Unit Price)

ITEM NO. 7 TEMPORARY PAVEMENT MARKERS \$ 154.00

77 Units @ \$ 2.00 per Unit
TWO DOLLARS
(Write Unit Price)

ITEM NO. 8 TEMPORARY TRAFFIC STRIPES, 4" WIDE \$ 416.50

1,190 L.F. @ \$.35 per Linear Feet
THIRTY FIVE CENTS
(Write Unit Price)

ITEM NO. 9 HMA PATCH \$ 7,700.00

77 Tons @ \$ 100.00 per Ton
ONE HUNDRED DOLLARS
(Write Unit Price)

ITEM NO. 10 TRAFFIC DIRECTOR, FLAGGER. \$.29 ^{HR}

29 Hours @ \$.01 per Hour
ONE CENT
(Write Unit Price)

ITEM NO. 11	TRAFFIC DIRECTOR, JERSEY CITY POLICE 1,547 Hours @ \$ <u>40.00</u> per Hour Forty Dollars and No Cents <hr/> (Write Unit Price)	<u>\$ 61,880.00</u>
ITEM NO. 12	TRAFFIC DIRECTOR, JERSEY CITY POLICE (O.T.RATE, 7:00AM TO 4:00PM) 128 Hours @ \$ <u>57.50</u> per Hour Fifty Seven Dollars and Fifty Cents <hr/> (Write Unit Price)	<u>\$ 7,360.00</u>
ITEM NO. 13	TRAFFIC DIRECTOR, JERSEY CITY POLICE (O.T.RATE + NIGHT DIFFERENTIAL 4:00PM TO 6:00AM) 348 Hour @ \$ <u>67.50</u> per Hour Sixty Seven Dollars and Fifty Cents <hr/> (Write Unit Price)	<u>\$ 23,490.00</u>
ITEM NO. 14	TRAFFIC DIRECTOR, NIGHT TIME JC POLICE (NIGHT DIFFERENTIAL 4:00PM TO 6:00AM) 154 Hour @ \$ <u>50.00</u> per Hour Fifty Dollars and No Cents <hr/> (Write Unit Price)	<u>\$ 7,700.00</u>
ITEM NO. 15	TRAFFIC DIRECTOR, SUPERVISOR, JC POLICE 114 Hours @ \$ <u>50.00</u> per Hour Fifty Dollars and No Cents <hr/> (Write Unit Price)	<u>\$ 5,700.00</u>

ITEM NO. 16	TRAFFIC DIRECTOR, SUPERVISOR, JC POLICE (O.T. RATE AFTER 8 HOURS) 96 Hour @ \$ <u>72.50</u> per Hour <u>Seventy Two Dollars and Fifty Cents</u> (Write Unit Price)	<u>\$ 6,960.00</u>
ITEM NO. 17	TRAFFIC DIRECTOR, SUPERVISOR, JC POLICE (O.T.RATE + NIGHT DIFFERENTIAL 4:00PM TO 6:00AM) 48 Hour @ \$ <u>82.50</u> per Hour <u>Eighty Two Dollars and Fifty Cents</u> (Write Unit Price)	<u>\$ 3,960.00</u>
ITEM NO. 18	TRAFFIC DIRECTOR, NIGHT TIME SUPERVISOR (4:00PM TO 6:00AM) JERSEY CITY POLICE 7 Hour @ \$ <u>60.00</u> per Hour <u>Sixty Dollars and No Cents</u> (Write Unit Price)	<u>\$ 420.00</u>
ITEM NO. 19	POLICE VEHICLE AND FUEL. 19 Hours @ \$ <u>10</u> per Hour <u>Ten Dollars and No Cents</u> (Write Unit Price)	<u>\$ 190.00</u>
ITEM NO. 20	ASPHALT ADJUSTMENT PRICE Lump Sum <u>Five Thousand & No Cents</u> (Write Unit Price)	<u>\$ 5,000.00</u>

- ITEM NO. 21 SAW CUTTING, 10" OR LESS \$ 1,445.00

1445 L.F. @ \$ 1.00 per Linear Foot

ONE DOLLAR

(Write Unit Price)

- ITEM NO. 22 H.M.A MILLING, 3" OR LESS \$ 126,993.75

39,075 S.Y. @ \$ 3.25 per Square Yard

THREE DOLLARS TWENTY FIVE CENTS

(Write Unit Price)

- ITEM NO. 23 HMA PAVEMENT REPAIR \$ 6,000.00

80 Tons @ \$ 75.00 per Ton

SEVENTY FIVE DOLLARS

(Write Unit Price)

- ITEM NO. 24 HMA, 19M64 BASE COURSE \$ 2,200.00

22 Tons @ \$ 100.00 per Ton

ONE HUNDRED DOLLARS

(Write Unit Price)

- ITEM NO. 25 HMA, 12.5M64 SURFACE COURSE \$ 405,299.50

4,973 Tons @ \$ 81.50 per Ton

Eighty one DOLLARS FIFTY CENTS

(Write Unit Price)

ITEM NO. 26

HMA, 12.5H76 SURFACE COURSE

\$ 13,200.00

132 Tons @ \$ 100.00 per Ton

One Hundred Dollars
(Write Unit Price)

ITEM NO. 27

NEW CATCH BASIN, TYPE A

\$ 2,500.00

1 Units @ \$ 2,500 per Unit

Two Thousand Five Hundred Dollars
(Write Unit Price)

ITEM NO. 28

NEW CATCH BASIN, TYPE B

\$ 24,300.00

9 Units @ \$ 2700.00 per Unit

Two Thousand Seven Hundred
(Write Unit Price)

ITEM NO. 29

NEW CATCH BASIN, TYPE E

\$ 2900.00

1 Units @ \$ 2900.00 per Unit

Two Thousand Nine Hundred
(Write Unit Price)

ITEM NO. 30

RECONSTRUCTED CB, TYPE B
USING EXISTING CASTING

\$ 300.00

1 Units @ \$ 300.00 per Unit

THREE Hundred Dollars
(Write Unit Price)

ITEM NO. 31

RECONSTRUCTED CB, TYPE B
USING NEW CASTING

\$ 1,300.⁰⁰

1 Units @ \$ 1,300.⁰⁰ per Unit

ONE THOUSAND THREE HUNDRED DOLLARS
(Write Unit Price)

ITEM NO. 32

REPAIRED CATCH BASIN WALL

\$ 1,440.⁰⁰

240 S.F. @ \$ 6.⁰⁰ per Square Foot

Six Dollars
(Write Unit Price)

ITEM NO. 33

CATCH BASIN CASTING, TYPE B

\$ 5,400.⁰⁰

6 Units @ \$ 900.⁰⁰ per Unit

Nine Hundred Dollars.
(Write Unit Price)

ITEM NO. 34

CATCH BASIN CASTING, TYPE E

\$ 990.⁰⁰

1 Units @ \$ 990.⁰⁰ per Unit

Nine hundred ninety Dollars.
(Write Unit Price)

ITEM NO. 35

CAST IRON CURB PIECE TYPE N, 4" HIGH

\$ 4,200.⁰⁰

14 Units @ \$ 300.⁰⁰ per Unit

THREE HUNDRED DOLLARS
(Write Unit Price)

ITEM NO. 36

CAST IRON CURB PIECE TYPE N, 6" HIGH

\$ 2,100.00

9 Units @ \$ 300.00 per Unit

THREE HUNDRED DOLLARS
(Write Unit Price)

ITEM NO. 37

CAST IRON CURB PIECE TYPE N, 8" HIGH

\$ 3,600.00

12 Units @ \$ 300.00 per Unit

THREE HUNDRED DOLLARS
(Write Unit Price)

ITEM NO. 38

BICYCLE SAFE GRATE, 21³/₄" x 47³/₄"

\$ 2,700.00

9 Units @ \$ 300.00 per Unit

THREE HUNDRED DOLLARS
(Write Unit Price)

ITEM NO. 39

DRIVEWAY ACCESS BACK PLATE

\$ 700.00

1 Units @ \$ 700.00 per Unit

seven hundred dollars
(Write Unit Price)

ITEM NO. 40

CATCH BASIN TRAP

\$ 2,500.00

5 Units @ \$ 500.00 per Unit

five hundred dollars
(Write Unit Price)

ITEM NO. 41

CATCH BASIN WALL PLATE

\$ 2500.00

5 Units @ \$ 500.00 per Unit

Five Hundred Dollars
(Write Unit Price)

ITEM NO. 42

RESET EXISTING CASTINGS

\$ 1,200.00

6 Units @ \$ 200.00 per Unit

Two Hundred Dollars
(Write Unit Price)

ITEM NO. 43

RESET JUNCTION BOX CASTING

\$ 500.00

1 Units @ \$ 500.00 per Unit

Five Hundred Dollars
(Write Unit Price)

ITEM NO. 44

RELOCATE JUNCTION BOX

\$ 6,000.00

3 Units @ \$ 2000.00 per Unit

Two Thousand Dollars
(Write Unit Price)

ITEM NO. 45

MAHOLE CASTING, CATLOG NO:1007D

\$ 32,550.00

62 Units @ \$ 525.00 per Unit

Five hundred twenty five dollars
(Write Unit Price)

ITEM NO. 46

MAHOLE CASTING, CATLOG NO:1012B
WITH 4428 COVER

\$ 2,400.

2 Units @ \$ 1,200.00 per Unit

Two thousand dollars
(Write Unit Price)

ITEM NO. 47

DENSE GRADED AGGREGATE BACKFILL

\$ 3,000.

150 Tons @ \$ 20.00 per Ton

Twenty dollars
(Write Unit Price)

ITEM NO. 48

12" DIP CLASS 52 (IF AND WHERE WERE DIRECTED)

\$ 2340.00

18 L.F. @ \$ 130.00 per Linear Foot

One thousand Three hundred
(Write Unit Price)

ITEM NO. 49

16" DIP CLASS 52 (IF AND WHERE WERE DIRECTED)

\$ 17,110.00

118 L.F. @ \$ 145.00 per Linear Foot

One thousand four hundred fifty
(Write Unit Price)

ITEM NO. 50

CONCRETE SIDEWALK, 4" THICK

\$ 162,500.

2,500 S.Y. @ \$ 65.00 per Square Yard

Sixty five dollars
(Write Unit Price)

ITEM NO. 51

GRAY CONCRETE SIDEWALK, 4" THICK

\$ 8,800.

80 S.Y. @ \$ 110.00 per Square Yard

one hundred ten dollars.
(Write Unit Price)

ITEM NO. 52

CONCRETE DRIVEWAY, REINFORCED, 6" TH.

\$ 600.00

6 S.Y. @ \$ 100.00 per Square Yard

ONE Hundred Dollars
(Write Unit Price)

ITEM NO. 53

CONCRETE DRIVEWAY, REINFORCED, 8" TH.

\$ 600.00

6 S.Y. @ \$ 100.00 per Square Yard

ONE Hundred Dollars
(Write Unit Price)

ITEM NO. 54

CAST IN PLACE DETECTABLE WARNING SURFACE

\$ 13,490.00

71 S.Y. @ \$ 190.00 per Square yard

ONE Hundred Ninety
(Write Unit Price)

ITEM NO. 55

9" X 20" CONCRETE VERTICAL CURB

\$ 91,169.60 ^{ATM}

3,040 L.F. @ \$ 29.99 per Linear Foot

TWENTY NINE DOLLARS NINETY NINE CENTS
(Write Unit Price)

ITEM NO. 56 9" X 20" GRAY CONCRETE VERTICAL CURB \$ 2,400.00
60 L.F. @ \$ 40.00 per Linear Foot
Sixty dollars
(Write Unit Price)

ITEM NO. 57 TRAFFIC MARKINGS, LINES, LONG LIFE \$ 16,445.65
THERMOPLASTIC, 4" WIDE
25,301 L.F. @ \$.65 per Linear Foot
SIXTY FIVE CENTS
(Write Unit Price)

ITEM NO. 58 TRAFFIC MARKINGS, SYMBOLS, LONG LIFE \$ 1,992.00
THERMOPLASTIC
332 S.F. @ \$ 6.00 per Square Foot
SIX DOLLARS
(Write Unit Price)

ITEM NO. 59 RESET WATER VALVE BOX \$ 990.00
(RAISE/LOWER ENTIRE BOX)
6 Units @ \$ 165.00 per Unit
One hundred sixty five
(Write Unit Price)

ITEM NO. 60 RESET WATER VALVE BOX \$ 1,750.00
(WITH RISER)
50 Units @ \$ 35.00 per Unit
THIRTY FIVE DOLLARS
(Write Unit Price)

ITEM NO. 61

NEW WATER VALVE BOX
(ENTIRE ASSEMBLY)

\$ 10,640.

38 Units @ \$ 280.⁷ per Unit

Three hundred eighty dollars
(Write Unit Price)

ITEM NO. 62

NEW WATER VALVE BOX
(UPPER ASSEMBLY)

\$ 2,470.

13 Units @ \$ 190.⁰⁰ per Unit

One hundred ninety dollars.
(Write Unit Price)

ITEM NO. 63

LOOP DETECTOR

\$ 49,250.

1,970 L.F. @ \$ 25.⁰⁰ per Linear Foot

Twenty five dollars
(Write Unit Price)

ITEM NO. 64

REGULATORY AND WARNING TRAFFIC SIGN
WITH STEEL U POST

\$ 18,975.

345 S.F. @ \$ 55.⁰⁰ per Square Foot

fifty five dollars
(Write Unit Price)

ITEM NO. 65

RELOCATE EXISTING TRAFFIC SIGN ON
NEW STEEL U POST

\$ 255.⁰⁰

1 Units @ \$ 255.⁰⁰ per Unit

two hundred fifty five dollars
(Write Unit Price)

ITEM NO. 66

RELOCATE OR REMOVE EXISTING
TRAFFIC SIGN

\$ 250.00

1 Units @ \$ 250.00 per Unit

Two hundred fifty dollars.
(Write Unit Price)

ITEM NO. 67

"NO PARKING" DRIVEWAY SYMOLS
MARKINGS

\$ 2,640.00

60 Units @ \$ 44.00 per Unit

FORTY FOUR DOLLARS
(Write Unit Price)

ITEM NO. 68

3" RIGID METALLIC CONDUIT, EARTH

\$ 2,500.00

100 L.F. @ \$ 25.00 per Linear Foot

Twenty five dollars
(Write Unit Price)

ITEM NO. 69

TRAFFIC SIGNAL CABLE, 5 CONDUCTOR

\$ 3,125.00

125 L.F. @ \$ 25.00 per Linear Foot

Twenty five dollars
(Write Unit Price)

ITEM NO. 70

VIDEO DETECTORS

\$ 24,000.00

8 Units @ \$ 3,000.00 per Unit

Three thousand dollars.
(Write Unit Price)

TOTAL BASE BID PRICE

\$ 1,225,901.29

(In figures)

\$ One million, two hundred twenty thousand,

(Price in Words, Dollars and Cents)

nine hundred one dollar and 29
cts.

ALTERNATE-A (WESTERVELT PL)
SCHEDULE OF PRICES

ITEM NO. 8	TEMPORARY TRAFFIC STRIPES, 4" WIDE 220 L.F. @ \$ <u>0.35</u> per Linear Feet <u>THIRTY FIVE CENTS</u> <hr/> (Write Unit Price)	\$ <u>77.00</u>
ITEM NO. 9	HMA PATCH 12 Tons @ \$ <u>100.00</u> per Ton <u>ONE HUNDRED DOLLARS</u> <hr/> (Write Unit Price)	\$ <u>1,200.00</u>
ITEM NO. 10	TRAFFIC DIRECTOR, FLAGGER. 5 Hours @ \$ <u>70.00</u> per Hour <u>seventy dollars.</u> <hr/> (Write Unit Price)	\$ <u>350.00</u>
ITEM NO. 11	TRAFFIC DIRECTOR, JERSEY CITY POLICE 60 Hours @ \$ <u>40.00</u> per Hour Forty Dollars and No Cents <hr/> (Write Unit Price)	\$ <u>2,400.00</u>
ITEM NO. 12	TRAFFIC DIRECTOR, JERSEY CITY POLICE (O.T.RATE, 7:00AM TO 4:00PM) 24 Hours @ \$ <u>57.50</u> per Hour Fifty Seven Dollars and Fifty Cents <hr/> (Write Unit Price)	\$ <u>1,380.00</u>

ITEM NO. 13	<p>TRAFFIC DIRECTOR, JERSEY CITY POLICE (O.T.RATE + NIGHT DIFFERENTIAL 4:00PM TO 6:00AM)</p> <p>24 Hour @ \$ <u>67.50</u> per Hour</p> <p>Sixty Seven Dollars and Fifty Cents</p> <hr/> (Write Unit Price)	\$ <u>1,620.00</u>
ITEM NO. 14	<p>TRAFFIC DIRECTOR, NIGHT TIME JC POLICE (NIGHT DIFFERENTIAL 4:00PM TO 6:00AM)</p> <p>6 Hour @ \$ <u>50.00</u> per Hour</p> <p>Fifty Dollars and No Cents</p> <hr/> (Write Unit Price)	\$ <u>300.00</u>
ITEM NO. 15	<p>TRAFFIC DIRECTOR, SUPERVISOR, JC POLICE</p> <p>21 Hours @ \$ <u>50.00</u> per Hour</p> <p>Fifty Dollars and No Cents</p> <hr/> (Write Unit Price)	\$ <u>1,050.00</u>
ITEM NO. 16	<p>TRAFFIC DIRECTOR, SUPERVISOR, JC POLICE (O.T. RATE AFTER 8 HOURS)</p> <p>16 Hour @ \$ <u>72.50</u> per Hour</p> <p>Seventy Two Dollars and Fifty Cents</p> <hr/> (Write Unit Price)	\$ <u>1,160.00</u>
ITEM NO. 17	<p>TRAFFIC DIRECTOR, SUPERVISOR, JC POLICE (O.T.RATE + NIGHT DIFFERENTIAL 4:00PM TO 6:00AM)</p> <p>8 Hour @ \$ <u>82.50</u> per Hour</p> <p>Eighty Two Dollars and Fifty Cents</p> <hr/> (Write Unit Price)	\$ <u>660.00</u>
ITEM NO. 18	<p>TRAFFIC DIRECTOR, NIGHT TIME SUPERVISOR (4:00PM TO 6:00AM) JERSEY CITY POLICE</p> <p>1 Hour @ \$ <u>60.00</u> per Hour</p> <p>Sixty Dollars and No Cents</p> <hr/> (Write Unit Price)	\$ <u>60.00</u>

ITEM NO. 19 POLICE VEHICLE AND FUEL. \$ 30.00

3 Hours @ \$ 10 per Hour

Ten Dollars and No Cents

(Write Unit Price)

ITEM NO. 22 H.M.A MILLING, 3" OR LESS

\$ 6,750.00

1,500 S.Y. @ \$ 4.50 per Square Yard

four dollars and fifty cents

(Write Unit Price)

ITEM NO. 23 HMA PAVEMENT REPAIR

\$ 1,920.00

24 Tons @ \$ 80.00 per Ton

eighty dollars

(Write Unit Price)

ITEM NO. 24 HMA, 19M64 BASE COURSE

\$ 480.00

4 Tons @ \$ 120.00 per Ton

ONE Hundred Twenty Dollars

(Write Unit Price)

ITEM NO. 25 HMA, 12.5M64 SURFACE COURSE

\$ 17,100.00

190 Tons @ \$ 90.00 per Ton

ninety dollars

(Write Unit Price)

ITEM NO. 26 HMA, 12.5H76 SURFACE COURSE

\$ 2,420.00

22 Tons @ \$ 110.00 per Ton

one hundred ten dollars

(Write Unit Price)

ITEM NO. 28 NEW CATCH BASIN, TYPE B \$ 2700.00

1 Units @ \$ 2700.00 per Unit

Twenty seven hundred dollars.
(Write Unit Price)

ITEM NO. 32 REPAIRED CATCH BASIN WALL \$ 1,200.00

4 S.F. @ \$ 300.00 per Square Foot

THREE Hundred DOLLARS
(Write Unit Price)

ITEM NO. 33 CATCH BASIN CASTING, TYPE B \$ 970.00

1 Units @ \$ 970.00 per Unit

nine hundred, seventy dollars.
(Write Unit Price)

ITEM NO. 36 CAST IRON CURB PIECE TYPE N, 6" HIGH \$ 600.00

2 Units @ \$ 300.00 per Unit

THREE Hundred DOLLARS
(Write Unit Price)

ITEM NO. 37 CAST IRON CURB PIECE TYPE N, 8" HIGH \$ 600.00

2 Units @ \$ 300.00 per Unit

THREE Hundred DOLLARS
(Write Unit Price)

ITEM NO. 38 BICYCLE SAFE GRATE, 21³/₄" x 47³/₄" \$ 600.00

2 Units @ \$ 300.00 per Unit

THREE Hundred DOLLARS
(Write Unit Price)

ITEM NO. 40 CATCH BASIN TRAP \$ 600.00

1 Units @ \$ 600.00 per Unit
Six hundred dollars
(Write Unit Price)

ITEM NO. 41 CATCH BASIN WALL PLATE \$ 600.

1 Units @ \$ 600.00 per Unit
Six hundred dollars
(Write Unit Price)

ITEM NO. 42 RESET EXISTING CASTINGS \$ 200.00

1 Units @ \$ 200.00 per Unit
two hundred dollars
(Write Unit Price)

ITEM NO. 45 MAHOLE CASTING, CATLOG NO:1007D \$ 2,750.00

5 Units @ \$ 550.00 per Unit
five hundred fifty dollars
(Write Unit Price)

ITEM NO. 47 DENSE GRADED AGGREGATE BACKFILL \$ 80.00

2 Tons @ \$ 40.00 per Ton
forty dollars
(Write Unit Price)

ITEM NO. 50 CONCRETE SIDEWALK, 4" THICK \$ 16,080.00

240 S.Y. @ \$ 67.00 per Square Yard
sixty seven dollars
(Write Unit Price)

ITEM NO. 40

CATCH BASIN TRAP

\$ 600.00

1 Units @ \$ 600.00 per Unit

Six hundred dollars
(Write Unit Price)

ITEM NO. 41

CATCH BASIN WALL PLATE

\$ 600.

1 Units @ \$ 600.00 per Unit

Six hundred dollars
(Write Unit Price)

ITEM NO. 42

RESET EXISTING CASTINGS

\$ 200.00

1 Units @ \$ 200.00 per Unit

two hundred Dollars
(Write Unit Price)

ITEM NO. 45

MAHOLE CASTING, CATLOG NO:1007D

\$ 2,750.00

5 Units @ \$ 550.00 per Unit

five hundred fifty dollars
(Write Unit Price)

ITEM NO. 47

DENSE GRADED AGGREGATE BACKFILL

\$ 80.00

2 Tons @ \$ 40.00 per Ton

forty dollars
(Write Unit Price)

ITEM NO. 50

CONCRETE SIDEWALK, 4" THICK

\$ 16,080.00

240 S.Y. @ \$ 67.00 per Square Yard

sixty seven dollars
(Write Unit Price)

ITEM NO. 54 CAST IN PLACE DETECTABLE WARNING SURFACE \$ 1,600.⁰⁰

8 S.Y. @ \$ 200.⁰⁰ per Square yard
Two Hundred Dollars
(Write Unit Price)

ITEM NO. 55 9" X 20" CONCRETE VERTICAL CURB \$ 9,000.⁰⁰

300 L.F. @ \$ 30.00 per Linear Foot
Thirty dollars
(Write Unit Price)

ITEM NO. 56 9" X 20" GRAY CONCRETE VERTICAL CURB \$ 450.⁰⁰

10 L.F. @ \$ 45.00 per Linear Foot
forty five dollars
(Write Unit Price)

ITEM NO. 57 TRAFFIC MARKINGS, LINES, LONG LIFE THERMOPLASTIC, 4" WIDE \$ 982.80

1,512 L.F. @ \$.65 per Linear Foot
SIXTY FIVE CENTS
(Write Unit Price)

ITEM NO. 58 TRAFFIC MARKINGS, SYMBOLS, LONG LIFE THERMOPLASTIC \$ 366.⁰⁰

61 S.F. @ \$ 6.00 per Square Foot
SIX DOLLARS
(Write Unit Price)

ITEM NO. 59 RESET WATER VALVE BOX (RAISE/LOWER ENTIRE BOX) \$ 100.⁰⁰

1 Units @ \$ 100.00 per Unit
one hundred dollars
(Write Unit Price)

ITEM NO. 60 RESET WATER VALVE BOX \$ 100.00
(WITH RISER)

1 Units @ \$ 100.00 per Unit

ONE HUNDRED DOLLARS
(Write Unit Price)

ITEM NO. 61 NEW WATER VALVE BOX \$ 1,120.00
(ENTIRE ASSEMBLY)

4 Units @ \$ 280.00 per Unit

Two hundred eighty dollars.
(Write Unit Price)

ITEM NO. 62 NEW WATER VALVE BOX \$ 380.00
(UPPER ASSEMBLY)

2 Units @ \$ 190.00 per Unit

One hundred ninety dollars.
(Write Unit Price)

ITEM NO. 64 REGULATORY AND WARNING TRAFFIC SIGN \$ 1,760.00
WITH STEEL U POST

32 S.F. @ \$ 55.00 per Square Foot

fifty five dollars
(Write Unit Price)

ITEM NO. 67 "NO PARKING" DRIVEWAY SYMOLS \$ 440.00
MARKINGS

10 Units @ \$ 44.00 per Unit

FOUR FOUR DOLLARS
(Write Unit Price)

TOTAL PRICE FOR ALTERNATE-A (WESTERVELT PL)

\$ 82,235.80

(In figures) \$ EIGHTY TWO THOUSAND TWO HUNDRED THIRTY FIVE
(Price in Words, Dollars and Cents) DOLLARS EIGHTY CENTS

ALTERNATE-B (HUTTON ST)

- ITEM NO. 8 TEMPORARY TRAFFIC STRIPES, 4" WIDE \$ 35.00
100 L.F. @ \$.35 per Linear Feet
THIRTY FIVE CENTS
(Write Unit Price)
- ITEM NO. 9 HMA PATCH \$ 1,200.00
12 Tons @ \$ 100.00 per Ton
ONE HUNDRED DOLLARS
(Write Unit Price)
- ITEM NO. 10 TRAFFIC DIRECTOR, FLAGGER. \$ 350.00
5 Hours @ \$ 70.00 per Hour
Seventy Dollars
(Write Unit Price)
- ITEM NO. 11 TRAFFIC DIRECTOR, JERSEY CITY POLICE \$ 3,200.00
80 Hours @ \$ 40.00 per Hour
Forty Dollars and No Cents
(Write Unit Price)
- ITEM NO. 12 TRAFFIC DIRECTOR, JERSEY CITY POLICE (\$ 460.00
O.T.RATE, 7:00AM TO 4:00PM)
8 Hours @ \$ 57.50 per Hour
Fifty Seven Dollars and Fifty Cents
(Write Unit Price)

ITEM NO. 13	<p>TRAFFIC DIRECTOR, JERSEY CITY POLICE (O.T.RATE + NIGHT DIFFERENTIAL 4:00PM TO 6:00AM)</p> <p>24 Hour @ \$ <u>67.50</u> per Hour</p> <p>Sixty Seven Dollars and Fifty Cents</p> <hr/> <p>(Write Unit Price)</p>	\$ <u>1,620.00</u>
ITEM NO. 14	<p>TRAFFIC DIRECTOR, NIGHT TIME JC POLICE (NIGHT DIFFERENTIAL 4:00PM TO 6:00AM)</p> <p>8 Hour @ \$ <u>50.00</u> per Hour</p> <p>Fifty Dollars and No Cents</p> <hr/> <p>(Write Unit Price)</p>	\$ <u>400.00</u>
ITEM NO. 15	<p>TRAFFIC DIRECTOR, SUPERVISOR, JC POLICE</p> <p>10 Hours @ \$ <u>50.00</u> per Hour</p> <p>Fifty Dollars and No Cents</p> <hr/> <p>(Write Unit Price)</p>	\$ <u>500.00</u>
ITEM NO. 16	<p>TRAFFIC DIRECTOR, SUPERVISOR, JC POLICE (O.T. RATE AFTER 8 HOURS)</p> <p>16 Hour @ \$ <u>72.50</u> per Hour</p> <p>Seventy Two Dollars and Fifty Cents</p> <hr/> <p>(Write Unit Price)</p>	\$ <u>1,160.00</u>
ITEM NO. 17	<p>TRAFFIC DIRECTOR, SUPERVISOR, JC POLICE (O.T.RATE + NIGHT DIFFERENTIAL 4:00PM TO 6:00AM)</p> <p>8 Hour @ \$ <u>82.50</u> per Hour</p> <p>Eighty Two Dollars and Fifty Cents</p> <hr/> <p>(Write Unit Price)</p>	\$ <u>660.00</u>
ITEM NO. 18	<p>TRAFFIC DIRECTOR, NIGHT TIME SUPERVISOR (4:00PM TO 6:00AM) JERSEY CITY POLICE</p> <p>1 Hour @ \$ <u>60.00</u> per Hour</p> <p>Sixty Dollars and No Cents</p> <hr/> <p>(Write Unit Price)</p>	\$ <u>60.00</u>

ITEM NO. 19 POLICE VEHICLE AND FUEL. \$ 20.00

2 Hours @ \$ 10 per Hour

Ten Dollars and No Cents

(Write Unit Price)

ITEM NO. 21 SAW CUTTING, 10" OR LESS \$ 400.00

400.L.F. @ \$ 1.00 per Linear Foot

ONE DOLLAR

(Write Unit Price)

ITEM NO. 22 H.M.A MILLING, 3" OR LESS \$ 8,000.00

2,000 S.Y. @ \$ 4.00 per Square Yard

four dollars.

(Write Unit Price)

ITEM NO. 23 HMA PAVEMENT REPAIR \$ 1,680.00

24 Tons @ \$ 70.00 per Ton

seventy dollars.

(Write Unit Price)

ITEM NO. 24 HMA, 19M64 BASE COURSE \$ 240.00

2 Tons @ \$ 120.00 per Ton

one hundred twenty dollars.

(Write Unit Price)

ITEM NO. 25 HMA, 12.5M64 SURFACE COURSE \$ 19,890.00

255 Tons @ \$ 78.00 per Ton

seventy eight dollars.

(Write Unit Price)

ITEM NO. 26 HMA, 12.5H76 SURFACE COURSE \$ 2,200.00
22 Tons @ \$ 100.00 per Ton
one hundred dollars
(Write Unit Price)

ITEM NO. 32 REPAIRED CATCH BASIN WALL \$ 400.00
4 S.F. @ \$ 100.00 per Square Foot
one hundred
(Write Unit Price)

ITEM NO. 33 CATCH BASIN CASTING, TYPE B \$ 2,600.00
1 Units @ \$ 2600.00 per Unit
twenty six hundred dollars
(Write Unit Price)

ITEM NO. 36 CAST IRON CURB PIECE TYPE N, 6" HIGH \$ 600.00
2 Units @ \$ 300.00 per Unit
THREE Hundred Dollars
(Write Unit Price)

ITEM NO. 37 CAST IRON CURB PIECE TYPE N, 8" HIGH \$ 600.00
2 Units @ \$ 300.00 per Unit
THREE Hundred Dollars
(Write Unit Price)

ITEM NO. 38 BICYCLE SAFE GRATE, 21 3/4" x 47 3/4" \$ 600.00
2 Units @ \$ 300.00 per Unit
THREE Hundred Dollars
(Write Unit Price)

ITEM NO. 40

CATCH BASIN TRAP

\$ 600.00

1 Units @ \$ 600.00 per Unit

Six hundred dollars.
(Write Unit Price)

ITEM NO. 41

CATCH BASIN WALL PLATE

\$ 600.00

1 Units @ \$ 600.00 per Unit

Six hundred dollars.
(Write Unit Price)

ITEM NO. 44

RELOCATE JUNCTION BOX

\$ 6,000.00

3 Units @ \$ 2000.00 per Unit

Two thousand dollars.
(Write Unit Price)

ITEM NO. 47

DENSE GRADED AGGREGATE BACKFILL

\$ 58.00

2 Tons @ \$ 29.00 per Ton

Twenty nine dollars.
(Write Unit Price)

ITEM NO. 50

CONCRETE SIDEWALK, 4" THICK

\$ 31,680.00

480 S.Y. @ \$ 66.00 per Square Yard

Sixty six dollars.
(Write Unit Price)

ITEM NO. 54

CAST IN PLACE DETECTABLE WARNING SURFACE

\$ 8,170.00

43 S.Y. @ \$ 190.00 per Square yard

ONE HUNDRED NINETY DOLLARS
(Write Unit Price)

ITEM NO. 55 9" X 20" CONCRETE VERTICAL CURB \$ 18,000.00
600 L.F. @ \$ 30.00 per Linear Foot
thirty dollars.
(Write Unit Price)

ITEM NO. 56 9" X 20" GRAY CONCRETE VERTICAL CURB \$ 450.00
10 L.F. @ \$ 45.00 per Linear Foot
forty five dollars.
(Write Unit Price)

ITEM NO. 57 TRAFFIC MARKINGS, LINES, LONG LIFE \$ 3,205.80
THERMOPLASTIC, 4" WIDE
4,932 L.F. @ \$.65 per Linear Foot
SIXTY FIVE CENTS
(Write Unit Price)

ITEM NO. 58 TRAFFIC MARKINGS, SYMBOLS, LONG LIFE \$ 168.00
THERMOPLASTIC
28 S.F. @ \$ 6.00 per Square Foot
SIX DOLLARS
(Write Unit Price)

ITEM NO. 59 RESET WATER VALVE BOX \$ 165.00
(RAISE/LOWER ENTIRE BOX)
1 Units @ \$ 165.00 per Unit
One hundred sixty five dollars.
(Write Unit Price)

ITEM NO. 60 RESET WATER VALVE BOX \$ 100.00
(WITH RISER)
1 Units @ \$ 100.00 per Unit
ONE HUNDRED DOLLARS
(Write Unit Price)

- ITEM NO. 62 NEW WATER VALVE BOX (UPPER ASSEMBLY) \$ 380.00
 2 Units @ \$ 190.00 per Unit
One hundred ninety dollars.
 (Write Unit Price)
- ITEM NO. 64 REGULATORY AND WARNING TRAFFIC SIGN WITH STEEL U POST \$ 3,740.00
 68 S.F. @ \$ 55.00 per Square Foot
fifty five dollars.
 (Write Unit Price)
- ITEM NO. 67 "NO PARKING" DRIVEWAY SYMOLS MARKINGS \$ 440.00
 10 Units @ \$ 44.00 per Unit
FORTY FOUR DOLLARS
 (Write Unit Price)
- ITEM NO. 68 3" RIGID METALLIC CONDUIT, EARTH \$ 2,500.00
 100 L.F. @ \$ 25.00 per Linear Foot
twenty five dollars.
 (Write Unit Price)
- ITEM NO. 69 TRAFFIC SIGNAL CABLE, 5 CONDUCTOR \$ 3,125.00
 125 L.F. @ \$ 25.00 per Linear Foot
twenty five dollars.
 (Write Unit Price)
- ITEM NO. 70 VIDEO DETECTORS \$ 3,000.00
 1 Units @ \$ 3000.00 per Unit
three thousand dollars.
 (Write Unit Price)

TOTAL PRICE FOR ALTERNATE-B (HUTTON ST)

\$ 129,256.80

(In figures)

\$ ONE Hundred Twenty Nine Thousand Two Hundred Fifty Six Dollars
(Price in Words, Dollars and Cents) Eighty CENTS

SUMMARY OF BID

TOTAL BASE BID PRICE

\$ 1,225,901.29

(In figures)

\$ ONE million Two hundred Twenty Five Thousand Nine hundred one
(Price in Words, Dollars and Cents) dollars twenty nine cen

TOTAL PRICE FOR BASE BID PLUS ALTERNATE-A

\$ 1,308,137.09

(In figures)

\$ One million, three hundred eight thousand, one
(Price in Words, Dollars and Cents) hundred thirty seven
dollars and ninety
cents

TOTAL PRICE FOR BASE BID PLUS ALTERNATE-A PLUS ALTERNATE-B

\$ 1,437,393.89

(In figures)

\$ One million, four hundred thirty seven thousand,
(Price in Words, Dollars and Cents) three hundred ninety three dollars and 89
cents

NOTE: If the base Bid is within the amount of funds available to finance the contract and the City wishes to accept Bids on the Alternate (s), then the Contract award will be made to that responsible Bidder submitting the lowest combined Bid, consisting of the Base Bid plus Alternate Bid (s). (applied in the alphabetical order in which they are listed in the Schedule of Prices). Under this procedure, if the City wishes to award on only the Base Bid, then the Contract will be awarded to that responsible Bidder submitting the lowest base Bid.



STATE OF NEW JERSEY BUSINESS REGISTRATION CERTIFICATE

Taxpayer Name: A J M CONTRACTORS, INC
Trade Name:
Address: 300 KULLER ROAD
CLIFTON, NJ 07011
Certificate Number: 0097438
Effective Date: March 06, 1981
Date of Issuance: June 09, 2011

For Office Use Only:
20110609103156566



New Jersey Division of Revenue

Revenue NJBGS

On-Line Business Registration Certificate Service

CERTIFICATE NUMBER 0097438 FOR A J M CONTRACTORS, INC. IS VALID.

ertificate Number
38866

Registration Date: 07/23/2012
Expiration Date: 07/22/2014

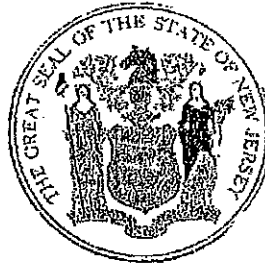

State of New Jersey

Department of Labor and Workforce Development
Division of Wage and Hour Compliance

Public Works Contractor Registration Act

Pursuant to N.J.S.A. 34:11-56.48, et seq. of the Public Works Contractor Registration Act, this certificate of registration is issued for purposes of bidding on any contract for public work or for engaging in the performance of any public work to:

AJM Contractors, Inc.
2012

Responsible Representative(s):
Anthony Marinaro, President

Harold J. Wirths

Harold J. Wirths, Commissioner
Department of Labor and Workforce Development

NON TRANSFERABLE

This certificate may not be transferred or assigned and may be revoked for cause by the Commissioner of Labor and Workforce Development.

EXHIBIT B (4 of 4)

(C) The contractor or subcontractor agrees that nothing contained in (B) above shall preclude the contractor or subcontractor from complying with the union hiring hall or apprenticeship policies in any applicable collective bargaining agreement or union hiring hall arrangement, and, where required by custom or agreement, it shall send journeymen and trainees to the union for referral, or to the apprenticeship program for admission, pursuant to such agreement or arrangement. However, where the practices of a union or apprenticeship program will result in the exclusion of minorities and women or the failure to refer minorities and women consistent with the targeted county employment goal, the contractor or subcontractor shall consider for employment persons referred pursuant to (B) above without regard to such agreement or arrangement; provided further, however, that the contractor or subcontractor shall not be required to employ women and minority advanced trainees and trainees in numbers which result in the employment of advanced trainees and trainees as a percentage of the total workforce for the construction trade, which percentage significantly exceeds the apprentice to journey worker ratio specified in the applicable collective bargaining agreement, or in the absence of a collective bargaining agreement, exceeds the ratio established by practice in the area for said construction trade. Also, the contractor or subcontractor agrees that, in implementing the procedures of (B) above, it shall, where applicable, employ minority and women workers residing within the geographical jurisdiction of the union.

After notification of award, but prior to signing a construction contract, the contractor shall submit to the public agency compliance officer and the Dept. of LWD, Construction EEO Monitoring Program an initial project workforce report (Form AA 201) electronically provided to the public agency by the Dept. of LWD, Construction EEO Monitoring Program, through its website, for distribution to and completion by the contractor, in accordance with N.J.A.C. 17:27-7. The contractor also agrees to submit a copy of the Monthly Project Workforce Report once a month thereafter for the duration of this contract to the Dept. of LWD, Construction EEO Monitoring Program and to the public agency compliance officer.

The contractor agrees to cooperate with the public agency in the payment of budgeted funds, as is necessary, for on the job and/or off the job programs for outreach and training of minorities and women.

(D) The contractor and its subcontractors shall furnish such reports or other documents to the Dept. of LWD, Construction EEO Monitoring Program as may be requested by the Dept. of LWD, Construction EEO Monitoring Program from time to time in order to carry out the purposes of these regulations, and public agencies shall furnish such information as may be requested by the Dept. of LWD, Construction EEO Monitoring Program for conducting a compliance investigation pursuant to Subchapter 10 of the Administrative Code (NJAC 17:27).

The undersigned vendor certifies on their company's receipt, knowledge and commitment to comply with:

EXHIBIT B

N.J.S.A. 10:5-31 et seq. (P.L. 1975, C. 127) and N.J.A.C. 17:27
MANDATORY EQUAL EMPLOYMENT OPPORTUNITY LANGUAGE
Construction Contracts

The undersigned vendor further agrees to furnish the required forms of evidence and understands that their contract/company's bid shall be rejected as non-responsive if said contractor fails to comply with the requirements of N.J.S.A. 10:5-31 et seq. (P.L. 1975, C. 127) and N.J.A.C. 17:27.

Representative's Name/Title (Print): Anthony J. Marinari, President
Representative's Signature: [Signature]
Name of Company: AJM Contractors Tel. No.: 973-772-9392 Date: 3-13-14

APPENDIX A
AMERICANS WITH DISABILITIES ACT OF 1990
Equal Opportunity for Individuals with Disability

The contractor and the President of AJM Contractors, Inc. (hereafter "owner") do hereby agree that the provisions of Title 11 of the Americans With Disabilities Act of 1990 (the "Act") (42 U.S.C. 5121 01 et seq.), which prohibits discrimination on the basis of disability by public entities in all services, programs, and activities provided or made available by public entities, and the rules and regulations promulgated pursuant there unto, are made a part of this contract. In providing any aid, benefit, or service on behalf of the owner pursuant to this contract, the contractor agrees that the performance shall be in strict compliance with the Act. In the event that the contractor, its agents, servants, employees, or subcontractors violate or are alleged to have violated the Act during the performance of this contract, the contractor shall defend the owner in any action or administrative proceeding commenced pursuant to this Act. The contractor shall indemnify, protect, and save harmless the owner, its agents, servants, and employees from and against any and all suits, claims, losses, demands, or damages, of whatever kind or nature, arising out of or claimed to arise out of the alleged violation. The contractor shall, at its own expense, appear, defend, and pay any and all charges for legal services and any and all costs and other expenses arising from such action or administrative proceeding or incurred in connection therewith. In any and all complaints brought pursuant to the owner's grievance procedure, the contractor agrees to abide by any decision of the owner which is rendered pursuant to said grievance procedure. If any action or administrative proceeding results in an award of damages against the owner, or if the owner incurs any expense to cure a violation of the ADA which has been brought pursuant to its grievance procedure, the contractor shall satisfy and discharge the same at its own expense.

The owner shall, as soon as practicable after a claim has been made against it, give written notice thereof to the contractor along with full and complete particulars of the claim. If any action or administrative proceeding is brought against the owner or any of its agents, servants, and employees, the owner shall expeditiously forward or have forwarded to the contractor every demand, complaint, notice, summons, pleading, or other process received by the owner or its representatives.

It is expressly agreed and understood that any approval by the owner of the services provided by the contractor pursuant to this contract will not relieve the contractor of the obligation to comply with the Act and to defend, indemnify, protect, and save harmless the owner pursuant to this paragraph.

It is further agreed and understood that the owner assumes no obligation to indemnify or save harmless the contractor, its agents, servants, employees and subcontractors for any claim which may arise out of their performance of this Agreement. Furthermore, the contractor expressly understands and agrees that the provisions of this indemnification clause shall in no way limit the contractor's obligations assumed in this Agreement, nor shall they be construed to relieve the contractor from any liability, nor preclude the owner from taking any other actions available to it under any other provisions of the Agreement or otherwise at law.

Representative's Name/Title Print: Anthony J. Macinani

Representative's Signature: [Signature]

Name of Company: AJM Contractors, Inc.

Tel. No.: 973-772-9292

Date: 3-13-14

Minority/Woman Business Enterprise (MWBE) Questionnaire for Bidders

Jersey City Ordinance C-829 establishes a goal of awarding 20% of the dollar amount of total city procurement to minority and woman owned business enterprises.

To assist us in monitoring our achievement of this goal, please indicate below whether your company is or is not a minority owned and/or woman owned business, and return this form with your bid proposal.

Business Name : A. Jm Contractors, Inc.
Address : 300 Kuller Road Edison, NJ 07011
Telephone No. : 973-772-9292
Contact Name: Analis Farr

Please check applicable category :

Minority Owned Business (MBE) Minority & Woman Owned Business (MWBE)
 Woman Owned business (WBE) Neither

Definitions:

Minority Business Enterprise

Minority Business Enterprise means a business which is a sole proprietorship, partnership or corporation at least 51% of which is owned and controlled by persons who are African American, Hispanic, Asian American, American Indian or Alaskan native, defined as follows:

- African American:** a person having origins in any of the black racial groups of Africa
- Hispanic:** a person of Mexican, Puerto Rican, Central or South American or other non-European Spanish culture or origin regardless of race.
- Asian:** a person having origins in any of the original peoples of the Far East, South East Asia, Indian subcontinent, Hawaii or the Pacific Islands.
- American Indian or Alaskan Native:** a person having origins in any of the original peoples of North America and who maintains cultural identification through tribal affiliation or community recognition.

Woman Business Enterprise

Woman Business Enterprise means a business which is a sole proprietorship, partnership or corporation at least 51% of which is owned and controlled by a woman or women.

OFFICE OF EQUAL EMPLOYMENT OPPORTUNITY/AFFIRMATIVE ACTION COPY

Form MWBE Contractor's Compliance Plan to be submitted with bid document.
CONTRACTOR: PROVIDE TWO (2) COMPLETED COPIES OF THIS FORM WITH YOUR PROPOSAL (or within 24 hours thereafter)

City of Jersey City
 Department of Administration
 Office of Equal Opportunity/Affirmative Action

Project: 2014 ROAD RESURFACING # E14-003
 Contractor: AJM Contractors, Inc Bid Amt. \$ 1,437,393.89

Please list what portions of the work, if any you intend to sublet, the approximate value of the same, and whether you anticipate subletting it to a minority or woman owned contractor, or neither.

Trade	Approx. \$ Value	Minority or Woman Owned Business Check appropriate column		
		Minority	Woman	Neither
ELECTRICAL	\$100,000			X
Concrete	\$180,000	X		
traffic marking	\$25,000.00			X

Receipt of this report by the City does not constitute acceptance by the City of minority business participation goals less than 20% or women business participation goals less than 20% unless specifically agreed to by the Office of Equal Opportunity/Affirmative Action

CONTINUED ON NEXT PAGE

OFFICE OF EQUAL EMPLOYMENT OPPORTUNITY/AFFIRMATIVE ACTION COPY

Form MWBE Contractor's Compliance Plan to be submitted with bid document.

CONTRACTOR: PROVIDE TWO (2) COMPLETED COPIES OF THIS FORM WITH YOUR PROPOSAL (or within 24 hours thereafter)

City of Jersey City
Department of Administration

Office of Equal Opportunity/Affirmative Action

Project:

Resurfacing of Various Streets, 2014 # *E14-003*

Contractor:

AJM Contractors, INC Bid Amt. \$ *1,437,393.89*

Please list what portions of the work, if any you intend to sublet, the approximate value of the same, and whether you anticipate subletting it to a minority or woman owned contractor, or neither.

Trade	Approx. \$ Value	Minority or Woman Owned Business Check appropriate column		
		Minority	Woman	Neither
<i>ELECTRICAL</i>	<i>\$100,000.00</i>			<i>X</i>
<i>CONCRETE</i>	<i>\$180,000.00</i>	<i>X</i>		
<i>TRAFFIC MARKING</i>	<i>\$25,000.00</i>			<i>X</i>

Receipt of this report by the City does not constitute acceptance by the City of minority business participation goals less than 20% or women business participation goals less than 20% unless specifically agreed to by the Office of Equal Opportunity/Affirmative Action

CONTINUED ON NEXT PAGE

DIVISION OF PURCHASING COPY

2. As to subcontracted trade mandated to be included in proposal pursuant to N.J.S.A. 40A:11-16, please list name of proposed subcontractor, trade, and whether minority woman, or not:

Trade	Contractor Name & Address	Approx \$ Value	Minority or Woman Owned Business Check appropriate column		
			Minority	Woman	Neither
ELECTRICAL	POSITIVE ELECTRIC 12 MYRTLE AVE BELLEVILLE, NJ	\$100,000			X
CONCRETE	BERTO 625 LEEVILLE AVE RAHWAY, NJ	\$180,000	X		
TRAFFIC MARKINGS	STATEWIDE STRIPING 499 Pomeroy Rd PARSIPPANY, NJ	\$25,000			X

3. What is your policy and practice with respect to outreach and consideration of minority and women-owned vendors/contractors as contractors and/or suppliers?

A pm reaches out to vendors/contractors that are minority women-owned and awards work to most qualified applicant.

Name of Contractor

By: Signature *[Signature]*

Type or print name/title: Anthony J. Marinaro

Telephone No: 93-772-9292 Date 3-13-14

For City Use:

Acceptable M/W Business Participation levels for this Project: _____

By _____ Date: _____

EQUAL EMPLOYMENT OPORTUNITY COPY

MWBE Page 3 Project 2014 ROAD RESURFACING PLAN

2. As to subcontracted trade mandated to be included in proposal pursuant to N.J.S.A. 40A:11-16, please list name of proposed subcontractor, trade, and whether minority woman, or not:

Trade	Contractor Name & Address	Approx. \$ Value	To Minority or Woman Owned Business Check appropriate column		
			Minority	Woman	Neither
ELECTRIC	Positive Electric 12 MYRTLE AVE BELLEVILLE, NJ	\$100,000			X
CONCRETE	BETTSVILLE AVE RAHWAY, NJ	\$180,000	X		
TRAFFIC MARKINGS	STATEWIDE SIGN. 740 PINEHURST RD. PATERSON, NJ	\$25,000			X

3. What is your policy and practice with respect to outreach and consideration of minority and women-owned vendors/contractors as contractors and/or suppliers?

A firm reaches out to vendors/contractors that are minority, women owned and award work to most qualified.

Name of Contractor A J M Contractors, Inc.

By: Signature [Signature]

Type or print name/title: Anthony J. Marinari President

Telephone No: 973-772-9292

Date: 3-13-14

For City Use:

Acceptable M/W Business Participation levels for this Project: _____

By _____

Date: _____

PURCHASING COPY

Resolution of the City of Jersey City, N.J.

City Clerk File No. Res. 14.497

Agenda No. 10.Z.4

Approved: JUL 16 2014

TITLE:



RESOLUTION AUTHORIZING THE AWARD OF CONTRACT TO J.A. ALEXANDER, INC. FOR BURMA ROAD AND PHILLIP STREET IMPROVEMENTS PROJECT NO. 11-020 FOR THE DEPARTMENT OF PUBLIC WORKS /DIVISION OF ARCHITECTURE, ENGINEERING AND TRAFFIC TRANSPORTATION

COUNCIL OFFERED AND MOVED ADOPTION OF THE FOLLOWING RESOLUTION:

WHEREAS, the City's Purchasing Director acting within his authority and in conformity with N.J.S.A. 40A:11-1 et. seq. has publicly advertised bids for **Burma Road and Phillip Street Improvements Project No. 11-020** for the Department of Public Works/Div. of Architecture, Engineering, Traffic and Transportation pursuant to specifications and bids thereof; and

WHEREAS, pursuant to public advertisement the City of Jersey City has received **Three (3) Bids**, the lowest responsible bid being that from **J.A. Alexander Inc**, 130-158 JFK Drive N, Bloomfield, NJ 07003, in the total bid amount of **One Million, Two Hundred Ninety Eight Thousand, Five Hundred Sixty One (\$1,298,561.00) Dollars**; and

WHEREAS, the City's Purchasing Director has certified that he considers said bid to be fair and reasonable; and

WHEREAS, the sum of **One Million, Two Hundred Ninety Eight Thousand, Five Hundred Sixty One (\$1,298,561.00) Dollars**, are available in the 2014 temporary and permanent budget; and

WHEREAS, the funds for this purchase are available in **State Grant - Base Acct #02-213-40-204-314** and **City Capital Police Acct #04-215-55-859-990**; and

Dept. of Public Works/Div. of Architecture, Engineering, Traffic & Transportation.

Acct. No.	P.O. #		Amount
02-213-40-204-314	114093	State Grant Base Acct	\$1,054,302.02
02-213-40-204-314	114094	State Grant Base Acct	\$128,177.86
02-213-40-204-314	114096	State Grant Base Acct Contingency	\$16,081.12
04-215-55-859-990	114095	City Capital Police Acct	\$100,000.00
		Total Contract Amt.	\$1,298,561.00

WHEREAS, these funds are available for this expenditure in accordance with requirements of the Local Budget Law, N.J.S.A. 40A:4-1 et. Seq.

WHEREAS, if funds are not available for the contract in the 2014 temporary and permanent budgets, the contract will be terminated.

NOW, THEREFORE, BE IT RESOLVED, by the Municipal Council of the City of Jersey City that the said bid of the aforementioned **J.A. Alexander Inc.** be accepted and that a contract be awarded to said company in the above amount, and the Director of Purchasing is directed to have such a contract drawn up and executed; and be it further

RESOLVED, that upon certification by an official or employee of the City authorized to receive the material pursuant to the contract, that the same has been received and that the requirements of the contract met, then; payment to the contractor shall be made in accordance with the provisions of the Local Fiscal Affairs Law, N.J.S.A. 40A:5-1 et. seq; and be it further

(Continued on page 2)

City Clerk File No. Res. 14.497

Agenda No. 10.Z.4 JUL 16 2014

TITLE: **RESOLUTION AUTHORIZING THE AWARD OF CONTRACT TO J.A. ALEXANDER, INC. FOR BURMA ROAD AND PHILLIP STREET IMPROVEMENTS PROJECT NO. 11-020 FOR THE DEPARTMENT OF PUBLIC WORKS /DIVISION OF ARCHITECTURE, ENGINEERING AND TRAFFIC TRANSPORTATION**

RESOLVED, this contract shall be subject to the condition that the vendor/contractor provide satisfactory evidence of compliance with the Affirmative Action Amendments to the Law Against Discrimination, N.J.S.A. 10:5-31 et. seq.; and be it further

RESOLVED, that the Mayor or Business Administrator is hereby authorized to execute a contract on behalf of the City of Jersey City.

I, Donna Mauer, Donna Mauer, Chief Financial Officer, certify that there are sufficient funds available for payment of this above resolution in account shown below.

Dept. of Public Works/Div. of Architecture, Engineering, Traffic & Transportation.

Acct. No.	P.O. #		Amount
02-213-40-204-314	114093	State Grant Base Acct	\$1,054,302.02
02-213-40-204-314	114094	State Grant Base Acct	\$128,177.86
02-213-40-204-314	114096	State Grant Base Acct Contingency	\$16,081.12
04-215-55-859-990	114095	City Capital Police Acct	\$100,000.00
Total Contract Amt.			\$1,298,561.00

Approved by Peter Folgado, RPPS
Peter Folgado, Director of Purchasing, QPA

APPROVED: _____

APPROVED AS TO LEGAL FORM

APPROVED: _____
Business Administrator

Corporation Counsel

Certification Required

Not Required

APPROVED 9-0

RECORD OF COUNCIL VOTE ON FINAL PASSAGE 7.16.14											
COUNCILPERSON	AYE	NAY	N.V.	COUNCILPERSON	AYE	NAY	N.V.	COUNCILPERSON	AYE	NAY	N.V.
GAJEWSKI	✓			YUN	✓			RIVERA	✓		
RAMCHAL	✓			OSBORNE	✓			WATTERMAN	✓		
BOGGIANO	✓			COLEMAN	✓			LAVARRO, PRES.	✓		

✓ Indicates Vote

N.V.-Not Voting (Abstain)

Adopted at a meeting of the Municipal Council of the City of Jersey City N.J.

Rolando R. Lavarro, Jr.
Rolando R. Lavarro, Jr., President of Council

Robert Byrne
Robert Byrne, City Clerk

RESOLUTION FACT SHEET - CONTRACT AWARD

This summary sheet is to be attached to the front of any resolution that is submitted for Council consideration. Incomplete or vague fact sheets will be returned with the resolution.

Full Title of Ordinance/Resolution

RESOLUTION AWARDDING CONTRACT TO J.A. ALEXANDER, INC. FOR THE BURMA ROAD AND PHILLIP STREET IMPROVEMENTS PROJECT NO. 11-020 FOR THE DEPARTMENT OF PUBLIC WORKS, DIVISION OF ARCHITECTURE & ENGINEERING

Project Manager

Department/Division	Dept. of Public Works	Architecture & Engineering
Name/Title	Stanley Huang P.E., Municipal Engineer	Director
Phone/email	201-547-4411	stanley@icnj.org

Note: Project Manager must be available by phone during agenda meeting (Wednesday prior to council meeting @ 4:00 p.m.)

There exists a need to mill and pave, replace guardrail, construct sidewalk and ADA curb ramps, install new signs, stripe, and perform associated work along Burma Rd. and Phillip St. between Bayview Circle and Audrey Zapp Drive as a result of the poor condition of the existing road.

Cost (Identify all sources and amounts)

Contract term (include all proposed renewals)

AMOUNT	
02-213-40-204-314 (State Grant -Base)	\$1,054,302.02
02-213-40-204-314 (State Grant- Alt. A)	\$128,177.86
02-213-40-204-314 (State Grant- Cont.)	\$16,081.12
04-215-55-859-990 (City Capital-Police)	\$100,000.00
TOTAL:	\$1,298,561.00

270 Calendar Days after issuance of Notice to Proceed

Type of award

If "Other Exception", enter type

Additional Information

The awarding resolution has been drafted by the Division of Purchasing. This was a public bid. There were three (3) bidders:
J.A. Alexander, Inc., Bloomfield NJ, Base Bid \$1,154,302.02; Alt A \$128,177.86; Total \$1,282,479.88
Black Rock Ent., LLC, Old Bridge, NJ, Base Bid \$1,344,959.13; Alt A \$119,191.75; Total \$1,464,150.88
Tilcon New York, Wharton, NJ, Base Bid \$1,384,612.65; Alt A \$144,387.35; Total \$1,529,000.00

I certify that all the facts presented herein are accurate.

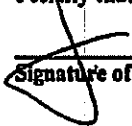
Signature of Department Director

7/3/14
Date



STEVEN M. FULOP
MAYOR OF JERSEY CITY

CITY OF JERSEY CITY
DEPARTMENT OF PUBLIC WORKS
 PUBLIC WORKS COMPLEX | 575 ROUTE 440 | JERSEY CITY, NJ 07305
 P: 201.547.4402 | F: 201.547.4803



MICHAEL E. RAZZOLI
DIRECTOR

MEMORANDUM

Date: July 3, 2014
To: Peter Folgado, Purchasing Director
From: Michael Razzoli, DPW Director
Subject: Recommendation Letter (Burma Road and Phillip Street)

Please be advised, after a careful and thorough review of bids received for Burma Road and Phillip Street Improvements Project, I recommend that the contract be awarded to:

J.A. ALEXANDER, INC
130-158 JFK DRIVE NORTH
BLOOMFIELD, NJ 07003

Total contract Amount = \$1,298,561.00

Please proceed and utilize the following requisitions listed below. Kindly draft the awarding resolution for the July 16th Council meeting.

REQ #	ACCOUNT NUMBER	AMOUNT
0165919	02-213-40-204-314 (State Grant)	\$1,054,302.02
0165922	02-213-40-204-314 (State Grant) - Alt. A	\$128,177.86
0165923	02-213-40-204-314 (State Grant) - Contingency	\$16,081.12
0165924	04-215-55-859-990 (Street Resurfacing Capital)	\$100,000.00
	TOTAL	\$1,298,561.00

Should you have any questions or need any additional justifications regarding this contract award, please do not hesitate to call my office at X 4400/01.

Michael Razzoli

C: Raquel Tosado, Contracts Manager
 James Madden, DPW Deputy Director
 Brian Weller, Director of Arch, Eng, & Traffic

Hector Ortiz, Deputy Director of Operations
Stanley Huang, Municipal Engineer
Bhavini Doshi, Confidential Aide, DPW Director's Office
Dawn Odom, Supvr. Adm. Analyst
Zakia Gregory, DPW Fiscal Office
Paola Campbell, Purchasing Division



STEVEN M. FULOP
MAYOR OF JERSEY CITY

**CITY OF JERSEY CITY
DEPARTMENT OF PUBLIC WORKS**

PUBLIC WORKS COMPLEX | 575 ROUTE 440 | JERSEY CITY, NJ 07305
P: 201 547 4402 | F: 201 547 4803



MICHAEL E. RAZZOLI
DIRECTOR

MEMORANDUM

Date: July 2, 2014
To: Michael E. Razzoli, Director, Department of Public Works
From: Brian F. Weller, LLA, ASLA, Director, Div. of Arch. & Eng. *BFW*
Subject: Award Recommendation
 Burma Road & Phillip Street Improvements
 Project No. 11-020

=====

Please be advised, after careful and thorough review of the bids received for the above-referenced project, I recommend that the contract be awarded to: **J.A. Alexander, Inc., 130-158 John F. Kennedy Drive North, Bloomfield N.J. 07003** in the total bid amount of **\$1,282,479.88** consisting of \$1,154,302.02 for the base bid plus \$128,177.86 for Alternate A.

The requisitions for this project are listed below. resolution to be presented at the July 16th, 2014 Council Meeting.

REQ. #	ACCOUNT #	AMOUNT
0165919	02-213-40-204-314 (State Grant -Base)	\$1,054,302.02
0165922	02-213-40-204-314 (State Grant- Alt. A)	\$128,177.86
0165923	02-213-40-204-314 (State Grant- Cont.)	\$16,081.12
0165924	04-215-55-859-990 (City Capital-Police)	\$100,000.00
	TOTAL:	\$1,298,561.00

Should you have any questions or need any additional justifications, please do not hesitate to contact this office.

cc: James Madden, DPW Deputy Director
 Bhavini Doshi, Esq., Confidential Aide, DPW Director's Office
 Stanley Huang, P.E. Municipal Engineer
 Dawn Odom, Supervising Admin. Analyst
 Chris Piersa P.E., Principal Engineer

SCHEDULE OF PRICES

ITEM NO. 1 CELLULAR PHONE SERVICE ALLOWANCE
Lump Sum \$ 1,500.00

one thousand, five hundred
(Write Lump Sum Price) dollars.

ITEM NO. 2 CONSTRUCTION LAYOUT
Lump Sum \$ 5,000.00

Five thousand dollars.
(Write Lump Sum Price)

ITEM NO. 3 BREAKAWAY BARRICADE
4 Units @ \$ 0.01 per Unit \$ 0.04

One cent
(Write Unit Price)

ITEM NO. 4 DRUM
50 Units @ \$ 0.01 per Unit \$ 0.50

One cent
(Write Unit Price)

ITEM NO. 5 TRAFFIC CONE
100 Units @ \$ 0.01 per Unit \$ 1.00

one cent
(Write Unit Price)

SCHEDULE OF PRICES

ITEM NO. 6 CONSTRUCTION SIGNS

200 S.F. @ \$ 0.01 per Square Foot \$ 2.00

One cent
(Write Unit Price)

ITEM NO. 7 FUEL PRICE ADJUSTMENT

2,900 Dollars @ \$ 1.00 \$ 2,900.00

One Dollar and No Cents

ITEM NO. 8 ASPHALT PRICE ADJUSTMENT

12,200 Dollars @ \$ 1.00 \$ 12,200.00

One Dollar and No Cents

ITEM NO. 9 CLEARING SITE

Lump Sum \$ 300,000.00

Three hundred thousand
(Write Lump Sum Price)

ITEM NO. 10 EXCAVATION, TEST PIT

10 CY @ \$ 0.01 per Cubic Yard \$ 0.10

One cent
(Write Unit Price)

SCHEDULE OF PRICES

- ITEM NO. 11 EXCAVATION, UNCLASSIFIED
3,550 CY @ \$ 0.01 per Cubic Yard \$ 35.50
one cent
(Write Unit Price)
- ITEM NO. 12 DENSE GRADED AGGREGATE BASE COURSE, 8"
THICK
4,235 SY @ \$ 0.01 per Square Yard \$ 42.35
one cent
(Write Unit Price)
- ITEM NO. 13 HMA MILLING, 3" OR LESS
13,875 SY @ \$ 4.00 per Square Yard \$ 55,500.00
Four Dollars
(Write Unit Price)
- ITEM NO. 14 HMA MILLING, MORE THAN 3" TO 6"
4,115 SY @ \$ 6.00 per Square Yard \$ 24,690.00
Six Dollars
(Write Unit Price)
- ITEM NO. 15 POLYMERIZED JOINT ADHESIVE
9,250 LF @ \$ 0.01 per Linear Foot \$ 92.50
one cent
(Write Unit Price)

SCHEDULE OF PRICES

ITEM NO. 16

TACK COAT

1,820 Gal @ \$ 0.01 per Gallon \$ 18.20

One cent
(Write Unit Price)

ITEM NO. 17

HOT MIX ASPHALT, 12.5M76, SURFACE COURSE,
2" THICK

2,490 Tons @ \$ ^{83.00} ~~65.00~~ per Ton 206,670.00

Eighty three
Sixty five dollars
(Write Unit Price)

ITEM NO. 18

HOT MIX ASPHALT, 19M64, BASE COURSE,
3" THICK

540 Tons @ \$ ^{65.00} ~~65.00~~ per Ton 35,100.00

Sixty five dollars
(Write Unit Price)

ITEM NO. 19

HOT MIX ASPHALT, 19M64, BASE COURSE,
8" THICK

2,660 Tons @ \$ ^{65.00} ~~65.00~~ per Ton \$ 172,900.00

Sixty five dollars
(Write Unit Price)

ITEM NO. 20

12" DUCTILE IRON PIPE, CLASS 52

144 LF @ \$ 150.00 per Linear Foot \$ 21,600.00

One hundred and fifty dollars
(Write Unit Price)

SCHEDULE OF PRICES

ITEM NO. 21	INLET, TYPE 'B'		
	4 Units @ \$3,000.00 per Unit		<u>\$12,000.00</u>
	<u>Three thousand dollars</u> (Write Unit Price)		
ITEM NO. 22	DRAINAGE MANHOLE, 5' DIAMETER (J.C. TYPE 'B')		
	1 Units @ \$3,500.00 per Unit		<u>\$3,500.00</u>
	<u>Three thousand and five</u> (Write Unit Price) <u>hundred dollars.</u>		
ITEM NO. 23	SET INLET CASTING, TYPE 'B'		
	3 Units @ \$1,000.00 per Unit		<u>\$3,000.00</u>
	<u>one thousand dollars</u> (Write Unit Price)		
ITEM NO. 24	SET INLET CASTING, TYPE 'E'		
	1 Unit @ \$1,200.00 per Unit		<u>\$1,200.00</u>
	<u>one thousand two hundred</u> (Write Unit Price) <u>dollars</u>		
ITEM NO. 25	RESET MANHOLE CASTING, USING CASTING NO. 1007D		
	10 Units @ \$220.00 per Unit		<u>\$2,200.00</u>
	<u>two hundred and twenty</u> (Write Unit Price)		

SCHEDULE OF PRICES

ITEM NO. 26 SET MANHOLE CASTING, USING CASTING NO. 1007D

2 Units @ \$ 500.00 per Unit \$ 1,000.00

Five hundred dollars
(Write Unit Price)

ITEM NO. 27 CATCH BASIN WALL PLATE

4 Units @ \$ 500.00 per Unit \$ 2,000.00

Five hundred dollars
(Write Unit Price)

ITEM NO. 28 CATCH BASIN TRAP

4 Units @ \$ 550.00 per Unit \$ 2,200.00

Five hundred and fifty
(Write Unit Price) Dollars

ITEM NO. 29 INLET FILTER, TYPE 1

7 Units @ \$ 0.07 per Unit \$ 0.07

One cent
(Write Unit Price)

ITEM NO. 30 INLET FILTER, TYPE 2

1 Units @ \$ 0.01 per Unit \$ 0.01

One cent
(Write Unit Price)

SCHEDULE OF PRICES

ITEM NO. 31 CONCRETE SIDEWALK, 4" THICK

20 SY @ \$125.00 per Square Yard \$ 2,500.00

One hundred and twenty five
(Write Unit Price) Dollars.

ITEM NO. 32 DETECTABLE WARNING SURFACE, CAST IN PLACE

2 SY @ \$350.00 per Square Yard \$ 700.00

Three hundred and fifty
(Write Unit Price) Dollars.

ITEM NO. 33 9" X 20" CONCRETE VERTICAL CURB

150 L.F. @ \$100.00 per Linear Foot \$ 15,000.00

One hundred Dollars
(Write Unit Price)

ITEM NO. 34 BEAM GUIDE RAIL

6,400 L.F. @ \$17.20 per Linear Foot \$ 110,080.00

Seventeen Dollars and twenty
(Write Unit Price) Cents.

ITEM NO. 35 FLARED GUIDE RAIL TERMINAL

11 Units @ \$2,100.00 per Unit \$ 23,100.00

Two thousand, one hundred
(Write Unit Price) Dollars.

SCHEDULE OF PRICES

ITEM NO. 36 REMOVAL OF BEAM GUIDE RAIL

6,795 L.F. @ \$ 0.625 per Linear Foot \$ 4,416.75

Sixty Five CENTS
(Write Unit Price)

ITEM NO. 37 TRAFFIC STRIPES, LONG LIFE, THERMOPLASTIC,
4" WIDE

12,840 LF @ \$ 0.60 per Linear Foot \$ 7,704.00

Sixty CENTS
(Write Unit Price)

ITEM NO. 38 TRAFFIC MARKINGS, SYMBOLS, LONG-LIFE,
THERMOPLASTIC

640 SF @ \$ 6.10 per Square Foot \$ 3,904.00

Six Dollars and Ten cents
(Write Unit Price)

ITEM NO. 39 REGULATORY AND WARNING SIGNS WITH
STEEL U-POST

40 SF @ \$ 40.00 per Square Foot \$ 1,600.00

Forty Dollars
(Write Unit Price)

ITEM NO. 40 RAISE OR LOWER ENTIRE WATER VALVE BOX

4 Units @ \$ 25.00 per Unit \$ 100.00

Twenty Five Dollars
(Write Unit Price)

SCHEDULE OF PRICES

ITEM NO. 41 RESET WATER VALVE BOX WITH RISER

20-2-23

1 Units @ \$ 25.00 per Unit \$ 25.00

Twenty five dollars
(Write Unit Price)

ITEM NO. 42 NEW WATER VALVE BOX (ENTIRE ASSEMBLY)

20-2-23

1 Units @ \$ 300.00 per Unit \$ 300.00

Three hundred dollars
(Write Unit Price)

20-2-23

ITEM NO. 43 LOOP DETECTOR

300 LF @ \$ 38.00 per Linear Foot \$ 11,400.00

Thirty eight dollars
(Write Unit Price)

ITEM NO. 44 BORROW TOPSOILING, 4" THICK

535 CY @ \$ 5.00 per Cubic Yard \$ 2,675.00

Five dollars
(Write Unit Price)

20-2-23



20-2-23
20-2-23
20-2-23

SCHEDULE OF PRICES

ITEM NO. 45 SEEDING AND FERTILIZING, TYPE G
4,950 SY @ \$0.55 per Square Yard \$ 2,722.50
Fifty Five CENTS
(Write Unit Price)

ITEM NO. 46 STRAW MULCHING
4,950 SY @ \$0.55 per Square Yard \$ 2,722.50
Fifty Five CENTS
(Write Unit Price)

SUBTOTAL (ITEMS 1-46) \$ 1,054,302.02

ITEM NO. 47 TRAFFIC DIRECTOR, JERSEY CITY POLICE
Lump Sum \$ 100,000.00
One Hundred Thousand Dollars and No Cents
(Write Unit Price)

TOTAL BASE BID PRICE
\$ 1,154,302.02
(In Figures)

\$ one million, one hundred and fifty Four thousand,
(Price In Words - Dollars and Cents) three hundred and two
Dollars and two CENTS.

SCHEDULE OF PRICES
ALTERNATE A

Add the following Items:

ITEM NO. 10A EXCAVATION, TEST PIT

2 CY @ \$ 0.01 per Cubic Yard

\$ 0.02

One Cent
(Write Unit Price)

ITEM NO. 11A EXCAVATION, UNCLASSIFIED

485 CY @ \$ 0.01 per Cubic Yard

\$ 4.85

One Cent
(Write Unit Price)

**ITEM NO. 12A DENSE GRADED AGGREGATE
BASE COURSE, 8" THICK**

480 SY @ \$ 0.01 per Square Yard

\$ 4.80

One Cent
(Write Unit Price)

ITEM NO. 13A HMA MILLING, 3" OR LESS

2,840 SY @ \$ 7.50 per Square Yard \$ 21,300.00

Seven Dollars and fifty cents.
(Write Unit Price)

ITEM NO. 15A POLYMERIZED JOINT ADHESIVE

2,000 LF @ \$ 0.01 per Linear Foot

\$ 20.00

One Cent
(Write Unit Price)

SCHEDULE OF PRICES
ALTERNATE A

ITEM NO. 16A TACK COAT

315 Gal @ \$ 0.01 per Gallon \$ 3.15

One Cent
(Write Unit Price)

ITEM NO. 17A HOT MIX ASPHALT, 12.5M76,
SURFACE COURSE, 2" THICK

415 Tons @ \$ 93.00 per Ton \$ 38,595.00

ninety three Dollars
(Write Unit Price)

ITEM NO. 19A HOT MIX ASPHALT, 19M64,
BASE COURSE, 8" THICK

230 Tons @ \$ 185.00 per Ton \$ 42,550.00

One hundred and Eighty Five Dollars
(Write Unit Price)

ITEM NO. 20A 12" DUCTILE IRON PIPE, CLASS 52

50 LF @ \$ 150.00 per Linear Foot \$ 7,500.00

One hundred and fifty Dollars.
(Write Unit Price)

ITEM NO. 21A INLET, TYPE 'B'

1 Unit @ \$ 3,000.00 per Unit \$ 3,000.00

three thousand Dollars.
(Write Unit Price)

SCHEDULE OF PRICES
ALTERNATE A

ITEM NO. 27A CATCH BASIN WALL PLATE
2 Units @ \$ 550.00 per Unit \$ 1,100.00

Five hundred and fifty
(Write Unit Price) dollars

ITEM NO. 28A CATCH BASIN TRAP
2 Units @ \$ 550.00 per Unit \$ 1,100.00

Five hundred and fifty
(Write Unit Price) dollars

ITEM NO. 29A INLET FILTER, TYPE 1
2 Units @ \$ 0.01 per Unit \$ 0.02

One cent
(Write Unit Price)

ITEM NO. 30A INLET FILTER, TYPE 2
2 Units @ \$ 0.01 per Unit \$ 0.02

one cent
(Write Unit Price)

ITEM NO. 33A 9" X 20" CONCRETE VERTICAL CURB
80 L.F. @ \$ 100.00 per Linear Foot \$ 8,000.00

one hundred dollars
(Write Unit Price)

SCHEDULE OF PRICES
ALTERNATE A

ITEM NO. 48A DRAINAGE DOGHOUSE
MANHOLE, 5' DIAMETER (JERSEY CITY TYPE 'B')

1 Unit @ \$5,000.00 per Unit \$ 5,000.00

Five thousand Dollars.
(Write Unit Price)

TOTAL PRICE FOR ALTERNATE A:

\$ 128,177.86
(Price in Figures)

one hundred and twenty eight thousand, one
(Price in Words, Dollars and Cents)
hundred and seventy seven dollars and eighty six cents.

SUMMARY OF BIDS

TOTAL BASE BID PRICE:

\$ 1,154,302.02
(Price in Figures)

One Million, one hundred and fifty four thousand,
(Price in Words, Dollars and Cents) three hundred and two
Dollars and two cents.

TOTAL BID PRICE FOR ALTERNATE A:

\$ 1,282,479.88
(Price in Figures)

One Million, two hundred and Eighty two thousand, four
(Price in Words, Dollars and Cents) hundred and seventy nine
Dollars and Eighty Eight cents

TOTAL PRICE FOR BASE BID PLUS ALTERNATE A:

\$ 1,282,479.88
(Price in Figures)

One Million, two hundred and Eighty two thousand, four
(Price in Words, Dollars and Cents) hundred and seventy nine
Dollars and Eighty Eight
Cents.

*NOTE: If the Base Bid is within the amount of funds available to finance the Contract, and the City wishes to accept Bids of the Alternate (s), then the Contract award will be made to that responsible Bidder submitting the lowest combined Bid, consisting of the Base Bid plus Alternate Bid (s) (applied in the alphabetical order in which they are listed in the Schedule of Prices). Under this procedure, if the City wishes to award on only the Base Bid, then the Contract will be awarded to that responsible Bidder submitting the lowest Base Bid.

STATE OF NEW JERSEY
BUSINESS REGISTRATION CERTIFICATE
FOR STATE AGENCY AND CASINO SERVICE CONTRACTORS

DEPARTMENT OF TREASURY
DIVISION OF REVENUE
PO BOX 222
TRENTON, NJ 08646-0252

TAXPAYER NAME:

J. A. ALEXANDER, INC.

TRADE NAME:

TAXPAYER IDENTIFICATION#:

SEQUENCE NUMBER:

0068626

ADDRESS:

130 JFK DRIVE NORTH
BLOOMFIELD, NJ 07003

ISSUANCE DATE:

07/23/04

EFFECTIVE DATE:

01/04/79

FORM-BRC(08-01)

Acting Director

This Certificate is NOT assignable or transferable. It must be conspicuously displayed at above address.



New Jersey Division of Revenue

Revenue NJBGS

On-Line Business Registration Certificate Service

CERTIFICATE NUMBER 0068626 FOR J. A. ALEXANDER, INC. IS VALID.

Certificate Number:
68617

Registration Date: 04/11/2014
Expiration Date: 04/10/2016



State of New Jersey

Department of Labor and Workforce Development Division of Wage and Hour Compliance

Public Works Contractor Registration Act

Pursuant to N.J.S.A. 34:11-56.48, et seq. of the Public Works Contractor Registration Act, this certificate of registration is issued for purposes of bidding on any contract for public work or for engaging in the performance of any public work to:

J.A. Alexander, Inc.
2014

Responsible Representative(s):

Jose D Rebimbas, President

Handwritten signature of Harold J. Wirths.

Harold J. Wirths, Commissioner
Department of Labor and Workforce Development

NON TRANSFERABLE

This certificate may not be transferred or assigned and may be revoked for cause by the Commissioner of Labor and Workforce Development.

Certification 23505

CERTIFICATE OF EMPLOYEE INFORMATION REPORT RENEWAL

This is to certify that the contractor listed below has submitted an Employee Information Report pursuant to N.J.A.C. 17:27-1.1 et. seq. and the State Treasurer has approved said report. This approval will remain in effect for the period of 15 - AUG - 2017 TO 15 - AUG - 2018

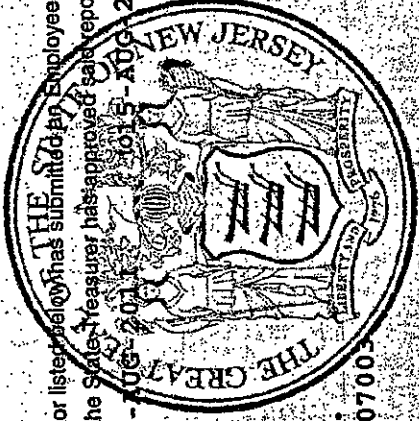

J.A. ALEXANDER, INC.
130 JOHN F. KENNEDY DR.
N. BLOOMFIELD NJ 07003



A handwritten signature in black ink, appearing to read "Andrew P. Sidamon-Einstoff".

Andrew P. Sidamon-Einstoff
State Treasurer

EXHIBIT B (4 of 4)

(C) The contractor or subcontractor agrees that nothing contained in (B) above shall preclude the contractor or subcontractor from complying with the union hiring hall or apprenticeship policies in any applicable collective bargaining agreement or union hiring hall arrangement, and, where required by custom or agreement, it shall send journeymen and trainees to the union for referral, or to the apprenticeship program for admission, pursuant to such agreement or arrangement. However, where the practices of a union or apprenticeship program will result in the exclusion of minorities and women or the failure to refer minorities and women consistent with the targeted county employment goal, the contractor or subcontractor shall consider for employment persons referred pursuant to (B) above without regard to such agreement or arrangement; provided further, however, that the contractor or subcontractor shall not be required to employ women and minority advanced trainees and trainees in numbers which result in the employment of advanced trainees and trainees as a percentage of the total workforce for the construction trade, which percentage significantly exceeds the apprentice to journey worker ratio specified in the applicable collective bargaining agreement, or in the absence of a collective bargaining agreement, exceeds the ratio established by practice in the area for said construction trade. Also, the contractor or subcontractor agrees that, in implementing the procedures of (B) above, it shall, where applicable, employ minority and women workers residing within the geographical jurisdiction of the union.

After notification of award, but prior to signing a construction contract, the contractor shall submit to the public agency compliance officer and the Dept. of LWD, Construction EEO Monitoring Program an initial project workforce report (Form AA 201) electronically provided to the public agency by the Dept. of LWD, Construction EEO Monitoring Program, through its website, for distribution to and completion by the contractor, in accordance with N.J.A.C. 17:27-7. The contractor also agrees to submit a copy of the Monthly Project Workforce Report once a month thereafter for the duration of this contract to the Dept. of LWD, Construction EEO Monitoring Program and to the public agency compliance officer.

The contractor agrees to cooperate with the public agency in the payment of budgeted funds, as is necessary, for on the job and/or off the job programs for outreach and training of minorities and women.

(D) The contractor and its subcontractors shall furnish such reports or other documents to the Dept. of LWD, Construction EEO Monitoring Program as may be requested by the Dept. of LWD, Construction EEO Monitoring Program from time to time in order to carry out the purposes of these regulations, and public agencies shall furnish such information as may be requested by the Dept. of LWD, Construction EEO Monitoring Program for conducting a compliance investigation pursuant to Subchapter 10 of the Administrative Code (NJAC 17:27).

The undersigned vendor certifies on their company's receipt, knowledge and commitment to comply with:

EXHIBIT B

**N.J.S.A. 10:5-31 et seq. (P.L. 1975, C. 127) and N.J.A.C. 17:27
MANDATORY EQUAL EMPLOYMENT OPPORTUNITY LANGUAGE
Construction Contracts**

The undersigned vendor further agrees to furnish the required forms of evidence and understands that their contract/company's bid shall be rejected as non-responsive if said contractor fails to comply with the requirements of N.J.S.A. 10:5-31 et seq. (P.L. 1975, C. 127) and N.J.A.C. 17:27.

Representative's Name/Title (Print): Joseph D. Debirebas, President

Representative's Signature: [Signature]

Name of Company: J.A. Alexander Inc. Tel. No.: 973-680-0220 Date: 6-12-14

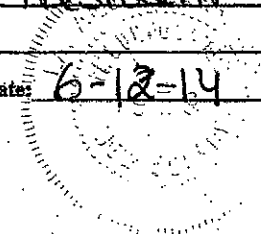

APPENDIX A
AMERICANS WITH DISABILITIES ACT OF 1990
Equal Opportunity for Individuals with Disability

The contractor and the City of Jersey City (hereafter "owner") do hereby agree that the provisions of Title 11 of the Americans With Disabilities Act of 1990 (the "Act") (42 U.S.C. 5121 01 et seq.), which prohibits discrimination on the basis of disability by public entities in all services, programs, and activities provided or made available by public entities, and the rules and regulations promulgated pursuant there unto, are made a part of this contract. In providing any aid, benefit, or service on behalf of the owner pursuant to this contract, the contractor agrees that the performance shall be in strict compliance with the Act. In the event that the contractor, its agents, servants, employees, or subcontractors violate or are alleged to have violated the Act during the performance of this contract, the contractor shall defend the owner in any action or administrative proceeding commenced pursuant to this Act. The contractor shall indemnify, protect, and save harmless the owner, its agents, servants, and employees from and against any and all suits, claims, losses, demands, or damages, of whatever kind or nature arising out of or claimed to arise out of the alleged violation. The contractor shall, at its own expense, appear, defend, and pay any and all charges for legal services and any and all costs and other expenses arising from such action or administrative proceeding or incurred in connection therewith. In any and all complaints brought pursuant to the owner's grievance procedure, the contractor agrees to abide by any decision of the owner which is rendered pursuant to said grievance procedure. If any action or administrative proceeding results in an award of damages against the owner, or if the owner incurs any expense to cure a violation of the ADA which has been brought pursuant to its grievance procedure, the contractor shall satisfy and discharge the same at its own expense.

The owner shall, as soon as practicable after a claim has been made against it, give written notice thereof to the contractor along with full and complete particulars of the claim. If any action or administrative proceeding is brought against the owner or any of its agents, servants, and employees, the owner shall expeditiously forward or have forwarded to the contractor every demand, complaint, notice, summons, pleading, or other process received by the owner or its representatives.

It is expressly agreed and understood that any approval by the owner of the services provided by the contractor pursuant to this contract will not relieve the contractor of the obligation to comply with the Act and to defend, indemnify, protect, and save harmless the owner pursuant to this paragraph.

It is further agreed and understood that the owner assumes no obligation to indemnify or save harmless the contractor, its agents, servants, employees and subcontractors for any claim which may arise out of their performance of this Agreement. Furthermore, the contractor expressly understands and agrees that the provisions of this indemnification clause shall in no way limit the contractor's obligations assumed in this Agreement, nor shall they be construed to relieve the contractor from any liability, nor preclude the owner from taking any other actions available to it under any other provisions of the Agreement or otherwise at law.

Representative's Name/Title Print: Joseph M. Richards
Representative's Signature: _____
Name of Company: J. A. Alexander Inc.
Tel. No.: 973-680-0220 Date: 6-12-14

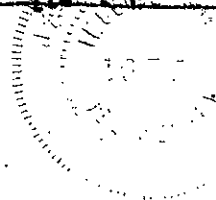

SAMPLE LETTER TO THE UNION

(CONTRACTOR'S LETTER HEAD)

Date:

Local Union: _____

Re: _____ Project, Jersey City, NJ

This company is about to enter into a contract with the City of Jersey City for the above project. A condition of the contract is compliance with the state approved affirmative action program, which requires that we make a good faith effort to use minority workers in each construction trade to the extent of ____% of the total work hours, and female workers to the extent of 6.9% of total work hours.

We are further required to submit a statement from an authorized union official, that the union will take such actions as may be necessary with respect to the referral and employment of minority group persons in order to enable this contractor to meet its obligations under the affirmative action plan.

We solicit your help and cooperation, by engaging in aggressive recruitment of minority workers, providing us with the statement requested, and advising whether the union will be able to fulfill our work force needs as indicated.

Very Truly Yours,



Minority/Woman Business Enterprise (MWBE) Questionnaire for Bidders

Jersey City Ordinance C-829 establishes a goal of awarding 20% of the dollar amount of total city procurement to minority and woman owned business enterprises.

To assist us in monitoring our achievement of this goal, please indicate below whether your company is or is not a minority owned and/or woman owned business, and return this form with your bid proposal.

Business Name : J.A. Alexander Inc.
Address : 130 John F. Kennedy Dr. No. Bloomfield, NJ 07003
Telephone No. : 973-680-0220
Contact Name: Jose D. Rehimbas

Please check applicable category :

Minority Owned Business (MBE) Minority & Woman Owned Business (MWBE)
 Woman Owned business (WBE) Neither

Definitions:

Minority Business Enterprise

Minority Business Enterprise means a business which is a sole proprietorship, partnership or corporation at least 51% of which is owned and controlled by persons who are African American, Hispanic, Asian American, American Indian or Alaskan native, defined as follows:

African American: a person having origins in any of the black racial groups of Africa

Hispanic: a person of Mexican, Puerto Rican, Central or South American or other non-European Spanish culture or origin regardless of race.

Asian: a person having origins in any of the original peoples of the Far East, South East Asia, Indian subcontinent, Hawaii or the Pacific Islands.

American Indian or Alaskan Native: a person having origins in any of the original peoples of North America and who maintains cultural identification through tribal affiliation or community recognition.

Woman Business Enterprise

Woman Business Enterprise means a business which is a sole proprietorship, partnership or corporation at least 51% of which is owned and controlled by a woman or women.

OFFICE OF EQUAL EMPLOYMENT OPPORTUNITY/AFFIRMATIVE ACTION COPY

Minority/Woman Business Enterprise (MWBE) Questionnaire for Bidders

Jersey City Ordinance C-829 establishes a goal of awarding 20% of the dollar amount of total city procurement to minority and woman owned business enterprises.

To assist us in monitoring our achievement of this goal, please indicate below whether your company is or is not a minority owned and/or woman owned business, and return this form with your bid proposal.

Business Name : J. A. Alexander Inc.

Address : 130 John F. Kennedy Dr. No. Bloomfield, NJ 07003

Telephone No. : 973-680-0220

Contact Name : Jose D. Rebirebas

Please check applicable category :

Minority Owned Business (MBE)

Minority & Woman Owned Business (MWBE)

Woman Owned business (WBE)

Neither

Definitions:

Minority Business Enterprise

Minority Business Enterprise means a business which is a sole proprietorship, partnership or corporation at least 51% of which is owned and controlled by persons who are African American, Hispanic, Asian American, American Indian or Alaskan native, defined as follows:

African American: a person having origins in any of the black racial groups of Africa

Hispanic: a person of Mexican, Puerto Rican, Central or South American or other non-European Spanish culture or origin regardless of race.

Asian: a person having origins in any of the original peoples of the Far East, South East Asia, Indian subcontinent, Hawaii or the Pacific Islands.

American Indian or Alaskan Native: a person having origins in any of the original peoples of North America and who maintains cultural identification through tribal affiliation or community recognition.

Woman Business Enterprise

Woman Business Enterprise means a business which is a sole proprietorship, partnership or corporation at least 51% of which is owned and controlled by a woman or women.

DIVISION OF PURCHASING COPY

Form MWBE Contractor's Compliance Plan to be submitted with bid document.

CONTRACTOR: PROVIDE TWO (2) COMPLETED COPIES OF THIS FORM WITH YOUR PROPOSAL (or within 24 hours thereafter)

City of Jersey City
Department of Administration
Office of Equal Opportunity/Affirmative Action

Project: Buena Road and Phillip ST IMPROVEMENTS 11-020

Contractor: J. A. Alexander Inc. Bid Amt. \$ 1,154,302.02

Please list what portions of the work, if any you intend to sublet, the approximate value of the same, and whether you anticipate subletting it to a minority or woman owned contractor, or neither.

Trade	Approx. \$ Value	Minority or Woman Owned Business Check appropriate column		
		Minority	Woman	Neither
Electric	\$			✓
Guide Rail	\$			✓

Receipt of this report by the City does not constitute acceptance by the City of minority business participation goals less than 20% or women business participation goals less than 20% unless specifically agreed to by the Office of Equal Opportunity/Affirmative Action

CONTINUED ON NEXT PAGE.

OFFICE OF EQUAL EMPLOYMENT OPPORTUNITY/AFFIRMATIVE ACTION COPY

Form MWBE Contractor's Compliance Plan to be submitted with bid document.
CONTRACTOR: PROVIDE TWO (2) COMPLETED COPIES OF THIS FORM WITH YOUR PROPOSAL (or within 24 hours thereafter)

**City of Jersey City
 Department of Administration
 Office of Equal Opportunity/Affirmative Action**

Project: Buerhard and Phillip ST Improvements # 11-020

Contractor: J.A. Alexander Inc. Bid Amt. \$ 1,154,302.02

Please list what portions of the work, if any you intend to subcontract, the approximate value of the same, and whether you anticipate subcontracting it to a minority or woman owned contractor, or neither.

Trade	Approx. \$ Value	Minority or Woman Owned Business Check appropriate column		
		Minority	Woman	Neither
Electric	\$			✓
Guide Rail	\$			✓

Receipt of this report by the City does not constitute acceptance by the City of minority business participation goals less than 20% or women business participation goals less than 20% unless specifically agreed to by the Office of Equal Opportunity/Affirmative Action

CONTINUED ON NEXT PAGE

DIVISION OF PURCHASING COPY

MWBE Page 3 Project Buena Rd and Phillip St Improvements

2. As to subcontracted trade mandated to be included in proposal pursuant to N.J.S.A. 40A:11-16, please list name of proposed subcontractor, trade, and whether minority woman, or not:

Trade	Contractor Name & Address	Approx \$ Value	Minority or Woman Owned Business		
			Check appropriate column		
			Minority	Woman	Neither
Electric	Faison Electric 141 11th St Piscataway, NJ	\$10,000.00			✓
Guide Rail	RCOR Co. LLC P.O. Box 65 Cedarburg, NJ	\$130,000.00			✓

3. What is your policy and practice with respect to outreach and consideration of minority and women-owned vendors/contractors as contractors and/or suppliers?

We Give Every business the equal opportunity to work with us.
We'll Accept quotes from all business that meet State Requirements.

Name of Contractor J. A. Alexander Inc.

By: Signature _____

Type or print name/title: Jose D. Belirbas, President

Telephone No: 973-680-0220 Date 6-12-14

For City Use:

Acceptable M/W Business Participation levels for this Project: _____

By _____

Date: _____

EQUAL EMPLOYMENT OPORTUNITY COPY

MWBE Page 3 Project BURKEA Rd and Phillip St IMPROVEMENTS

2. As to subcontracted trade mandated to be included in proposal pursuant to N.J.S.A. 40A:11-16, please list name of proposed subcontractor, trade, and whether minority woman, or not:

Trade	Contractor Name & Address	Approx. \$ Value	To Minority or Woman Owned Business		
			Check appropriate column		
			Minority	Woman	Neither
Electric	Faigon Electric 141 11th St Piscataway, NJ	\$10,000.00			✓
Guide Rail	Faicor Co LLC PO Box 65 Ogdensburg, NJ	\$130,000.00			✓

3. What is your policy and practice with respect to outreach and consideration of minority and women-owned vendors/contractors as contractors and/or suppliers?

We Give every business the opportunity to work with us
We'll Accept Quotes from all business that meet state
Requirements.

Name of Contractor J A Alexander Inc.

By: Signature [Signature]

Type or print name/title: Jose J. Rehirbas, Pres.

Telephone No: 973-680-0220 Date 6-12-14

For City Use:

Acceptable M/W Business Participation levels for this Project: _____

By _____

Date: _____

PURCHASING COPY

Resolution of the City of Jersey City, N.J.

City Clerk File No. Res. 14.498
 Agenda No. 10.Z.5
 Approved: JUL 16 2014



TITLE:

RESOLUTION APPOINTING CARLO ABAD AS (1) A FULL-TIME JUDGE AND (2) DESIGNATING AS CHIEF JUDGE OF THE JERSEY CITY MUNICIPAL COURT

COUNCIL offered and moved adoption of the following resolution:

WHEREAS, pursuant to N.J.S.A. 2B:12-4(b), the Honorable Steven M. Fulop, Mayor of the City of Jersey City, has advised the Municipal Council by letter dated June 30, 2014, that he has appointed Carlo Abad of 60 Riverview Road, Jersey City, New Jersey as a full-time Judge of the Municipal Court, for a term to commence upon adoption of this resolution and expire three (3) years thereafter; and

WHEREAS, pursuant N.J.S.A. 2B:12-8 and §23-8 of the Jersey City Municipal Code, the Honorable Steven M. Fulop has also advised the Municipal Council in the same letter, that he has designated Carlo Abad as Chief Judge of the Municipal Court of the City of Jersey City; and

WHEREAS, the appointment and designation require the advise and consent of the Municipal Council.

NOW, THEREFORE, BE IT RESOLVED by the Municipal Council of the City of Jersey City that:

1. The appointment of Carlo Abad as a full-time Judge of the Municipal Court of the City of Jersey City for a three (3) year term to commence on the date of the within resolution, is hereby consented to pursuant to N.J.S.A. 2B:12-4(b).
2. The designation of Judge Carlo Abad as the Chief Judge, is hereby consented to pursuant to N.J.S.A. 2B:12-8 and §23-8 of the Jersey City Municipal Code.

TZ/igp
6/27/14

APPROVED: _____

APPROVED AS TO LEGAL FORM

APPROVED: _____
 Business Administrator

 Corporation Counsel

Certification Required

Not Required

APPROVED 9-0

RECORD OF COUNCIL VOTE ON FINAL PASSAGE 7.16.14											
COUNCILPERSON	AYE	NAY	N.V.	COUNCILPERSON	AYE	NAY	N.V.	COUNCILPERSON	AYE	NAY	N.V.
GAJEWSKI	✓			YUN	✓			RIVERA	✓		
RAMCHAL	✓			OSBORNE	✓			WATTERMAN	✓		
BOGGIANO	✓			COLEMAN	✓			LAVARRO, PRES	✓		

✓ Indicates Vote

N.V.-Not Voting (Abstain)

Adopted at a meeting of the Municipal Council of the City of Jersey City N.J.

 Rolando R. Lavarro, Jr., President of Council

 Robert Byrne, City Clerk

RESOLUTION FACT SHEET – NON-CONTRACTUAL

This summary sheet is to be attached to the front of any resolution that is submitted for Council consideration. Incomplete or vague fact sheets will be returned with the resolution.

Full Title of Ordinance/Resolution

RESOLUTION APPOINTING CARLO ABAD AS (1) A FULL-TIME JUDGE AND (2) DESIGNATING AS CHIEF JUDGE OF THE JERSEY CITY MUNICIPAL COURT

Initiator

Department/Division	Mayor's	
Name/Title	Steven M. Fulop	Mayor
Phone/email	201-547-5200	

Note: Initiator must be available by phone during agenda meeting (Wednesday prior to council meeting @ 4:00 p.m.)

Resolution Purpose

Appointment of a full-time Judge and Chief Judge of the Jersey City Municipal Court.

I certify that all the facts presented herein are accurate.

Signature of Department Director

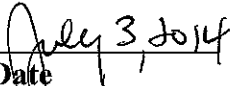
Date



STEVEN M. FULOP
MAYOR OF JERSEY CITY

**CITY OF JERSEY CITY
DEPARTMENT OF LAW**

CITY HALL • 280 GROVE STREET • JERSEY CITY, NJ 07302
PHONE (201) 547-5229 • FAX (201) 547-5230



JEREMY FARRELL
CORPORATION COUNSEL

July 2, 2014

Council President and Members of the Municipal Council
280 Grove Street
Jersey City, NJ 07302

Re: Reappointment of Chief Municipal Court Judge

Dear Council President and Members of the Municipal Council:

Pursuant to N.J.S.A. 2B:12-4(b), I hereby reappoint the Honorable Carlo Abad, a resident of Jersey City, to be a full-time judge of the municipal court for a term to commence on July 17, 2014 and expire three (3) years thereafter.

Further, pursuant to N.J.S.A. 2B:12-8 and §23-8 of the Jersey City Municipal Code, I designate the Honorable Carlo Abad as Chief Judge of the Municipal Court of the City of Jersey City. A copy of his resume is attached.

In accordance with the aforementioned provisions, I respectfully request the advice and consent of the Municipal Council to this designation.

Very truly yours,

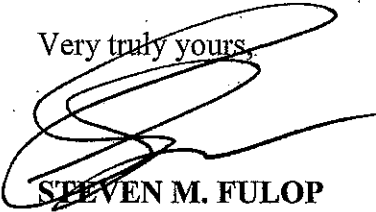
STEVEN M. FULOP
Mayor

TZ/igp

cc: Robert Byrne, City Clerk

Resolution of the City of Jersey City, N.J.

City Clerk File No. Res. 14.499
 Agenda No. 10.Z.6
 Approved: JUL 16 2014



TITLE:

RESOLUTION APPOINTING HANNAH H. IGLESIAS AS A MEMBER OF THE ETHICAL STANDARDS BOARD OF THE CITY OF JERSEY CITY

Council as a whole, offered and moved adoption of the following resolution:

WHEREAS, Hannah H. Iglesias, is a resident of the City of Jersey City; and

WHEREAS, Hannah H. Iglesias, has been chosen by virtue of her known and consistent reputation for integrity and knowledge of local government affairs; and

WHEREAS, Mayor Steven M. Fulop reviewed the qualifications of Hannah H. Iglesias and recommended her appointment as a member of the Ethical Standards Board of the City of Jersey City, replacing Nino S. Domingo, who has resigned, by letter dated July 3, 2014; and

WHEREAS, the Council has reviewed the qualifications of Hannah H. Iglesias and considers her well qualified to serve as a member of the Ethical Standards Board of the City of Jersey City.

NOW, THEREFORE, BE IT RESOLVED, that the Municipal Council of the City of Jersey City that:

1. The appointment of **Hannah H. Iglesias** as a member of the Ethical Standards Board of the City of Jersey City is hereby consented to and confirmed pursuant to N.J.S.A. 40A:9-22.19(a).
2. Her term of office shall expire on May 10, 2015.

G:\WPDOCS\BOARDS\ETHICAL\Hannah H Iglesias - Resolution.wpd

APPROVED: _____

APPROVED AS TO LEGAL FORM

APPROVED: _____

Business Administrator

Corporation Counsel

Certification Required

Not Required

APPROVED 9-0

RECORD OF COUNCIL VOTE ON FINAL PASSAGE 7.16.14											
COUNCILPERSON	AYE	NAY	N.V.	COUNCILPERSON	AYE	NAY	N.V.	COUNCILPERSON	AYE	NAY	N.V.
GAJEWSKI	✓			YUN	✓			RIVERA	✓		
RAMCHAL	✓			OSBORNE	✓			WATTERMAN	✓		
BOGGIANO	✓			COLEMAN	✓			LAVARRO, PRES	✓		

✓ Indicates Vote

N.V.-Not Voting (Abstain)

Adopted at a meeting of the Municipal Council of the City of Jersey City N.J.

Rolando R. Lavarro, Jr., President of Council

Robert Byrne, City Clerk



CITY OF JERSEY CITY

STEVEN M. FULOP, MAYOR

Report of Directors
8.f
Meeting 07.16.14

July 3, 2014

President and Members of the Municipal Council
City of Jersey City
280 Grove Street
Jersey City, New Jersey 07302

Dear President and Members,

Kindly be advised that I have appointed **Hannah H. Iglesias**, of 339 Fourth Street, Jersey City, New Jersey, 07302, **Democrat**, to serve as a member of the **Jersey City Ethical Standards Board**, replacing Nino S. Domingo, who has resigned. Ms. Iglesias's term will commence upon the adoption of a resolution and will expire May 10, 2015.

I respectfully request your advice and consent on this matter.

Sincerely,

A handwritten signature in black ink, appearing to read "Steven M. Fulop".

Steven M. Fulop
Mayor

c: Jeremy Farrell, Corporation Counsel
Robert Kakoleski, Business Administrator
Robert Byrne, City Clerk
Muhammed Akil, Chief of Staff
Nancy Warlikowski, Mayor's Office
Hannah H. Iglesias

OFFICE OF THE MAYOR
CITY HALL
280 GROVE STREET
JERSEY CITY, NJ 07302

P: 201 547 5200
F: 201 547 5442

WWW.JERSEYCITYNJ.GOV

Resolution of the City of Jersey City, N.J.

City Clerk File No. Res. 14.500
 Agenda No. 10.Z.7
 Approved: JUL 16 2014



TITLE:

RESOLUTION REAPPOINTING NICHOLAS JAYME AS A MEMBER OF THE ETHICAL STANDARDS BOARD OF THE CITY OF JERSEY CITY

Council as a whole, offered and moved adoption of the following resolution:

WHEREAS, Nicholas Jayme, is a resident of the City of Jersey City; and

WHEREAS, Nicholas Jayme, has been chosen by virtue of his known and consistent reputation for integrity and knowledge of local government affairs; and

WHEREAS, Mayor Steven M. Fulop reviewed the qualifications of **Nicholas Jayme** and recommended his reappointment as a member of the Ethical Standards Board of the City of Jersey City, by letter dated June 19, 2014; and

WHEREAS, the Council has reviewed the qualifications of **Nicholas Jayme** and considers him well qualified to serve as a member of the Ethical Standards Board of the City of Jersey City.

NOW, THEREFORE, BE IT RESOLVED, that the Municipal Council of the City of Jersey City that:

1. The reappointment of **Nicholas Jayme** as a member of the Ethical Standards Board of the City of Jersey City is hereby consented to and confirmed pursuant to N.J.S.A. 40A:9-22.19(a).
2. His term of office shall expire on May 10, 2019.

G:\WPDOCS\BOARDS\ETHICAL\Nicholas Jayme - Resolution.wpd

APPROVED: _____ APPROVED AS TO LEGAL FORM _____
 APPROVED: Gregory Konrad Business Administrator _____ Corporation Counsel _____
 Certification Required
 Not Required APPROVED 9-0

RECORD OF COUNCIL VOTE ON FINAL PASSAGE 7.16.14											
COUNCILPERSON	AYE	NAY	N.V.	COUNCILPERSON	AYE	NAY	N.V.	COUNCILPERSON	AYE	NAY	N.V.
GAJEWSKI	✓			YUN	✓			RIVERA	✓		
RAMCHAL	✓			OSBORNE	✓			WATTERMAN	✓		
BOGGIANO	✓			COLEMAN	✓			LAVARRO, PRES	✓		

✓ Indicates Vote

N.V.-Not Voting (Abstain)

Adopted at a meeting of the Municipal Council of the City of Jersey City N.J.

Rolando R. Lavarro, Jr.
 Rolando R. Lavarro, Jr., President of Council

Robert Byrne
 Robert Byrne, City Clerk



CITY OF JERSEY CITY

STEVEN M. FULOP, MAYOR

Report of Directors
8.a
Meeting 07.16.14

June 19, 2014

President and Members of the Municipal Council
City of Jersey City
280 Grove Street
Jersey City, New Jersey 07302

Dear President and Members,

Kindly be advised that I have reappointed **Nicholas Jayme**, of 159 Custer Avenue, Jersey City, New Jersey, 07305, **Undeclared**, to serve as a member of the **Jersey City Ethical Standards Board**. Mr. Jayme's term will commence upon the adoption of a resolution and will expire May 10, 2019.

I respectfully request your advice and consent on this matter.

Sincerely,

A handwritten signature in black ink, appearing to read "Steven M. Fulop".

Steven M. Fulop
Mayor

c: Jeremy Farrell, Corporation Counsel
Robert Kakoleski, Business Administrator
Robert Byrne, City Clerk
Muhammed Akil, Chief of Staff
Nancy Warlikowski, Mayor's Office
Nicholas Jayme

OFFICE OF THE MAYOR
CITY HALL
280 GROVE STREET
JERSEY CITY, NJ 07302

P: 201 547 5200
F: 201 547 5442

WWW.JERSEYCITYNJ.GOV

Nicholas Jayme

Objective

To further my skills and abilities with policy making and representing the peoples interest.

Experience

2001-Present
NJ

Owens Corning

South Kearny,

Chief Shop Steward/Electrical Tech

- Active member with in Teamster Local 560.
- Represent 60 members within the facility under a Collective Bargaining Contract between Owens Corning and Teamster Local 560.
- Successful negotiated a contract agreement on December 3rd 2007; which is up for re negotiations at the end of this year.
- Have interpreted the Collective Bargaining Agreement to meet the needs of members that are covered under the contract which I signed and negotiated with my constituents.
- Debated issues concerning my member's needs and concerns before the grievance procedure was taken in to action.
- Within 2 years I have handle over 20 formal grievances that lead to a compromise with the Company to meet the needs of the members that I represent.
- I have represented members of my Unit that have been processed for suspensions and terminations, but there charges were unjust and disciplinary actions were minimal. No members have been terminated.
- Troubleshoot and maintain electrically and mechanically shingle making machinery.

2009-Present
Owner

Nicholas Jayme General Contracting

NJ

- Growing Contracting Company that has generated business in an economic recession.
- I manage and maintain my Company with negotiating rates to meet my customer's needs and expectations.
- Planned and budgeted multiple projects to meet the need of the customers.
- Extraordinary craftsmanship from my Company has delivered numerous contracts which have retained pre existing customers business as well as generated new business.

1997-2001 United States Navy All Over

Electricians Mate

- Received Honorable discharge on November 5th 2001
- Served in two wars
- Received Citations for my performances and craftsmanship.
- Supervised and developed junior electricians within my department.

1995-1997 The Pet Company Jersey City ,NJ

Assistant Manager/Sales

- Manager in Training.

Education

2006-Present Hudson County Community College, Jersey City, NJ

- Working on AS degree for electrical engineering.
- Minor in Political Science

Organizations

- Active member of the Free and Accepted Masons
- International Brotherhood of Teamsters (under Teamster local 560)
- PCUE
- Phi Theta Kappa Honor Society at HCCC
- American Legion

Resolution of the City of Jersey City, N.J.

City Clerk File No. Res. 14.501
 Agenda No. 10.Z.8
 Approved: JUL 16 2014
 TITLE:



RESOLUTION APPOINTING MARY BLOOM AS A MEMBER OF THE ETHICAL STANDARDS BOARD OF THE CITY OF JERSEY CITY

Council as a whole, offered and moved adoption of the following resolution:

WHEREAS, Mary Bloom, is a resident of the City of Jersey City; and

WHEREAS, Mary Bloom, has been chosen by virtue of her known and consistent reputation for integrity and knowledge of local government affairs; and

WHEREAS, Mayor Steven M. Fulop reviewed the qualifications of **Mary Bloom** and recommended her appointment as a member of the Ethical Standards Board of the City of Jersey City, replacing Jeannie Dolan Pagano, who has resigned, by letter dated July 3, 2014; and

WHEREAS, the Council has reviewed the qualifications of **Mary Bloom** and considers her well qualified to serve as a member of the Ethical Standards Board of the City of Jersey City.

NOW, THEREFORE, BE IT RESOLVED, that the Municipal Council of the City of Jersey City that:

1. The appointment of **Mary Bloom** as a member of the Ethical Standards Board of the City of Jersey City is hereby consented to and confirmed pursuant to N.J.S.A. 40A:9-22.19(a).
2. Her term of office shall expire on May 10, 2016.

G:\WPDOCS\BOARDS\ETHICAL\Mary Bloom - Resolution.wpd

APPROVED: _____

APPROVED AS TO LEGAL FORM

APPROVED: _____
 Business Administrator

 Corporation Counsel

Certification Required

Not Required

APPROVED 9-0

RECORD OF COUNCIL VOTE ON FINAL PASSAGE 7.16.14											
COUNCILPERSON	AYE	NAY	N.V.	COUNCILPERSON	AYE	NAY	N.V.	COUNCILPERSON	AYE	NAY	N.V.
GAJEWSKI	✓			YUN	✓			RIVERA	✓		
RAMCHAL	✓			OSBORNE	✓			WATTERMAN	✓		
BOGGIANO	✓			COLEMAN	✓			LAVARRO, PRES	✓		

✓ Indicates Vote

N.V.-Not Voting (Abstain)

Adopted at a meeting of the Municipal Council of the City of Jersey City N.J.

 Rolando R. Lavarro, Jr., President of Council

 Robert Byrne, City Clerk



CITY OF JERSEY CITY

STEVEN M. FULOP, MAYOR

Report of Directors
8.g
Meeting 07.16.14

July 3, 2014

President and Members of the Municipal Council
City of Jersey City
280 Grove Street
Jersey City, New Jersey 07302

Dear President and Members,

Kindly be advised that I have appointed **Mary Bloom**, of 24 College Drive, Apt. 1E, Jersey City, New Jersey, 07305, **Republican**, to serve as a member of the **Jersey City Ethical Standards Board**, replacing Jeannie Dolan Pagano, who has resigned. Ms. Bloom's term will commence upon the adoption of a resolution and will expire May 10, 2016.

I respectfully request your advice and consent on this matter.

Sincerely,

A handwritten signature in black ink, appearing to read "Steven M. Fulop".

Steven M. Fulop
Mayor

c: Jeremy Farrell, Corporation Counsel
Robert Kakoleski, Business Administrator
Robert Byrne, City Clerk
Muhammed Akil, Chief of Staff
Nancy Warlikowski, Mayor's Office
Mary Bloom

OFFICE OF THE MAYOR
CITY HALL
280 GROVE STREET
JERSEY CITY, NJ 07302

P: 201 547 5200
F: 201 547 5442

WWW.JERSEYCITYNJ.GOV

CITY OF JERSEY CITY
Office of the City Clerk
280 Grove Street
Jersey City, New Jersey 07302

Robert Byrne, F.M.C., City Clerk
Sean J. Gallagher, F.M.C., Deputy City Clerk
Tolanda Griffin-Ross, Deputy City Clerk



Telephone: (201) 547-5150
Fax: (201) 547-5461

APPLICATION FOR MUNICIPAL PUBLIC SERVICE

Date: 6-26-2014

I, hereby apply to perform public service on the following municipal authorities, boards or commissions:

- a) Board of Ethics
- b) _____
- c) _____

Name: MARY Bloom

Address of Residence: 24 COLLEGE DR - 1E - JC NJ 07305

Phone Number: 201-424-7045

E-mail Address: maryo bloom @ yahoo. com

Education related to the authorities, boards or commissions of choice:

1967 Associates Degree - Tombrock College, West Paterson NJ

Volunteer or work related experience which could be of use to the authorities, boards or commissions of choice:

Worked as a legal secretary for 33 years before retiring - DeSevo + Lombardi, Chason Leyner, Terramiah Healy, Alston + Khorazian,

Mark C. Curtis, Esq.

Previous meeting attendance at, or volunteer work for, the authorities, boards or commissions of choice:

Volunteer Steve Fulop's Mayoral Campaign -

Worked out of Ward Cis / Nidia Lopez + Elmer + Main Office

Signature: Mary Bloom

Application for Municipal Public Service.wpd

Resolution of the City of Jersey City, N.J.

City Clerk File No. Res. 14.502

Agenda No. 10.Z.9

Approved: JUL 16 2014

TITLE:



**RESOLUTION APPOINTING DARRELL LAVAL
AS A MEMBER OF THE JERSEY CITY ALCOHOLIC
BEVERAGE CONTROL BOARD**

COUNCIL

OFFERED AND MOVED ADOPTION OF THE FOLLOWING RESOLUTION:

WHEREAS, the Honorable Steven M. Fulop, Mayor, by letter dated July 3, 2014, has advised the Municipal Council that he has appointed **Darrell Laval (Democrat)** of 140 Wade Street, Jersey City, New Jersey, 07305, as a member of the **Jersey City Alcoholic Beverage Control Board**, to replace Frank Pabon, whose term has expired, for a term to commence upon adoption of this resolution and expire June 30, 2017.

NOW, THEREFORE, BE IT RESOLVED, by the Municipal Council of the City of Jersey City, that the appointment of **Darrell Laval** as a **Member** of the **Jersey City Alcoholic Beverage Control Board**, for the above-mentioned term is hereby advised and consented to pursuant to law.

RB:sjg

APPROVED: _____

APPROVED AS TO LEGAL FORM

APPROVED: _____

Business Administrator

Corporation Counsel

Certification Required

Not Required

APPROVED 9-0

RECORD OF COUNCIL VOTE ON FINAL PASSAGE 7.16.14											
COUNCILPERSON	AYE	NAY	N.V.	COUNCILPERSON	AYE	NAY	N.V.	COUNCILPERSON	AYE	NAY	N.V.
GAJEWSKI	✓			YUN	✓			RIVERA	✓		
RAMCHAL	✓			OSBORNE	✓			WATTERMAN	✓		
BOGGIANO	✓			COLEMAN	✓			LAVARRO, PRES	✓		

✓ Indicates Vote

N.V.-Not Voting (Abstain)

Adopted at a meeting of the Municipal Council of the City of Jersey City N.J.

Rolando R. Lavarro, Jr., President of Council

Robert Byrne, City Clerk



CITY OF JERSEY CITY

STEVEN M. FULOP, MAYOR

Report of Directors
8.h
Meeting 07.16.14

July 3, 2014

President and Members of the Municipal Council
City of Jersey City
280 Grove Street
Jersey City, New Jersey
07302

Dear Council President and Members,

Kindly be advised that I have appointed **Darrell G. Laval**, a **Democrat**, of 140 Wade Street, Jersey City, New Jersey, 07305 to serve as a member of the **Jersey City Alcoholic Beverage Control Board**. Mr. Laval is replacing Frank Pabon, whose term has expired, for a term to commence upon the adoption of a resolution and expire on June 30, 2017.

I respectfully request your advice and consent to this appointment.

Sincerely,

A handwritten signature in black ink, appearing to read "Steven M. Fulop".

Steven M. Fulop
Mayor

OFFICE OF THE MAYOR
CITY HALL
280 GROVE STREET
JERSEY CITY, NJ 07302

P: 201 547 5200
F: 201 547 5442

WWW.JERSEYCITYNJ.GOV

c: Jeremy Farrell Corporation Counsel
Robert Kakoleski, Business Administrator
Robert Byrne, City Clerk
Maynard Woodson, Director, Div. of Commerce
Rachael Riccio, Secretary, A. B. C. Board
Muhammed Akil, Chief of Staff
Nancy Warlikowski, Mayor's Office
Darrell G. Laval

Darrell G. Laval, Sr.
140 Wade Street
Jersey City, New Jersey 07305
Home (201) 433-6215 – Work (917) 763-2973
(201) 892-2151 - Cellular
Darrell.Laval@aol.com

SUMMARY OF QUALIFICATIONS

Over 28 years of extensive experience in working with the public housing sector; effective communicator; adept in public relations working with Resident Councils to improve better quality housing; demonstrates strength in projecting high-level motivation, problem solving and decision-making; analyzes situations and handles problems confidentially with expediency and efficiency. Excellent interpersonal and communication skills.

PROFESSIONAL EXPERIENCE

NEW YORK CITY HOUSING AUTHORITY (NYCHA)

2010- Present

Deputy Director/Acting Director, Brooklyn Property Management

- Serve as Acting Boro Director to approximately 1500 subordinate staff, including 48 property Managers and 48,000 public housing units, in the absence of the Boro Director
- Supervise eight public housing developments: Coney Island (3), Brooklyn (5) totaling over 10,983 units daily
- Plan, review key performance indicators (KPI'S, rent collection/delinquency, vacancy turnaround, prep time, annual reviews, work order turnaround time) with Property Manager's and Housing Assistants
- Assist Capitol Projects Department with over \$100 million in capital improvements for eight developments located in Coney Island and Brooklyn
- Assist New York City Police Department (PSA 1, Housing Unit) who patrols New York City Housing Authority's 336 buildings, with a total of 600,000 residents
- Coordinate Public Housing Assessment System Inspections (PHAS) with HUD REAC Center., resulting in being the only Deputy in Brooklyn to pass all inspections in five years
- Attend Tenant Association monthly meetings: Presidents, residents, local officials, PSA 1, Housing Unit and Executive staff.

JERSEY CITY HOUSING AUTHORITY

2003 – 2009

Director: Real Estate & Asset Management

- Provide leadership to subordinate staff (all Site Managers) and enforce performance and conduct standards in a professional manner.
- Supervise approximately 2500 low-income public housing units.
- Plan, direct and evaluate the effectiveness of Site Manager's operations and the training development of staff.

- Assist in the preparation of annual and five-year plans on the agency goals and achievements.
- Communicate clearly, orally and in writing presentations at all Jersey City Housing Authority (JCHA) Board of Commissioners Meetings.
- Direct and support Site Managers in the area of PHAS and REAC Scores including, but not limited to, vacancy turnaround, emergency work orders and inspections.

1995 – 2001

Assistant Director of Management

- Assisted the Director of Management in the overall planning administration and management of three (3) large housing developments: Lafayette Gardens – 490 units; Pre-Hope VI Site; A. Harry Moore Apartments – 664 units; Demolition of three (3) high-rise buildings at A. Harry Moore Apartments; Curries Woods – 712 units, Hope VI Site since 1991 and Leased Housing – 70 unit.
- Supervised Public Housing Drug Elimination Program (PHDEP) of all off-duty police officers working in our developments.
- Coordinated and monitored the long/short range planning and implementation of a substantial Relocation program under the Federal Uniform Relocation Act at Curries Woods.
- Successfully relocated more than 300 – plus low-income public residents through our Section 8 Program.
- Prepared suitable reports and supervised the maintenance of resident's records and files.
- Assisted in the rental of apartments to incoming residents and oversaw the review of resident's income to ascertain their rental payments.
- Handled socio-economic problems among residents and assisted in promoting recreational and social activities in conjunction with other outside agencies.
- Supervised staff of 125 employees responsible for maintenance, plumbing, electrical, carpentry and plastering of twelve public housing developments.
- Spearheaded and re-organized Resident Council organizations to improve existing living conditions.
- Occasionally attended court or eviction proceedings for non-payment of rent and lease violations.
- Maintained supervision of maintenance of buildings and grounds, both exterior and interior in the absence of the Director of Management, assumed the responsibility of overall management functions of all public housing developments.

1985 – 1995

Public Housing Manager

- Managed 712 units, including a staff of twenty or more employees for maintenance, plumbing, electrical and carpentry.
- Evaluated and determined the proper actions to be taken; implemented the corrective actions such as; tenant complaints, apartment break-ins, violence, non-payment of rent and drug-related problems.
- Assisted in the handling of site budget of \$32 million received from the Department of

Housing and Urban Development (HUD) for the site Revitalization Plan under the HOPE (Home Opportunities for People Everywhere) VI Program.

- Supervised Public Housing Drug Elimination Program (PHDEP) for off-duty police security for Curries Woods.
- Coordinated \$250,000 for relocation purposes at Curries Woods under the Federal Uniform Relocation Act as described in the Federal Register.

EDUCATION

1991- St. Peter's College, Jersey City, NJ

Bachelor of Science Degree: Urban Studies

SPECIAL RECOGNITION

2004 – 2009: State Assembly Aid

2002 – 2004: Alcohol Beverage Control (ABC) Commissioner

1985 – 2002: Business Director of Greenville Steering Committee Affordable Housing Corporation, non-profit group

1985-1997: Councilman Aid

1981 – 2004: Ward A Leader

CITY OF JERSEY CITY
Office of the City Clerk
280 Grove Street
Jersey City, New Jersey 07302

Robert Byrne, R.M.C., City Clerk
Sean J. Gallagher, R.M.C., Deputy City Clerk
Tolonda Griffin-Ross, Deputy City Clerk

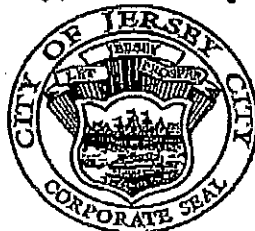

Telephone: (201) 547-5150
Fax: (201) 547-5481

APPLICATION FOR MUNICIPAL PUBLIC SERVICE

Date: 7/7/14

I, hereby apply to perform public service on the following municipal authorities, boards or commissions:

- a) ABC Board
- b) _____
- c) _____

Name: Darrell Laval, Sr.

Address of Residence: 140 Wade Street

Phone Number: 917-763-2973 Cell 201-433-6215 Home

E-mail Address: DarrellLaval1@aol.com

Education related to the authorities, boards or commissions of choice:

BS Degree: Urban Studies - St. Peter's College

Volunteer or work related experience which could be of use to the authorities, boards or commissions of choice:

Prior ABC Commissioner

Previous meeting attendance at, or volunteer work for, the authorities, boards or commissions of choice:

Salvation Army Chairperson - 3/08 - 5/14 Volunteer Work

Signature: Darrell Laval Sr.

Resolution of the City of Jersey City, N.J.

City Clerk File No. Res. 14.503

Agenda No. 10.Z.10

Approved: JUL 16 2014

TITLE:



RESOLUTION REAPPOINTING COUNCILPERSON DIANE COLEMAN AS A MEMBER OF THE JERSEY CITY REDEVELOPMENT AGENCY

COUNCIL OFFERED AND MOVED ADOPTION OF THE FOLLOWING RESOLUTION:

WHEREAS, the Honorable Steven M. Fulop, Mayor of the City of Jersey City, has advised the Municipal Council by letter dated July 3, 2014, that he has reappointed **Councilperson Diane Coleman**, of 59 Arlington Avenue, Jersey City, New Jersey, as a member of the **Jersey City Redevelopment Agency**, for a period to commence immediately and expire on June 30, 2015.

NOW, THEREFORE, BE IT RESOLVED, by the Municipal Council of the City of Jersey City, that the reappointment of **Councilperson Diane Coleman** as a member of the **Jersey City Redevelopment Agency** for the above-mentioned term is hereby advised and consented to pursuant to law.

RB:sjg

APPROVED: [Signature] APPROVED AS TO LEGAL FORM
 Business Administrator Corporation Counsel
 Certification Required
 Not Required **APPROVED 9-0**

RECORD OF COUNCIL VOTE ON FINAL PASSAGE 7.16.14											
COUNCILPERSON	AYE	NAY	N.V.	COUNCILPERSON	AYE	NAY	N.V.	COUNCILPERSON	AYE	NAY	N.V.
GAJEWSKI	✓			YUN	✓			RIVERA	✓		
RAMCHAL	✓			OSBORNE	✓			WATTERMAN	✓		
BOGGIANO	✓			COLEMAN	✓			LAVARRO, PRES	✓		

✓ Indicates Vote N.V.-Not Voting (Abstain)

Adopted at a meeting of the Municipal Council of the City of Jersey City N.J.

[Signature]
 Rolando R. Lavarro, Jr., President of Council

[Signature]
 Robert Byrne, City Clerk



CITY OF JERSEY CITY

STEVEN M. FULOP, MAYOR

Report of Directors
8.i
Meeting 07.16.14

July 3, 2014

President and Members of the Municipal Council
280 Grove Street
City of Jersey City
Jersey City, N.J. 07302

Dear President and Members,

Kindly be advised that I have reappointed **Councilperson Diane Coleman**, of 59 Arlington Avenue, Jersey City, New Jersey, 07305 as a member of the **Jersey City Redevelopment Agency**. Her term will commence immediately upon the adoption of a resolution and will expire on June 30, 2015.

I respectfully request your advice and consent on this matter.

Very Truly Yours,

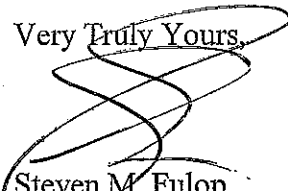
Steven M. Fulop
Mayor

c: Jeremy Farrell, Corporation Counsel
Robert Kakoleski, Business Administrator
Robert Byrne, City Clerk
Barbara Amato, Secretary, J.C. Redevelopment Agency
Muhammed Akil, Chief of Staff
Nancy Warlikowski, Mayor's Office
Diane Coleman., Councilperson, Ward F

OFFICE OF THE MAYOR
CITY HALL
280 GROVE STREET
JERSEY CITY, NJ 07302

P: 201 547 5200
F: 201 547 5442

WWW.JERSEYCITYNJ.GOV

Resolution of the City of Jersey City, N.J.

City Clerk File No. Res. 14.504
 Agenda No. 10.Z.11
 Approved: JUL 16 2014
 TITLE:



RESOLUTION REAPPOINTING COUNCIL PRESIDENT ROLANDO R. LAVARRO, JR. AS A MEMBER OF THE JERSEY CITY REDEVELOPMENT AGENCY

COUNCIL OFFERED AND MOVED ADOPTION OF THE FOLLOWING RESOLUTION:

WHEREAS, the Honorable Steven M. Fulop, Mayor of the City of Jersey City, has advised the Municipal Council by letter dated July 3, 2014, that he has reappointed **Council President Rolando R. Lavarro, Jr.**, of 56 Culver Avenue, Jersey City, New Jersey, 07305 as a member of the **Jersey City Redevelopment Agency**, for a period to commence immediately and expire on June 30, 2015.

NOW, THEREFORE, BE IT RESOLVED, by the Municipal Council of the City of Jersey City, that the reappointment of **Council President Rolando R. Lavarro, Jr.** as a member of the **Jersey City Redevelopment Agency** for the above-mentioned term is hereby advised and consented to pursuant to law.

RB:sjg

APPROVED: [Signature]
 APPROVED: [Signature]
 Business Administrator

APPROVED AS TO LEGAL FORM
[Signature]
 Corporation Counsel
 Certification Required
 Not Required

APPROVED 9-0

RECORD OF COUNCIL VOTE ON FINAL PASSAGE 7.16.14											
COUNCILPERSON	AYE	NAY	N.V.	COUNCILPERSON	AYE	NAY	N.V.	COUNCILPERSON	AYE	NAY	N.V.
GAJEWSKI	✓			YUN	✓			RIVERA	✓		
RAMCHAL	✓			OSBORNE	✓			WATTERMAN	✓		
BOGGIANO	✓			COLEMAN	✓			LAVARRO, PRES	✓		

✓ Indicates Vote

N.V.-Not Voting (Abstain)

Adopted at a meeting of the Municipal Council of the City of Jersey City N.J.

[Signature]
 Rolando R. Lavarro, Jr., President of Council

[Signature]
 Robert Byrne, City Clerk



CITY OF JERSEY CITY

STEVEN M. FULOP, MAYOR

Report of Directors
8.j
Meeting 07.16.14

July 3, 2014

President and Members of the Municipal Council
280 Grove Street
City of Jersey City
Jersey City, N.J. 07302

Dear President and Members,

Kindly be advised that I have reappointed **Council President Rolando R. Lavarro, Jr.**, of 56 Culver Avenue, Jersey City, New Jersey, 07305, as a member of the **Jersey City Redevelopment Agency**. His term will commence immediately upon the adoption of a resolution and will expire on June 30, 2015.

I respectfully request your advice and consent on this matter.

Very Truly Yours,



Steven M. Fulop
Mayor

c: Jeremy Farrell, Corporation Counsel
Robert Kakoleski, Business Administrator
Robert Byrne, City Clerk
Barbara Amato, Secretary, J.C. Redevelopment Agency
Muhammed Akil, Chief of Staff
Nancy Warlikowski, Mayor's Office
Rolando R. Lavarro, Jr., Council President

OFFICE OF THE MAYOR
CITY HALL
280 GROVE STREET
JERSEY CITY, NJ 07302

P: 201 547 5200
F: 201 547 5442

WWW.JERSEYCITYNJ.GOV

Resolution of the City of Jersey City, N.J.

City Clerk File No. Res. 14.505

Agenda No. 10.Z.12

Approved: JUL 16 2014



TITLE:

A RESOLUTION AUTHORIZING THE CLOSING OF A MUNICIPAL STREET(S), BOTH GARRISON AVENUE FROM PAVONIA AVENUE TO STUYVESANT AVENUE, WITH SIP AVENUE KEPT OPEN AND BOND STREET BEGINNING NOON AND ENDING 8:00 P.M. SATURDAY, JULY 26, 2014 (RAIN DATE; SATURDAY, AUGUST 2, 2014) AT THE REQUEST OF THE UPPER GARRISON NEIGHBORHOOD ASSOCIATION FOR THE PURPOSE OF A BLOCK PARTY

WHEREAS, the Division of Architecture, Engineering, Traffic and Transportation has received an application from the Upper Garrison Neighborhood Association to close both Garrison Avenue from Pavonia Avenue to Stuyvesant Avenue, with Sip Avenue kept open, and Bond Street beginning Noon and ending 8:00 p.m. Saturday, July 26, 2014 (rain date: Saturday, August 2, 2014) for the purpose of a block party; and

WHEREAS, in accordance with the provisions of Section 296-71 and 296-72, a street may be temporarily closed for a block party or any recreational event to be conducted within an area not exceeding one city block under certain conditions;

WHEREAS, when one or more of the required conditions for a street closing are not met, in accordance with Sections 296-74 (B) the Director of Architecture, Engineering, Traffic and Transportation may recommend to the City Council that one or more of the requirements of Sections 296-71, 296-72 and 296-73 be waived; and

WHEREAS, the request to close both Garrison Avenue and Bond Street does not meet one or more of the requirements set forth in Sections 296-71 (A)(B)(C)(D) and 296-73(D) as the event as the event is sponsored by a non-resident for three of the four blocks and more than one block at a time will be closed; and

WHEREAS, the closing of the aforementioned streets will not affect public safety or convenience, and in accordance with the provision of Section 296-74 (B) and the applicant has made a request to the City Council that the aforementioned requirements set forth in Sections 296-71 and 296-73 be waived.

NOW THEREFORE BE IT RESOLVED, that the Municipal Council via adoption of this resolution authorizes the closing of both Garrison Avenue from Pavonia Avenue to Stuyvesant Avenue, with Sip Avenue kept open, and Bond Street beginning Noon and ending 8:00 p.m. Saturday, July 26 2014 (rain date: Saturday, August 2, 2014).

APPROVED: 
Director of Traffic & Transportation

APPROVED: 
Director, Architecture, Engineering, Traffic and Transportation

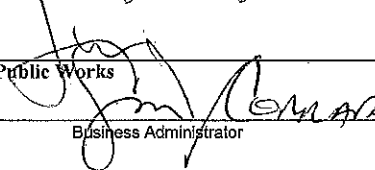
APPROVED: 
Director, Dept. of Public Works

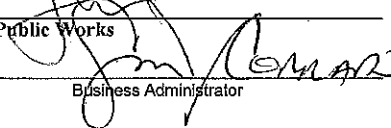
APPROVED: 
Business Administrator

APPROVED AS TO LEGAL FORM

Corporation Counsel

JDS:pcl
(06.24.14)

Certification Required

Not Required

APPROVED 9-0

RECORD OF COUNCIL VOTE ON FINAL PASSAGE 7.16.14											
COUNCILPERSON	AYE	NAY	N.V.	COUNCILPERSON	AYE	NAY	N.V.	COUNCILPERSON	AYE	NAY	N.V.
GAJEWSKI	✓			YUN	✓			RIVERA	✓		
RAMCHAL	✓			OSBORNE	✓			WATTERMAN	✓		
BOGGIANO	✓			COLEMAN	✓			LAVARRO, PRES.	✓		

✓ Indicates Vote

N.V.-Not Voting (Abstain)

Adopted at a meeting of the Municipal Council of the City of Jersey City N.J.

Rolando R. Lavarro, Jr., President of Council

Robert Byrne, City Clerk

RESOLUTION FACT SHEET – NON-CONTRACTUAL

This summary sheet is to be attached to the front of any ordinance that is submitted for Council consideration. Incomplete or vague fact sheets will be returned with the resolution.

Full Title of Resolution

A RESOLUTION AUTHORIZING THE CLOSING OF A MUNICIPAL STREET(S), BOTH GARRISON AVENUE FROM PAVONIA AVENUE TO STUYVESANT AVENUE, WITH SIP AVENUE KEPT OPEN AND BOND STREET BEGINNING NOON AND ENDING 8:00 P.M. SATURDAY, JULY 26, 2014 (RAIN DATE; SATURDAY, AUGUST 2, 2014) AT THE REQUEST OF THE UPPER GARRISON NEIGHBORHOOD ASSOCIATION FOR THE PURPOSE OF A BLOCK PARTY

Initiator

Department/Division	Public Works	Architecture, Engineering, Traffic and Transportation
Name/Title	Joao D'Souza at the request of Hector Velasquez on behalf of the Upper Garrison Neighborhood Association, 77 Garrison Avenue, JCNJ 07306, 718.809.4540	Director of Traffic & Transportation
Phone/email	201.547.4470	JOAO@jcnj.org

Note: Initiator must be available by phone during agenda meeting (Wednesday prior to council meeting @ 4:00 p.m.)

Resolution Purpose

AUTHORIZING THE CLOSING OF BOTH GARRISON AVENUE FROM PAVONIA AVENUE TO STUYVESANT AVENUE, WITH SIP AVENUE KEPT OPEN AND BOND STREET BEGINNING NOON AND ENDING 8:00 P.M. SATURDAY, JULY 26, 2014 (RAIN DATE; SATURDAY, AUGUST 2, 2014) AT THE REQUEST OF THE UPPER GARRISON NEIGHBORHOOD ASSOCIATION FOR THE PURPOSE OF A BLOCK PARTY

Any costs incurred as a result of the street closing will be the responsibility of the Organization hosting the event.

I certify that all the facts presented herein are accurate.



Signature of Department Director

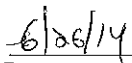

Date

RECREATIONAL EVENT STREET CLOSURE

BLOCKS: GARRISON AV from PAVONIA AV to STUYVESANT AV,
with SIP AV kept open;
BOND ST

PURPOSE OF EVENT: block party

BEGINS: Noon ENDS: 8PM
Saturday, July 26 (rain date August 2), 2014

APPLICANT: Hector Velasquez

ORGANIZATION : Upper Garrison Neighborhood Association

ADDRESS: 77 Garrison Av

CITY, STATE, ZIP: Jersey City NJ 07306

PHONE #: 718.809.4540

BEING WAIVED: More than one block at a time closed, nonresident of some blocks

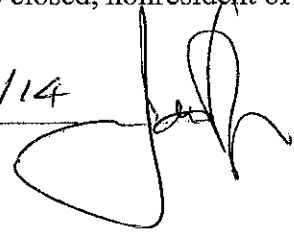
APPROVED Ok DATE 6/23/14 

DENIED _____ DATE _____

PLEASE REVIEW WITH ME _____ DATE _____

20

21

34

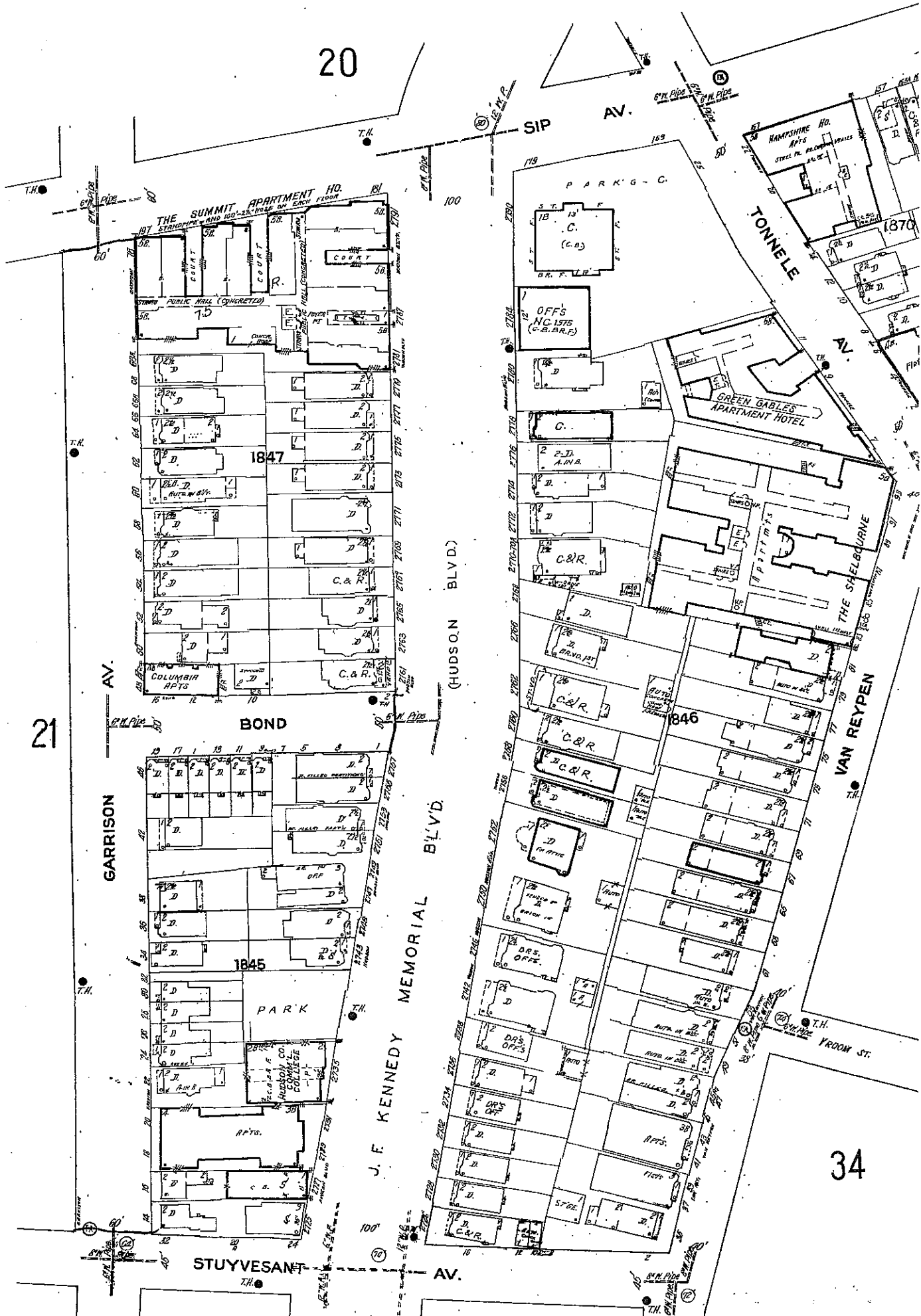



22

PAVONIA AV.

16

19

ROMAINE ST. & 8TH AV.

GARRISON AV.

MAGNOLIA AV.

TONNELE

UNITED M.E. CHURCH

J.F. KENNEDY MEMORIAL BLVD. (HUDSON BLVD.)

SIP AV.

18

21

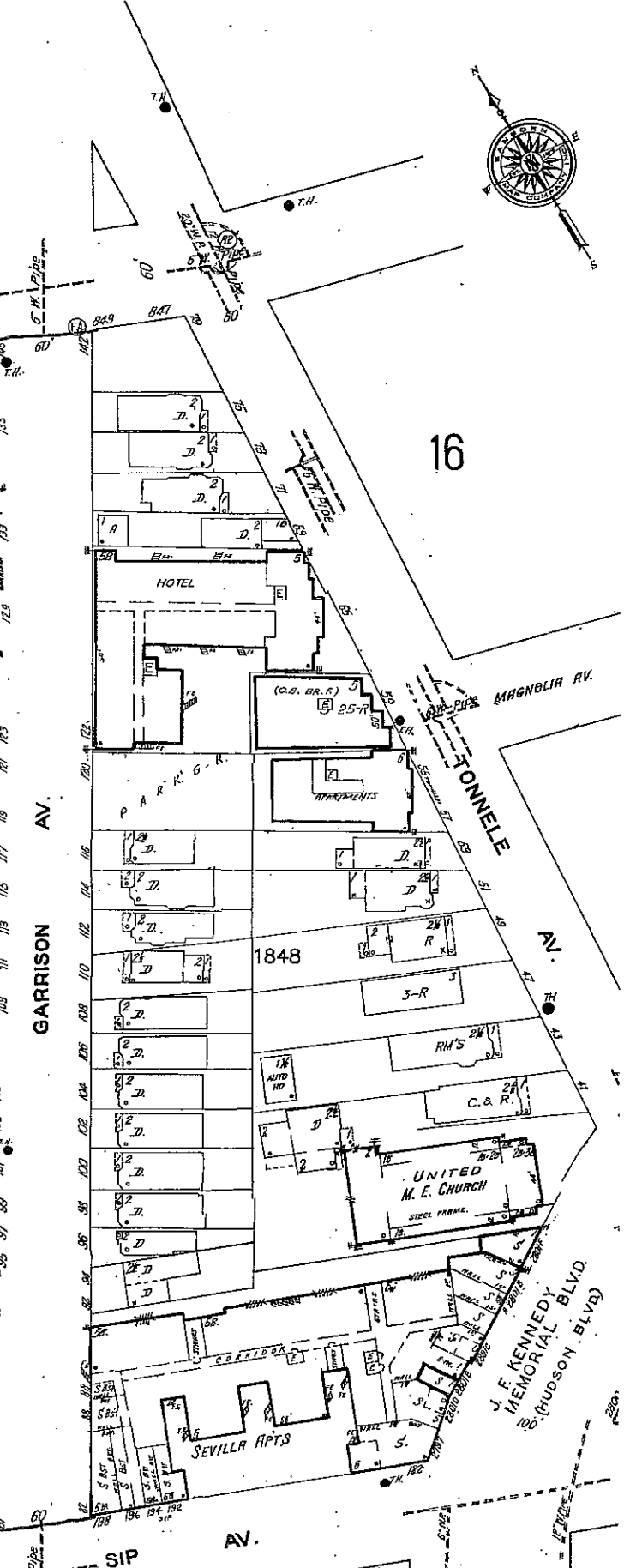
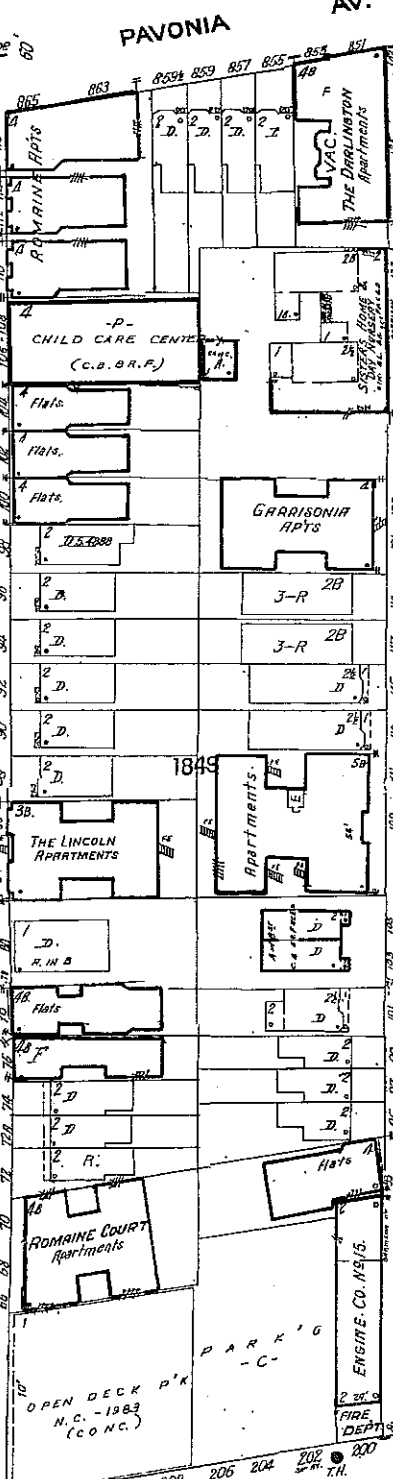
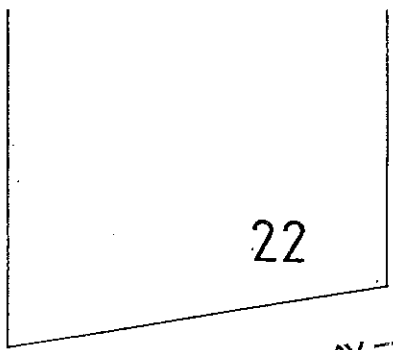

8" M. Pipe
6" M. Pipe
60'

6" M. Pipe
60'

6" M. Pipe
6" M. Pipe
60'

6" M. Pipe
60'

OPEN DECK P'K
N.C. - 1963
(CONC.)

PARKING - C

ENGINE CO. NO. 15
FIRE DEPT

SEVILLA APTS

UNITED M.E. CHURCH
STEEL FRAME

C. & R.

R.M.'S

1848

P.A.R.K.

HOTEL

GARRISON APTS

CHILD CARE CENTER
(C.C.B.R.F.)

THE DARLINGTON
APARTMENTS

ROMAINE APTS

Resolution of the City of Jersey City, N.J.

City Clerk File No. Res. 14.506

Agenda No. 10.Z.13

Approved: JUL 16 2014



TITLE:

**RESOLUTION AUTHORIZING THE CLOSING OF A MUNICIPAL STREET(S),
POPLAR STREET FROM SUMMIT AVENUE TO CENTRAL AVENUE
BEGINNING 1:00 P.M. AND ENDING 10:00 P.M., SATURDAY, AUGUST 2 AND
SUNDAY, AUGUST 3, 2014 AT THE REQUEST OF THE CHURCH OF LILY OF
THE VALLEY FOR THE PURPOSE OF A CHURCH SERVICE**

WHEREAS, the Division of Architecture, Engineering, Traffic and Transportation has received an application from the Church of Lily of the Valley to close Poplar Street from Summit Avenue to Central Avenue beginning 1:00 p.m. and ending 10:00 p.m. on Saturday, August 2 and Sunday, August 3, 2014 for the purpose of a Church service; and

WHEREAS, in accordance with the provisions of Section 296-71 and 296-72 and Chapter 122-8, a street may be temporarily closed for a block party or any recreational event to be conducted within an area not exceeding one city block under certain conditions;

WHEREAS, when one or more of the required conditions for a street closing are not met, in accordance with Sections 296-74 (B) the Director of Architecture, Engineering, Traffic and Transportation may recommend to the City Council that one or more of the requirements of Sections 296-71, 296-72 and 296-73 and Chapter 122-8 be waived; and

WHEREAS, the request to close Poplar Street does not meet one or more of the requirements set forth in Section 296-71(A)(B)(C)(D) and 296-73(D) and Chapter 122-8(A)(C) as the application for the street closing has been filed by a nonresident and the end time exceeds what is permitted; and

WHEREAS, the closing of the aforementioned street will not affect public safety or convenience, and in accordance with the provision of Section 296-74 (B) the applicant has made a request to the City Council that the aforementioned requirements set forth in Section 296-71, 296-72 and 296-73 and Chapter 122-8 be waived.

NOW THEREFORE IS IT RESOLVED, that the Municipal Council via adoption of this resolution authorizes the closing of Poplar Street from Summit Avenue to Central Avenue beginning 1:00 p.m. and ending 10:00 p.m. on Saturday, August 2 and Sunday, August 3, 2014

APPROVED:
Director of Traffic & Transportation

APPROVED:
Director, Architecture, Engineering, Traffic and Transportation

APPROVED:
Director, Dept. of Public Works

APPROVED:
Business Administrator

APPROVED AS TO LEGAL FORM

Corporation Counsel

Certification Required

Not Required

APPROVED 9-0

JDS:pcl
(06.24.14)

RECORD OF COUNCIL VOTE ON FINAL PASSAGE 7.16.14											
COUNCILPERSON	AYE	NAY	N.V.	COUNCILPERSON	AYE	NAY	N.V.	COUNCILPERSON	AYE	NAY	N.V.
GAJEWSKI	✓			YUN	✓			RIVERA	✓		
RAMCHAL	✓			OSBORNE	✓			WATTERMAN	✓		
BOGGIANO	✓			COLEMAN	✓			LAVARRO, PRES.	✓		

✓ Indicates Vote

N.V.-Not Voting (Abstain)

Adopted at a meeting of the Municipal Council of the City of Jersey City N.J.

Rolando R. Lavarro, Jr., President of Council

Robert Byrne, City Clerk

RESOLUTION FACT SHEET – NON-CONTRACTUAL

This summary sheet is to be attached to the front of any ordinance that is submitted for Council consideration. Incomplete or vague fact sheets will be returned with the resolution.

Full Title of Resolution

RESOLUTION AUTHORIZING THE CLOSING OF A MUNICIPAL STREET(S), POPLAR STREET FROM SUMMIT AVENUE TO CENTRAL AVENUE BEGINNING 1:00 P.M. AND ENDING 10:00 P.M., SATURDAY, AUGUST 2 AND SUNDAY, AUGUST 3, 2014 AT THE REQUEST OF THE CHURCH OF LILY OF THE VALLEY FOR THE PURPOSE OF A CHURCH SERVICE

Initiator

Department/Division	Public Works	Architecture, Engineering, Traffic and Transportation
Name/Title	Joao D'Souza at the request of Juliana Cedano on behalf of the Church of Lily of the Valley, 1146 Summit Av., JCNJ 07307	Director of Traffic & Transportation
Phone/email	201.547.4470	JOAO@cnj.org

Note: Initiator must be available by phone during agenda meeting (Wednesday prior to council meeting @ 4:00 p.m.)

Resolution Purpose

AUTHORIZING THE CLOSING OF POPLAR STREET FROM SUMMIT AVENUE TO CENTRAL AVENUE BEGINNING 1:00 P.M. AND ENDING 10:00 P.M., SATURDAY, AUGUST 2 AND SUNDAY, AUGUST 3, 2014 AT THE REQUEST OF THE CHURCH OF LILY OF THE VALLEY FOR THE PURPOSE OF A CHURCH SERVICE

Any costs incurred as a result of the street closing will be the responsibility of the Organization hosting the event.

I certify that all the facts presented herein are accurate.



Signature of Department Director

Date

RECREATIONAL EVENT STREET CLOSURE

BLOCK: POPLAR ST from SUMMIT to CENTRAL AVS

PURPOSE OF EVENT: church service

BEGINS: 1PM ENDS: 10PM
Saturday and Sunday, August 2 & 3, 2014

APPLICANT: Juliana Cedano

ORGANIZATION : Church of Lily of the Valley

ADDRESS: 1146 Summit Av

CITY, STATE, ZIP: Jersey City NJ 07307

PHONE #: 201.208.3712

BEING WAIVED: End time, nonresident

APPROVED ok

DATE 6/23/14

DENIED /

DATE _____

PLEASE REVIEW WITH ME _____ **DATE** _____

28

SUMMIT AV.

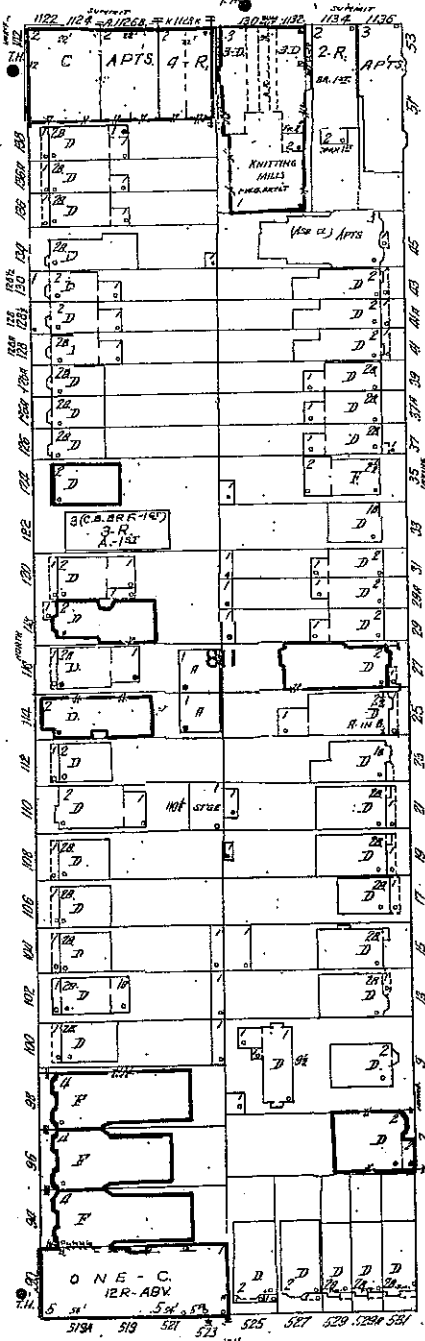
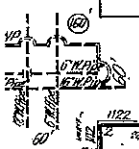

NORTH

IRVING

POPLAR

39

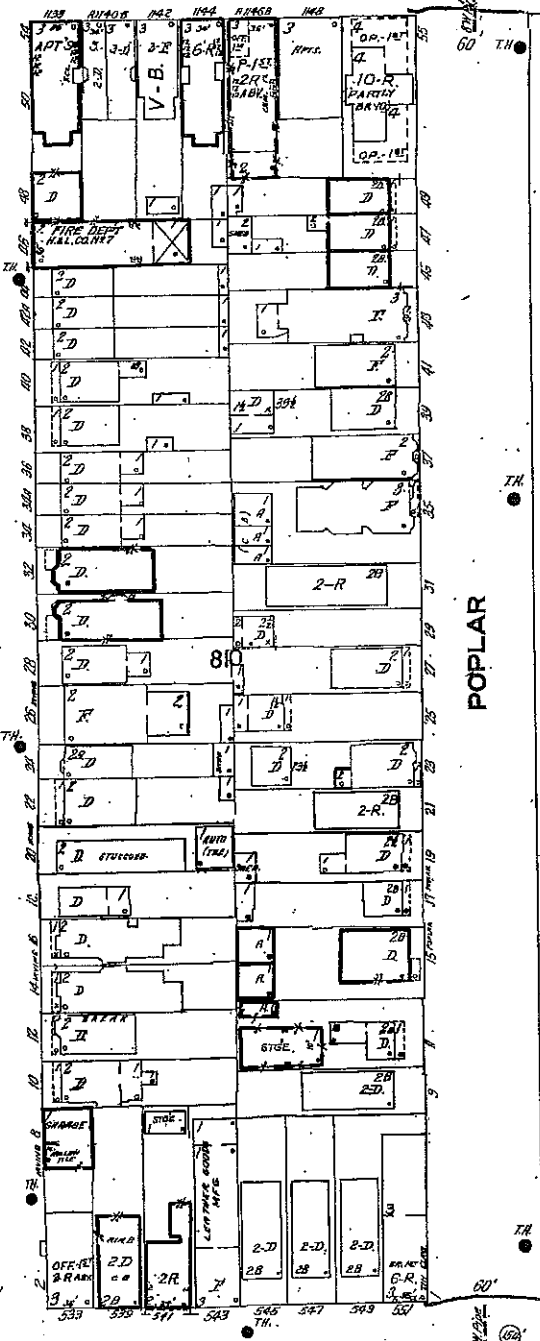

CENTRAL AV.

NORTH ST

49

Resolution of the City of Jersey City, N.J.

City Clerk File No. Res. 14.507

Agenda No. 10.Z.14

Approved: JUL 16 2014



TITLE:

**RESOLUTION AUTHORIZING THE CLOSING OF A MUNICIPAL STREET(S),
MAGNOLIA AVENUE FROM BALDWIN AVENUE TO CHESTNUT AVENUE
BEGINNING 6:00 P.M. AND ENDING 10:00 P.M., WEDNESDAY, SEPTEMBER
10, 2014 THROUGH SUNDAY, SEPTEMBER 14, 2014 AT THE REQUEST OF
SAINT JOSEPH RC CHURCH FOR THE PURPOSE OF AN ANNUAL PARISH
FESTIVAL**

WHEREAS, the Division of Architecture, Engineering, Traffic and Transportation has received an application from Saint Joseph RC Church to close Magnolia Avenue from Baldwin Avenue to Chestnut Avenue beginning 6:00 p.m. and ending 10:00 p.m., Wednesday, September 10, 2014 through Sunday, September 14, 2014 for the purpose of an annual Parish festival; and

WHEREAS, in accordance with the provisions of Section 296-71 and 296-72, a street may be temporarily closed for a block party or any recreational event to be conducted within an area not exceeding one city block under certain conditions;

WHEREAS, when one or more of the required conditions for a street closing are not met, in accordance with Sections 296-74 (B) the Director of Architecture, Engineering, Traffic and Transportation may recommend to the City Council that one or more of the requirements of Sections 296-71, 296-72, 296-73 and Section 122-8 be waived; and

WHEREAS, the request to close Magnolia Avenue does not meet one or more of the requirements set forth in Section 296-71(B)(D), 296-72(2), 296-73(D) and Section 122-8(A)(C) as the application has been submitted by a non-resident, the street closure will be held on a weekday and the event will end later than what is permitted; and

WHEREAS, the closing of the aforementioned street will not affect public safety or convenience, and in accordance with the provision of Section 296-74 (B) the applicant has made a request to the City Council that the aforementioned requirements set forth in Section 296-71, 296-72, 296-73 and Section 122-8 be waived.

NOW THEREFORE IS IT RESOLVED, that the Municipal Council via adoption of this resolution authorizes the closing of Magnolia Avenue from Baldwin Avenue to Chestnut Avenue beginning 6:00 p.m. and ending 10:00 p.m. on Wednesday, September 10, 2014 through Sunday, September 14, 2014.

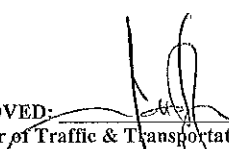
APPROVED: 
Director of Traffic & Transportation

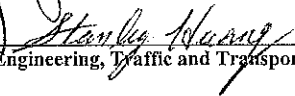
APPROVED: 
Director, Architecture, Engineering, Traffic and Transportation

APPROVED: 
Director, Dept. of Public Works

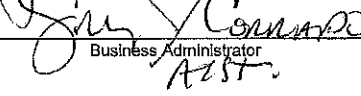
APPROVED: 
Business Administrator

APPROVED AS TO LEGAL FORM

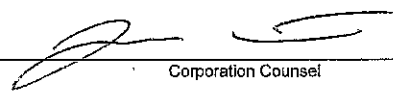
Corporation Counsel

JDS:pcl
(06.24.14)

Certification Required

Not Required

APPROVED 9-0

RECORD OF COUNCIL VOTE ON FINAL PASSAGE 7.16.14											
COUNCILPERSON	AYE	NAY	N.V.	COUNCILPERSON	AYE	NAY	N.V.	COUNCILPERSON	AYE	NAY	N.V.
GAJEWSKI	✓			YUN	✓			RIVERA	✓		
RAMCHAL	✓			OSBORNE	✓			WATTERMAN	✓		
BOGGIANO	✓			COLEMAN	✓			LAVARRO, PRES.	✓		

✓ Indicates Vote

N.V.-Not Voting (Abstain)

Adopted at a meeting of the Municipal Council of the City of Jersey City N.J.

Rolando R. Lavarro, Jr., President of Council

Robert Byrne, City Clerk

RESOLUTION FACT SHEET – NON-CONTRACTUAL

This summary sheet is to be attached to the front of any ordinance that is submitted for Council consideration. Incomplete or vague fact sheets will be returned with the resolution.

Full Title of Resolution

RESOLUTION AUTHORIZING THE CLOSING OF A MUNICIPAL STREET(S), MAGNOLIA AVENUE FROM BALDWIN AVENUE TO CHESTNUT AVENUE BEGINNING 6:00 P.M. AND ENDING 10:00 P.M., WEDNESDAY, SEPTEMBER 10, 2014 THROUGH SUNDAY, SEPTEMBER 14, 2014 AT THE REQUEST OF SAINT JOSEPH RC CHURCH FOR THE PURPOSE OF AN ANNUAL PARISH FESTIVAL

Initiator

Department/Division	Public Works	Architecture, Engineering, Traffic and Transportation
Name/Title	Joao D'Souza at the request of Rev James V Pagnotta on behalf of St. Joseph RC Church, 511 Pavonia Avenue, JCNJ 07306, 201.653.0392	Director of Traffic & Transportation
Phone/email	201.547.4470	JOAO@jcnj.org

Note: Initiator must be available by phone during agenda meeting (Wednesday prior to council meeting @ 4:00 p.m.)

Resolution Purpose

AUTHORIZING THE CLOSING OF MAGNOLIA AVENUE FROM BALDWIN AVENUE TO CHESTNUT AVENUE BEGINNING 6:00 P.M. AND ENDING 10:00 P.M., WEDNESDAY, SEPTEMBER 10, 2014 THROUGH SUNDAY, SEPTEMBER 14, 2014 AT THE REQUEST OF SAINT JOSEPH RC CHURCH FOR THE PURPOSE OF AN ANNUAL PARISH FESTIVAL

Any costs incurred as a result of the street closing will be the responsibility of the Organization hosting the event.

I certify that all the facts presented herein are accurate.



Signature of Department Director

Date

RECREATIONAL EVENT STREET CLOSURE

BLOCK: MAGNOLIA AV from BALDWIN to CHESTNUT AVS

PURPOSE OF EVENT: annual parish festival

BEGINS: 6PM ENDS: 10PM

Wednesday, Sept 10 through Sunday, Sept 14, 2014

APPLICANT: Rev James V Pagnotta

ORGANIZATION : St Joseph RC Church

ADDRESS: 511 Pavonia Av

CITY, STATE, ZIP: Jersey City NJ 07306

PHONE #: 201.653.0392

BEING WAIVED: Day of week, end time

APPROVED OK

DATE 6/23/14

DENIED _____

DATE _____

PLEASE REVIEW WITH ME _____ **DATE** _____

24

19

BALDWIN

AV.

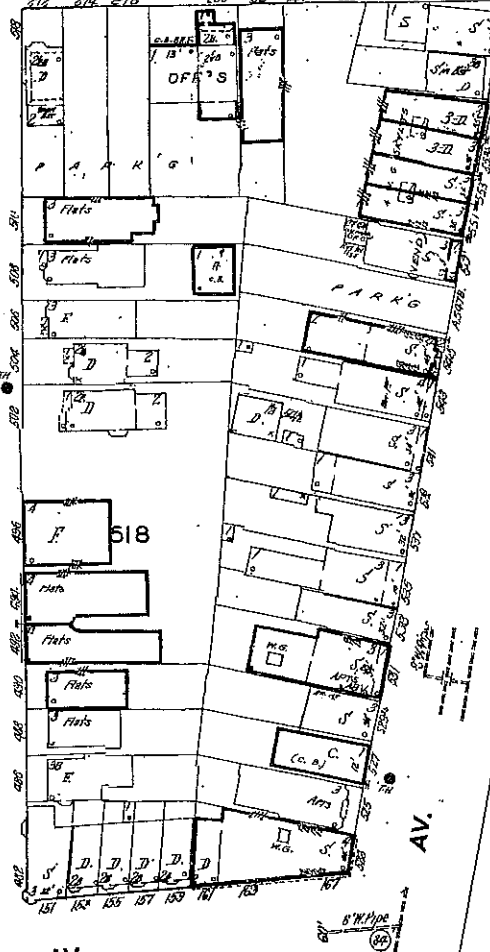
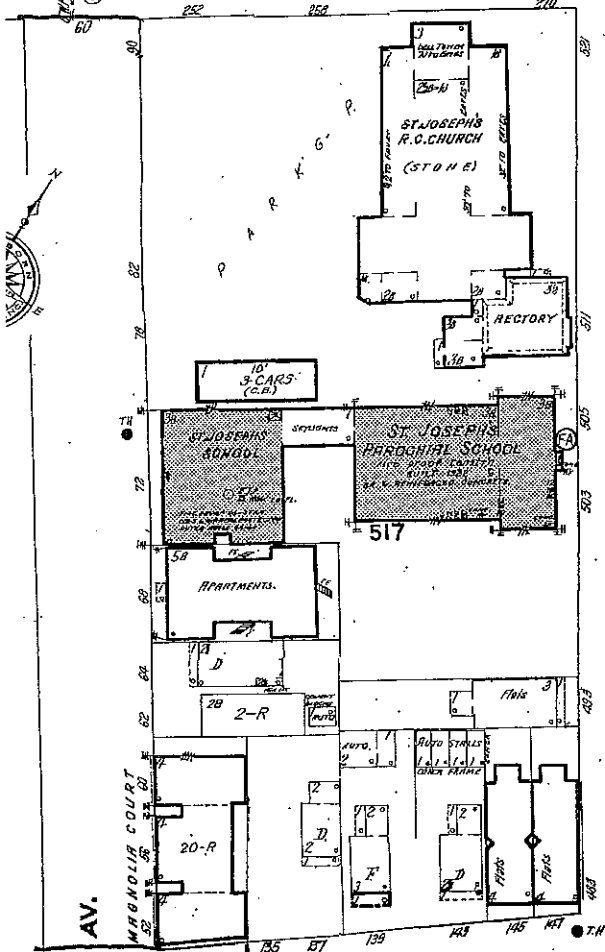

22

CHESTNUT

AV.

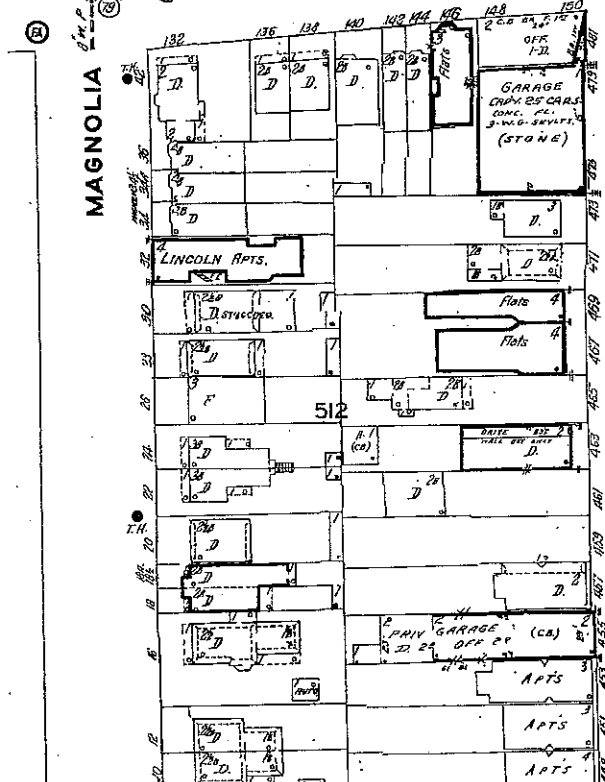

PAVONIA

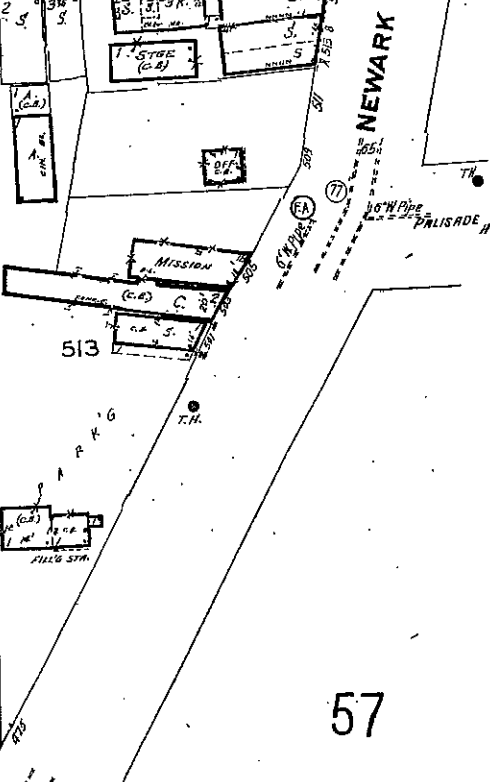

57

Resolution of the City of Jersey City, N.J.

City Clerk File No. _____ Res. 14.508

Agenda No. _____ 10.z.15

Approved: _____ JUL 16 2014



TITLE:

RESOLUTION CELEBRATING THE LIFE AND ACHIEVEMENTS OF Cornelius R. Parker Jr.

WHEREAS, Cornelius R. Parker Jr. was born in Jersey City, New Jersey on April 1, 1916. He attended Jersey City Public School No. 14 and graduated from Lincoln High School in 1934. He then attended the New York School of Embalming and Restorative Art. Cornelius owned and operated Parker's Funeral Home, a landmark at the corners of Clinton and Madison avenues that is now the Cotton-Parker Funeral Home. His father, the late Cornelius Sr., established the Parker Funeral Home in 1895 with over ten locations in New York City, before settling in Jersey City; and

WHEREAS, Cornelius R. Parker Jr. graduated as the youngest mortician in the state and the highest scorer on the prerequisite State Board Examinations in 1936, a year before his father passed away. At the young age of 21 Cornelius became the man of the family and helped his mother provide for his five younger siblings; and

WHEREAS, Cornelius R. Parker Jr. is important to the history of Jersey City. The devoted civil servant was the recipient of many awards, honors and accolades for his many years of distinguished professional and public service to the citizens of Jersey City. The lifelong member of Metropolitan A.M.E. Church was a member of the NAACP, the Jersey City Board of Education and the Jersey City Medical Center; and

WHEREAS, Cornelius R. Parker Jr. was committed to civil rights and was instrumental in arranging a visit from civil rights leader Reverend Dr. Martin Luther King Jr. in 1968. This visit was King's final public appearance. Following Dr. King's assassination, Cornelius was the first to recommend that the newly erected Public School No. 11 be named in his memory; and

WHEREAS, Cornelius R. Parker Jr. was instrumental in electing Jersey City's first African-American Ward F. Councilman, Fred Martin, as well as his successor William J. Thornton who served a term. Cornelius also faithfully served his community as Councilman of Ward F during the years 1977-1981; and

WHEREAS, Cornelius R. Parker Jr., longtime Jersey City businessman, former councilman and civil rights activist entered into eternal life on July 7, 2014 at the age of 98. He was predeceased by his lovely wife, the former Emma Weedon Parker and his son Cornelius III. He leaves to cherish his memories, his children James, Vernard, Veronica, Valerie, Victoria, Vanessa and Vonya ;

NOW, THEREFORE, BE IT RESOLVED, that the Municipal Council of the City of Jersey City on behalf of the citizenry does hereby celebrate the life and achievements of Cornelius R. Parker Jr., a great member of our city.

APPROVED: _____

APPROVED AS TO LEGAL FORM

APPROVED: _____
Business Administrator

_____ Corporation Counsel

Certification Required

Not Required

APPROVED 9-0

RECORD OF COUNCIL VOTE ON FINAL PASSAGE											
7.16.14											
COUNCILPERSON	AYE	NAY	N.V.	COUNCILPERSON	AYE	NAY	N.V.	COUNCILPERSON	AYE	NAY	N.V.
GAJEWSKI	✓			YUN	✓			RIVERA	✓		
RAMCHAL	✓			OSBORNE	✓			WATTERMAN	✓		
BOGGIANO	✓			COLEMAN	✓			LAVARRO, PRES	✓		

✓ Indicates Vote

N.V.-Not Voting (Abstain)

Adopted at a meeting of the Municipal Council of the City of Jersey City N.J.

Rolando R. Lavarro, Jr., President of Council

Robert Byrne, City Clerk

Resolution of the City of Jersey City, N.J.

City Clerk File No. _____ Res. 14.509

Agenda No. _____ 10.z.16

Approved: _____ JUL 16 2014

TITLE:



RESOLUTION AUTHORIZING A MEMORANDUM OF UNDERSTANDING WITH THE JERSEY CITY MUSEUM FOR THE PARTIES' JOINT COOPERATION IN THE PRESERVATION OF THE JERSEY CITY MUSEUM ART COLLECTION AND STAYING THE ASSOCIATED LITIGATION

COUNCIL
following resolution:

offered and moved adoption of the

WHEREAS, the Jersey City Museum ("Museum") is a nonprofit corporation that operates as a public museum providing art exhibitions and cultural education programs for the benefit of Jersey City residents; and

WHEREAS, the Museum's assets include an extensive collection of approximately 10,000 artworks (the "Collection") ranging in date from prior to the Colonial period to the present; and

WHEREAS, the Museum is experiencing financial hardship and seeking a place to store and display the art collection; and

WHEREAS, the Museum filed a lawsuit against the City of Jersey City ("City") on May 9, 2013 with docket number L-2234-13, and the City filed its answer and the litigation is currently pending; and

WHEREAS, the Museum and the City (collectively, the "Parties") have agreed to stay the litigation in exchange for the joint cooperation of the Parties to maintain and find a home for the collection; and

WHEREAS, the City desires to give the Museum the sum of \$45,000.00 to be used as follows: \$5,000.00 towards the Museum's insurance premiums and \$40,000.00 towards an updated inventory report and plan; and

WHEREAS, funds in the amount of \$45,000.00 are available in Account No. 01-201-20-111-314; and

NOW, THEREFORE, BE IT RESOLVED, by the Municipal Council of the City of Jersey City that:

1. Subject to such modifications as may be deemed necessary or appropriate by Corporation Counsel, the Mayor or Business Administrator is authorized to execute the Memorandum of Understanding, in substantially the form attached hereto.

City Clerk File No. _____

Agenda No. 10.z.16

TITLE:

RESOLUTION AUTHORIZING A MEMORANDUM OF UNDERSTANDING WITH THE JERSEY CITY MUSEUM FOR THE PARTIES' JOINT COOPERATION IN THE PRESERVATION OF THE JERSEY CITY MUSEUM ART COLLECTION AND STAYING THE ASSOCIATED LITIGATION

I hereby certify that funds in the amount of \$45,000.00 are available in Account No. 01-201-20-111-314 for payment of this resolution.

Donna Mauer, Chief Financial Officer

CR/kn

PO# 114137

APPROVED: _____

APPROVED AS TO LEGAL FORM

APPROVED:  Business Administrator

 Corporation Counsel

Certification Required

Not Required

APPROVED 9-0

RECORD OF COUNCIL VOTE ON FINAL PASSAGE											
7.16.14											
COUNCILPERSON	AYE	NAY	N.V.	COUNCILPERSON	AYE	NAY	N.V.	COUNCILPERSON	AYE	NAY	N.V.
GAJEWSKI	✓			YUN	✓			RIVERA	✓		
RAMCHAL	✓			OSBORNE	✓			WATTERMAN	✓		
BOGGIANO	✓			COLEMAN	✓			LAVARRO, PRES.	✓		

✓ Indicates Vote

N.V.-Not Voting (Abstain)

Adopted at a meeting of the Municipal Council of the City of Jersey City N.J.

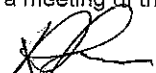
Rolando R. Lavarro, Jr., President of Council

Robert Byrne, City Clerk

RESOLUTION FACT SHEET – NON-CONTRACTUAL

This summary sheet is to be attached to the front of any resolution that is submitted for Council consideration. Incomplete or vague fact sheets will be returned with the resolution.

Full Title of Ordinance/Resolution

RESOLUTION AUTHORIZING A MEMORANDUM OF UNDERSTANDING WITH THE JERSEY CITY MUSEUM FOR THE PARTIES' JOINT COOPERATION IN THE PRESERVATION OF THE JERSEY CITY MUSEUM ART COLLECTION AND STAYING THE ASSOCIATED LITIGATION

Initiator

Department/Division	Law Department	
Name/Title	Jason Watson	First Assistant Corporation Counsel
Phone/email	(201) 547-4701	jwatson@jcnj.org

Note: Initiator must be available by phone during agenda meeting (Wednesday prior to council meeting @ 4:00 p.m.)

Resolution Purpose

For the City of Jersey City and the Jersey City Museum to work together to find a home for the art collection and stay the pending litigation.

I certify that all the facts presented herein are accurate.

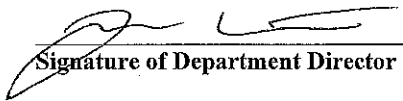
Signature of Department Director

7.9.14
Date

MEMORANDUM OF UNDERSTANDING

BETWEEN

JERSEY CITY MUSEUM

AND

CITY OF JERSEY CITY

I. Background, Purpose, and Scope.

1. The Jersey City Museum ("JCM") and City of Jersey City ("City"; collectively, the "Parties") enter into this Memorandum of Understanding ("MOU").

2. City is a municipality located in the State of New Jersey.

3. JCM is a nonprofit corporation incorporated under New Jersey law in 1991. JCM operates as a public museum and provides exhibits of art and cultural education programs. As memorialized in its By-Laws, JCM's mission includes "serv[ing] as a center of cultural life for the people of Jersey City, Hudson County and the region" ("Mission"). JCM's assets include an extensive collection of approximately 10,000 artworks ranging in date from prior to the Colonial period to present ("Collection"). A copy of the most current report outlining the Collection is attached hereto as **Exhibit A** (the "Report").

4. On May 9, 2013, JCM filed a suit against the City in the Superior Court of New Jersey, Law Division, Hudson County ("Court") with docket no. L-2234-13 (the "Litigation"). The City filed an answer in the Litigation and the matter is currently pending.

5. The Parties recognize that effective cooperation is important to protect the Collection. Accordingly, the purpose of this MOU is to identify the roles and responsibilities of each party as they relate to JCM's efforts to create and implement the Plan (defined below), resolve the Litigation, and to protect the Collection during this process.

II. JCM's Responsibilities Under this MOU.

1. In fulfillment of its Mission, by [date] JCM will develop a comprehensive long-term plan ("Plan") to reorganize its assets. The Plan may include, but is not limited to:

- a. creation of an updated inventory of the entire Collection ("Updated Report");
- b. the development of a new facility ("Facility") to exhibit part of the Collection with the assistance of the City;
- c. payment of JCM's current debts.

2. As needed, JCM may enter into a memorandum of understanding or similar agreement with William Patterson University ("WPU"), Hudson County Community College ("HCCC"), or similar such institution(s) with respect to:

- a. creation of the Updated Report;
- b. physical transfer of the Collection; and/or
- c. any other issue(s) as may be appropriate.

3. JCM may determine that as a part of its Plan it is in the best interest of its Mission that the Collection be held temporarily in whole or part by WPU, HCCC, and/or other appropriate institution located in Northern New Jersey. However, any such determination to this effect will be made after consultation with the City.

4. JCM will temporarily loan the City an appropriate piece from the Collection to be displayed in a safe and suitable location within Journal Square during the pendency of this MOU ("Journal Square Loaner Artwork").

III. City's Responsibilities Under this MOU.

1. City will reimburse JCM for premiums owed for continuation of its property, liability and similar insurance ("JCM Insurance Coverage") during the pendency of the MOU Period (defined below) in the sum of [\$5,000] as the Parties agree that continuation of the JCM Insurance Coverage is necessary to protect the Collection and in the best interest of both Parties.

2. The City will provide JCM with the sum of [\$40,000] on [date] which will be used for the creation of the Updated Report and/or implementation of the Plan.

3. By [date], City shall provide JCM with a list of properties that may be used for the Facility pursuant to the Plan.

4. The City agrees to obtain and pay for appropriate insurance coverage protecting against damage and/or theft of the Journal Square Loaner Artwork ("JSLA Insurance"). The City agrees that the JSLA Insurance will be obtained after consultation with JCM as to the appropriate amount and scope of coverage.

IV. Mutual Responsibilities of JCM and City Under this MOU.

1. The Parties agree to jointly to stay the Litigation for the duration of this MOU and to submit a consent order to this effect by no later than [date].

2. The Parties agree to work cooperatively towards the goals outlined in this MOU.

V. Effective Date, Duration, and Signature.

1. This MOU shall be effective upon the signature of authorized officials of JCM and the City.

2. This MOU shall be in force from January [], 2014 through [June __], 2014 (the "MOU Period"). The Parties may from time to time agree to amend this MOU in writing, including extending the MOU Period; provided that any such amendment will only become effective when executed by both Parties.

3. Either party may unilaterally terminate this MOU in writing, before the MOU Period end date, by delivering a termination notice to the other party via certified mail.

4. The Parties agree that upon termination of this MOU for any reason, the stay of the Litigation will be automatically lifted.

5. Nothing in this MOU creates or affords any rights or remedies to any party not a signatory to this MOU.

6. JCM and the City indicate agreement with this MOU by their signatures. This MOU may be executed in separate counterparts, each of which when executed and delivered will be deemed an original, an all of which when taken together will constitute one and the same MOU.

[printed name]

January __, 2014

[printed name]

January __, 2014

Resolution of the City of Jersey City, N.J.

City Clerk File No. Res. 14.510

Agenda No. 10.z.17

Approved: JUL 16 2014

TITLE:



RESOLUTION AUTHORIZING AN AWARD OF A CONTRACT TO CDW GOVERNMENT INC. FOR THE PURCHASE OF SYMANTEC ANTIVIRUS SOFTWARE FOR THE DEPARTMENT OF PUBLIC SAFETY, DIVISION OF FIRE THROUGH THE MIDDLESEX REGIONAL EDUCATIONAL SERVICES COMMISSION (MRESC)

COUNCIL AS A WHOLE, offered and moved adoption of the following Resolution:

WHEREAS, N.J.S.A. 40A:11-10 et. seq. authorizes a municipality to enter into a Cooperative Pricing Agreement with another public entity; and

WHEREAS, certain economies can be achieved when public entities purchase goods and services together under a cooperative pricing agreement; and

WHEREAS, the Middlesex Regional Educational Services Commission (MRESC) is a lead agency under a Cooperative Pricing Agreement approved by the Division of Local Government Services; and

WHEREAS, the Department of Public Safety, Division of Fire at 73-85 Bishop Street, is in need of Symantic Antivirus Software; and

WHEREAS, Resolution 14-097 approved on February 11, 2014 authorized the City of Jersey City (City) to enter into a Cooperative Agreement with the **Middlesex Regional Educational Services Commission (MRESC)**; and

WHEREAS, the Department of Public Safety, Division of Fire wishes to purchase a Symantic Antivirus Software for the Public Safety Building from CDW Government Inc. (CDW-G), 200 North Milwaukee Avenue, Vernon Hills, Illinois 60061; and

WHEREAS, the City Purchasing Agent has certified that he considers said proposal to be fair and reasonable; and

WHEREAS, the sum of Forty Thousand Eight Hundred Forty Two Dollars and Ninety Three (\$40,842.93) is available in the **Trust Fund Account 17-289-56-000-002**; and

Acct #: 17-289-56-000-002 **Amount:** \$40,842.93 **PO #:** 114162

WHEREAS, these funds are available for this expenditure in accordance with requirements of the Local Budget Law, N.J.S.A. 40A:4-1 et seq.;

NOW, THEREFORE, BE IT RESOLVED, by the Municipal Council of the City of Jersey City that the said proposal of the aforementioned CDW Government Inc. (CDW-G) be accepted and that a contract be awarded to said company in the above amount and the City Purchasing Agent is directed to have such a contract drawn up and executed; and be it further

RESOLVED, that upon certification by an official or employee of the City authorized to receive the material pursuant to the contract met, then payment to the contractor shall be made in accordance with the provisions of the Local Fiscal Affairs Law, N.J.S.A. 40A:5-1 et seq.; and be it further

(Continued on page 2)

TITLE:

RESOLUTION AUTHORIZING AN AWARD OF A CONTRACT TO CDW GOVERNMENT INC. FOR THE PURCHASE OF SYMANATIC ANTIVIRUS SOFTWARE FOR THE DEPARTMENT OF PUBLIC SAFETY, DIVISION OF FIRE THROUGH THE MIDDLESEX REGIONAL EDUCATIONAL SERVICES COMMISSION (MRESC)

RESOLVED, this contract shall be subject to the condition that the vendor/contractor provide satisfactory evidence of compliance with the Affirmative Action Amendments to the Law Against Discrimination, N.J.S.A. 10:5-31 et seq., and be it further

I, Donna Mauer, Donna Mauer, Chief Financial Officer, certify that there are sufficient funds available for payment of this above resolution.

Acct #: 17-289-56-000-002 Amount: \$40,842.93 PO #: 114162

APPROVED: [Signature]
 Peter Folgado, Director of Purchasing,
 OPA, RPPO

7/11/14
 Date

PF/pv
 7/11/14

APPROVED: [Signature] APPROVED AS TO LEGAL FORM
 APPROVED: [Signature] [Signature]
 Business Administrator ASST. Corporation Counsel
 Certification Required
 Not Required

APPROVED 9-0

RECORD OF COUNCIL VOTE ON FINAL PASSAGE 7.16.14											
COUNCILPERSON	AYE	NAY	N.V.	COUNCILPERSON	AYE	NAY	N.V.	COUNCILPERSON	AYE	NAY	N.V.
GAJEWSKI	✓			YUN	✓			RIVERA	✓		
RAMCHAL	✓			OSBORNE	✓			WATTERMAN	✓		
BOGGIANO	✓			COLEMAN	✓			LAVARRO, PRES.	✓		

✓ indicates Vote

N.V.-Not Voting (Abstain)

Adopted at a meeting of the Municipal Council of the City of Jersey City N.J.

[Signature]
 Rolando R. Lavarro, Jr., President of Council

[Signature]
 Robert Byrne, City Clerk

14-510

RESOLUTION FACT SHEET – NON-CONTRACTUAL

This summary sheet is to be attached to the front of any resolution that is submitted for Council consideration. Incomplete or vague fact sheets will be returned with the resolution.

Full Title of Ordinance/Resolution

RESOLUTION AUTHORIZING AN AWARD OF A CONTRACT TO CDW GOVERNMENT FOR THE PURCHASE OF SYMANTEC ANTI-VIRUS SOFTWARE FOR THE DEPARTMENT OF PUBLIC SAFETY (FIRE) THROUGH THE MIDDLESEX REGIONAL EDUCATIONAL SERVICES COMMISSION (MRESC)

Initiator

Department/Division	Public Safety	Division of Fire
Name/Title	James Shea	Director
Phone/email	201-547-4239	jshea@njcps.org

Note: Initiator must be available by phone during agenda meeting (Wednesday prior to council meeting @ 4:00 p.m.)

Resolution Purpose

This software package is necessary to protect the Department of Public Safety from a malicious virus attack.

I certify that all the facts presented herein are accurate.

Signature of Department Director

Date

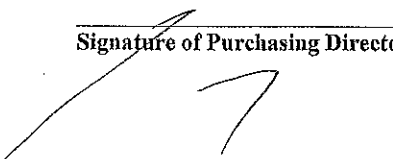
Signature of Purchasing Director

7/11/14
Date



CDWG.com | 800.594.4239

OE400SPS

SALES QUOTATION

QUOTE NO	ACCOUNT NO	DATE
FFPP244	12161534	4/10/2014

BILL TO:
 JERSEY CITY FIRE DEPT
 465 MARIN BLVD

SHIP TO:
 JERSEY CITY DEPT OF PUBLIC SAFETY
 Attention To: JOSEPH ZIEJA
 465 MARIN BLVD

Accounts Payable
 JERSEY CITY, NJ 07302-2111

JERSEY CITY, NJ 07302-2111
 Contact: DAVID
 MCNEESE 201.631.3339

Customer Phone #201.631.3339

Customer P.O. # SYMANTEC - MRESC
 CONTRACT

ACCOUNT MANAGER	SHIPPING METHOD	TERMS	EXEMPTION CERTIFICATE
GLEN BROWN 866.872.0847	ELECTRONIC DISTRIBUTION	Net 30 Days-Govt State/Local	

QTY	ITEM NO.	DESCRIPTION	UNIT PRICE	EXTENDED PRICE
1	2616432	SYG BE 2012 OPT LIB XP P D BND ESS Mfg#: 4ENHWZF0-EI1GS Contract: MARKET Electronic distribution - NO MEDIA	566.42	566.42
1	2616320	SYG BE 2012 SVR P SVR BND LIC ESS Mfg#: LQCXWZF0-EI1GS Contract: MARKET Electronic distribution - NO MEDIA	566.42	566.42
10	2616422	SYG BE 2012 AGT APPS&OBS P SVR ESS Mfg#: 3DENWZF0-EI1GS Contract: MARKET Electronic distribution - NO MEDIA	566.42	5,664.20
3	2616422	SYG BE 2012 AGT APPS&DBS P SVR ESS Mfg#: 3DENWZF0-EI1GS Contract: MARKET Electronic distribution - NO MEDIA	566.42	1,699.26
4	2616422	SYG BE 2012 AGT APPS&DBS P SVR ESS Mfg#: 3DENWZF0-EI1GS Contract: MARKET Electronic distribution - NO MEDIA	566.42	2,265.68
50	2616350	SYG BE 2012 AGT F P SVR BND LIC ESS Mfg#: MLJXWZF0-EI1GS Contract: MARKET Electronic distribution - NO MEDIA	338.72	16,936.00
5	2616362	SYG BE 2012 AGT VM&HP PH SVR ESS Mfg#: NNBOWZF0-EI1GS Contract: MARKET Electronic distribution - NO MEDIA	907.99	4,539.95
500	2424499	SYG SEP BND STD LIC GOV BH ESS 1Y Mfg#: 0E7IOZF0-EI1GH Contract: MARKET Electronic distribution - NO MEDIA	17.21	8,605.00

-----SPECIAL INSTRUCTIONS-----
 MRESC Contract

No. 65 MCESCCPS

SUBTOTAL	40,842.93
FREIGHT	0.00
TAX	0.00

US Currency
TOTAL 40,842.93

Resolution of the City of Jersey City, N.J.

City Clerk File No. Res. 14.097

Agenda No. 10.Y

Approved: FEB 11 2014



TITLE:

RESOLUTION AUTHORIZING THE CITY OF JERSEY CITY TO EXECUTE A COOPERATIVE PRICING AGREEMENT WITH THE MIDDLESEX REGIONAL EDUCATIONAL SERVICES COMMISSION

COUNCIL OFFERED AND MOVED ADOPTION OF THE FOLLOWING RESOLUTION:

WHEREAS, N.J.S.A. 40A:11-10 et seq. authorizes a municipality to enter into a Cooperative Pricing Agreement with another public entity; and

WHEREAS, the City of Jersey City (City) desires to participate in a cooperative pricing system for the purchase of good and services; and

WHEREAS, certain economies can be achieved when public entities purchase goods and services together under a cooperative pricing agreement; and

WHEREAS, the Middlesex Regional Educational Services Commission is the lead agency under a Cooperative Pricing Agreement approved by the Division of Local Government Services (Division); and

WHEREAS, pursuant to N.J.A.C. 5:34-7.6, the City of Jersey City (City) may apply for membership in an approved Cooperative Purchasing System and Middlesex Regional Educational Services Commission is authorized to apply to the Director of the Division for approval on behalf of a proposed new member; and

WHEREAS, if the Division approves the City's membership application, the City will be able to purchase certain goods and services that Middlesex Regional Educational Services Commission has publicly bid for; and

WHEREAS, the City desires to become a member of the Cooperative Purchasing System for Which Middlesex Regional Educational Services Commission is the lead agency.

NOW, THEREFORE BE IT RESOLVED, by the Municipal Council of the City of Jersey City that:

- The Mayor or Business Administrator is authorized to execute the agreement attached hereto to participate in the Cooperative Pricing System offered by the Middlesex Regional Educational Services Commission.

APPROVED: [Signature]

APPROVED AS TO LEGAL FORM

APPROVED: [Signature]
Business Administrator

[Signature]
Corporation Counsel

Certification Required

Not Required

APPROVED 9-0

RECORD OF COUNCIL VOTE ON FINAL PASSAGE 2.11.14											
COUNCILPERSON	AYE	NAY	N.V.	COUNCILPERSON	AYE	NAY	N.V.	COUNCILPERSON	AYE	NAY	N.V.
GAJEWSKI	✓			XUN	✓			RIVERA	✓		
RAMCHAL	✓			OSBORNE	✓			WATTERMAN	✓		
BOGGIANO	✓			COLEMAN	✓			LAVARRO, PRES	✓		

✓ Indicates Vote

N.V.-Not Voting (Abstain)

Adopted at a meeting of the Municipal Council of the City of Jersey City N.J.

[Signature]
Rolando R. Lavaro, Jr., President of Council

[Signature]
Robert Byrne, City Clerk

**MEMBERS OF THE NJ STATE APPROVED
MRESC COOPERATIVE PRICING SYSTEM # 65MCESCCPS**

Essex cont'd.		
Bloomfield Township of	Township of Millburn	Phillip's Academy Charter
Caldwell-West Caldwell BOE	Millville BOE	Roseland BOE
Cedar Grove BOE	Irvington BOE	Seton Hall Prep
East Orange BOE	Livingston, Township of	People's Preparatory Charter School
City of East Orange	Montclair BOE	South-Orange Maplewood BOE
Essex County	Newark Educators Community Charter	The Township of South Orange Village
Essex County Vo-Tech School	Newark Legacy Charter	Team Academy Charter
Borough of Essex Fells	Newark Public Schools	Township of Verona
Essex Fells School District	North Caldwell BOE	Verona BOE
Essex Regl Educational Svcs Com.	North Star Academy	West Essex Regional BOE
Fairfield Township	Nutley BOE	Township of West Caldwell
Glen Ridge BOE	Nutley Township	West Orange Township
Livingston BOE	Roseville Community Charter	West Orange BOE
Gloucester		
Clayton Public Schools	Gloucester County College	Monroe BOE
Clearview Regional HSD	County of Gloucester	National Park School District
Delsea Reg. H S District	Gloucester County Special Services/Vocational-Technical Schools	Pitman BOE
Deptford Township BOE	Township of Gloucester	South Harrison Twp School District
Township of Franklin BOE	Greenwich Township BOE	Washington Township BOE
Gateway Regional High School	Harrison Township BOE	Westville BOE
Glassboro BOE	Kingsway Regional School District	Woodbury City Public School District
	Mantua Township BOE	Woodbury Heights BOE
Hudson		
City of Bayonne BOE	Hoboken BOE	M.E.T.S. Charter School
Beloved Community Charter	Hoboken Dual Language Charter School	Secaucus BOE
East Newark Public School	City of Jersey City	Washington Township BOE
Ethical Community Charter School	Jersey City Community Charter	Weehawken BOE
Elysian Charter School	Jersey City Public Schools	West New York BOE
Golden Door Charter School	Kearny BOE	Town of West New York
Guttenberg BOE	Hudson County	
Harrison Township of BOE	Hudson County Community College	
City of Hoboken	Hudson County Schools of Technology	
Hunterdon		
Alexandria BOE	French Town BOE	Lebanon Township BOE
Township of Bethlehem	Hampton Borough BOE	Milford BOE
Bloomsbury BOE	High Bridge BOE	Milford Borough of
Califon BOE	Borough of High Bridge	No, Hunterdon-Voorhees Reg. HS Dist
Clinton Township BOE	Township of Holland	Township of Raritan
Town of Clinton BOE	Holland Township BOE	Township of Readington
Delaware Valley Regl. HS BOE	Hunterdon Central Regional HS	Readington Township BOE
East Amwell BOE	Hunterdon County ESC	South Hunterdon Regl HS BOE
Township of East Amwell	Kingwood Township BOE	Tewksbury BOE
Flemington-Raritan SD	Borough of Lebanon BOE	Union Twp BOE
Franklin Township BOE	Township of Lebanon	West Amwell Township SD

As of 6/17/14



State of New Jersey
DEPARTMENT OF COMMUNITY AFFAIRS
101 SOUTH BROAD STREET
PO Box 803
TRENTON, NJ 08625-0803

CHRIS CHRISTIE
GOVERNOR

KIM GUADAGNO
LT. GOVERNOR

RICHARD E. CONSTABLE, III
ACTING COMMISSIONER

MEMORANDUM

TO: Lead Agency for a Cooperative Purchasing System

FROM: Marc H. Pfeiffer, Deputy Director 
Division of Local Government Services

DATE: February 3, 2012

SUBJECT: Middlesex Regional Educational Services Commission Cooperative Pricing System - ID# 65MCECCPS

The Division of Local Government Services is in receipt of your recent submission requesting:

- Registration of a Cooperative Pricing System
- X Modification of a Cooperative Pricing System
- X Registration Renewal of a Cooperative Pricing System

The documentation submitted has been reviewed and the forms attached to this memorandum contain the Division's response. Your new expiration date is **May 21, 2017**.

Should you have any questions regarding this matter, please contact Giulietta Passarelli at 609-292-7842.

MHP:gp

Note to File:
ID# 65MCECCPS

- 1) Registration renewal
- 2) Added 11 new members: Freehold Reg. HS Dist.; Monroe Twp. BOE (Gloucester); Roseland BOE; Pitman BOE; Hammonton BOE; Moorestown BOE; Hackettstown BOE; Stafford Twp. BOE; Salem City BOE; Mount Olive Public Library; Burlington Twp. BOE

File #65

REQUEST FOR REGISTRATION OR MODIFICATION OF A COOPERATIVE PRICING SYSTEM, JOINT PURCHASING SYSTEM OR REGIONAL COOPERATIVE PURCHASING SYSTEM

(COOPERATIVE PURCHASING FORM CP-2001)

Return completed Form with all documentation to:
Cooperative Purchasing
Division of Local Government Services
 PO Box 803
 Trenton NJ 08625-0803
 Attn: Co-op

CONDITION

To the extent that bids may have been received or a contract may have been awarded by an unregistered Cooperative Purchasing System without it first having obtained the requisite approval from the Division pursuant to N.J.A.C. 5:34-7.1 et seq., the Division is not in a position to address or resolve any legal questions which may exist as a result of such circumstances.

SYSTEM TYPE

Cooperative Pricing System

Joint Purchasing System

Regional Cooperative Pricing System

SYSTEM IDENTIFICATION

System Name: Middlesex Regional Educational Services Commission

Identifier 65MCESCCPS

System Registration

Add/Delete Member(s)

Renew Registration

Other (Check Below)

- A
t
t
a
c
h
- Lead Agency Resolution
 - Member Resolution(s)
 - Agreement(s)

- New Member Resolution(s)
- Lead / Member Agreement(s)

- Lead Agency Resolution
 - List of Current Members
- (Submit new members on separate CP-2001)

- Change Lead Agency
- Add/Delete Commodity
- Change Address
- Other (List Below)

DETAILS (Identify changes in: membership, commodities purchased or other information as appropriate)

Middlesex Regional Educational Services Commission
 -65MCESCCPS

Current member list attached

2

This is to certify that the requirements of N.J.S.A. 40A:11-1 et seq. or N.J.S.A. 18A:18A-1 et seq., as appropriate, and N.J.A.C. 5:34-7.1 et seq. are understood and the System is in compliance with them.

Signature:

Patrick M. Moran

E-mail Address:

pmoran@mresc.k12.nj.us

Name:

Patrick M. Moran

Phone:

732-777-9848; Ext. 3120

Title:

Business Administrator/Board Secretary

Date:

Official Use:

Approved: <i>[Signature]</i>
Disapproved:

Materials Complete:
2/3/12

Effective Date:
1/31/12

System Expiration:
5/21/2017

J.I.I



New Jersey Division of Revenue

Revenue NJBGS

On-Line Business Registration Certificate Service

CERTIFICATE NUMBER 1561883 FOR CDW GOVERNMENT LLC IS VALID.

08/25/04

Taxpayer Identification# 364-230-110/000

Dear Business Representative:

Congratulations! You are now registered with the New Jersey Division of Revenue.

Use the Taxpayer Identification Number listed above on all correspondence with the Divisions of Revenue and Taxation, as well as with the Department of Labor (if the business is subject to unemployment withholdings). Your tax returns and payments will be filed under this number, and you will be able to access information about your account by referencing it.

Additionally, please note that State law requires all contractors and subcontractors with Public agencies to provide proof of their registration with the Division of Revenue. The law also amended Section 92 of the Casino Control Act, which deals with the casino service industry.

We have attached a Proof of Registration Certificate for your use. To comply with the law, if you are currently under contract or entering into a contract with a State agency, you must provide a copy of the certificate to the contracting agency.

If you have any questions or require more information, feel free to call our Registration Hotline at (609)292-1730.

I wish you continued success in your business endeavors.

Sincerely,

J. E. Tully
John E. Tully, CPA
Acting Director

STATE OF NEW JERSEY
BUSINESS REGISTRATION CERTIFICATE

DEPARTMENT OF
DIVISION OF REV.
PO BOX 252
TRENTON, N J 086

TAXPAYER NAME:

CDW GOVERNMENT, INC.

TRADE NAME:

TAXPAYER IDENTIFICATION#:

SEQUENCE NUMBER:

0092487

ADDRESS:

200 N MILWAUKEE AVENUE
VERNON HILLS IL 60061

ISSUANCE DATE:

08/25/04

EFFECTIVE DATE:

10/01/98

FORM-BRC(08-01)

J. E. Tully
Acting Director

This Certificate is NOT assignable or transferable. It must be conspicuously displayed at above ad-

CERTIFICATE OF EMPLOYEE INFORMATION REPORT

RENEWAL

This is to certify that the contractor listed below has submitted an Employee Information Report pursuant to N.J.A.C. 17:27-1.1 et. seq. and the State Treasurer has approved said report. This approval will remain in effect for the period of **15-MAR-2011** to **15-MAR-2014**

CDW GOVERNMENT, LLC
230 N. MILWAUKEE AVENUE
VERNON HILLS IL 60061

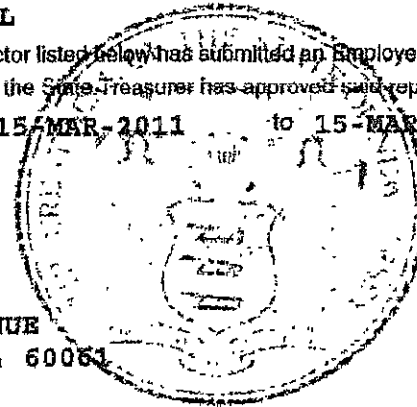

A handwritten signature in black ink, appearing to read 'Andrew P. Sidamon-Eristoff', written over a faint circular stamp.

Andrew P. Sidamon-Eristoff
State Treasurer

RETURN WITH BID

(REVISED 4/10)

EXHIBIT A

MANDATORY EQUAL EMPLOYMENT OPPORTUNITY LANGUAGE

N.J.S.A. 10:5-31 et seq. (P.L. 1975, C. 127)

N.J.A.C. 17:27

GOODS, PROFESSIONAL SERVICE AND GENERAL SERVICE CONTRACTS

During the performance of this contract, the contractor agrees as follows:

The contractor or subcontractor, where applicable, will not discriminate against any employee or applicant for employment because of age, race, creed, color, national origin, ancestry, marital status, affectional or sexual orientation, gender identity or expression, disability, nationality or sex. Except with respect to affectional or sexual orientation and gender identity or expression, the contractor will ensure that equal employment opportunity is afforded to such applicants in recruitment and employment, and that employees are treated during employment, without regard to their age, race, creed, color, national origin, ancestry, marital status, affectional or sexual orientation, gender identity or expression, disability, nationality or sex. Such equal employment opportunity shall include, but not be limited to the following: employment, upgrading, demotion, or transfer; recruitment or recruitment advertising; layoff or termination; rates of pay or other forms of compensation; and selection for training, including apprenticeship. The contractor agrees to post in conspicuous places, available to employees and applicants for employment, notices to be provided by the Public Agency Compliance Officer setting forth provisions of this nondiscrimination clause.

The contractor or subcontractor, where applicable will, in all solicitations or advertisements for employees placed by or on behalf of the contractor, state that all qualified applicants will receive consideration for employment without regard to age, race, creed, color, national origin, ancestry, marital status, affectional or sexual orientation, gender identity or expression, disability, nationality or sex.

The contractor or subcontractor will send to each labor union, with which it has a collective bargaining agreement, a notice, to be provided by the agency contracting officer, advising the labor union of the contractor's commitments under this chapter and shall post copies of the notice in conspicuous places available to employees and applicants for employment.

The contractor or subcontractor, where applicable, agrees to comply with any regulations promulgated by the Treasurer pursuant to N.J.S.A. 10:5-31 et seq., as amended and supplemented from time to time and the Americans with Disabilities Act.

The contractor or subcontractor agrees to make good faith efforts to meet targeted county employment goals established in accordance with N.J.A.C. 17:27-5.2.

The contractor or subcontractor agrees to inform in writing its appropriate recruitment agencies

including, but not limited to, employment agencies, placement bureaus, colleges, universities, and labor unions, that it does not discriminate on the basis of age, race, creed, color, national origin, ancestry, marital status, affectional or sexual orientation, gender identity or expression, disability, nationality or sex, and that it will discontinue the use of any recruitment agency which engages in direct or indirect discriminatory practices.

The contractor or subcontractor agrees to revise any of its testing procedures, if necessary, to assure that all personnel testing conforms with the principles of job-related testing, as established by the statutes and court decisions of the State of New Jersey and as established by applicable Federal law and applicable Federal court decisions.

In conforming with the targeted employment goals, the contractor or subcontractor agrees to review all procedures relating to transfer, upgrading, downgrading and layoff to ensure that all such actions are taken without regard to age, race, creed, color, national origin, ancestry, marital status, affectional or sexual orientation, gender identity or expression, disability, nationality or sex, consistent with the statutes and court decisions of the State of New Jersey, and applicable Federal law and applicable Federal court decisions.

The contractor shall submit to the public agency, after notification of award but prior to execution of a goods and services contract, one of the following three documents:

Letter of Federal Affirmative Action Plan Approval

Certificate of Employee Information Report

Employee Information Report Form AA302 (electronically provided by the Division and distributed to the public agency through the Division's website at www.state.nj.us/treasury/contract_compliance)

The contractor and its subcontractors shall furnish such reports or other documents to the Division of Purchase & Property, CCAU.EEO Monitoring Program as may be requested by the office from time to time in order to carry out the purposes of these regulations, and public agencies shall furnish such information as may be requested by the Division of Purchase & Property, CCAU, EEO Monitoring Program for conducting a compliance investigation pursuant to Subchapter 10 of the Administrative Code at N.J.A.C. 17:27.

Signature

Tara K. Barbieri

Name Tara K. Barbieri

Title Director, Program Sales

Company Name: CDW Government LLC

Chapter 271
Political Contribution Disclosure Form
(Contracts that Exceed \$17,500.00)
Ref. N.J.S.A. 52:34-25

The undersigned, being authorized and knowledgeable of the circumstances, does hereby certify that _____ (Business Entity) has made the following reportable political contributions to any elected official, political candidate or any political committee as defined in N.J.S.A. 19:44-20.26 during the twelve (12) months preceding this award of contract:

Reportable Contributions

<u>Date of Contribution</u>	<u>Amount of Contribution</u>	<u>Name of Recipient Elected Official/Committee/Candidate</u>	<u>Name of Contributor</u>

The Business Entity may attach additional pages if needed.

No Reportable Contributions (Please check (✓) if applicable.)

I certify that CDW Government LLC (Business Entity) made no reportable contributions to any elected official, political candidate or any political committee as defined in N.J.S.A. 19:44-20.26.

Certification

I certify, that the information provided above is in full compliance with Public Law 2005 - Chapter 271.

Name of Authorized Agent Tara K. Barbieri
 Signature *Tara K. Barbieri* Title Director, Program Sales
 Business Entity CDW Government LLC

To be completed and signed below.

Return with Bid

STOCKHOLDER/PARTNERSHIP DISCLOSURE AND STATEMENT OF OWNERSHIP

Please check one type of Ownership, complete the form, and execute where provided.

- Corporation
- Partnership
- Sole Proprietorship
- Sub Chapter S Corp.
- Limited Partnership
- Limited Liability Corp.
- Limited Liability Partnership
- Other _____

No corporation "or partnership" shall be awarded any contract nor shall any agreement be entered into for the performance of any work or the furnishing of any material or supplies, the cost of which is to be paid with or out of any public funds, by the State or any county, municipality or school district, or any subsidiary or agency of the State, or by an authority, board or commission which exercises governmental functions, unless prior to the receipt of the bid or accompanying the bid of said corporation or said partnership, there is submitted a statement setting forth the names and all individual partners in the partnership who own a 10% or greater interest therein, as the case may be." If one or more such stockholder "or partner" is itself a corporation "or partnership", the stockholder holding 10% or more of that corporation "or partnership" the individual partners owning 10% or greater interest in that partnership, as the case may be, shall also be listed. The disclosure shall be, continued until names and addresses of every non-corporate stockholder, and individual partner, exceeding the 10% ownership criteria established in this act, has been listed.

IT IS MANDATORY THAT THIS FORM BE COMPLETED AND SUBMITTED WITH BID. In the event that there are no persons who own ten percent or more of the stock or ownership of the respondent, then such fact should be certified below as part of this disclosure.

Name of Company CDW Government LLC
 Address 230 N. Milwaukee Avenue
 City, State, Zip Vernon Hills, IL 60061

*Please see the attached ownership statement included with these forms.

List of Owners with Ten Percent (10%) or More Interest

Owner's Name	Home Address	Title/Office Held	Percent (%) of Partnership Shares Owned

NOTE: If you need more space than that provided above, please use an extra sheet for furnishing the above required information for any remaining persons or entities.

Signature Tara K. Barbieri Date 06-07-13
 Tara K. Barbieri

(form continued on next page) ➡➡

To be completed and signed below. Return with Bid

STOCKHOLDER/PARTNERSHIP DISCLOSURE AND STATEMENT OF OWNERSHIP (cont'd.)

If your firm is not a corporation and/or partnership, please explain below how your firm is organized and include a list of the various principals.

Our firm, _____, is organized

Names of Principals

Title

Use additional paper if needed. Check here if additional sheets are attached.
***Please see the attached ownership statement included with these forms.**

Name of Company CDW Government LLC

Address 230 N. Milwaukee Avenue

City, State, Zip Vernon Hills, IL 60061

Authorized Agent: Tara K. Barbieri Title: Director, Program Sales

Tara K. Barbieri

SIGNATURE OF AUTHORIZED AGENT



CDWLLC

CERTIFICATE OF LIABILITY INSURANCE

DATE (MM/DD/YYYY)

3/12/2013

THIS CERTIFICATE IS ISSUED AS A MATTER OF INFORMATION ONLY AND CONFERS NO RIGHTS UPON THE CERTIFICATE HOLDER. THIS CERTIFICATE DOES NOT AFFIRMATIVELY OR NEGATIVELY AMEND, EXTEND OR ALTER THE COVERAGE AFFORDED BY THE POLICIES BELOW. THIS CERTIFICATE OF INSURANCE DOES NOT CONSTITUTE A CONTRACT BETWEEN THE ISSUING INSURER(S), AUTHORIZED REPRESENTATIVE OR PRODUCER, AND THE CERTIFICATE HOLDER.

IMPORTANT: If the certificate holder is an ADDITIONAL INSURED, the policy(ies) must be endorsed. If SUBROGATION IS WAIVED, subject to the terms and conditions of the policy, certain policies may require an endorsement. A statement on this certificate does not confer rights to the certificate holder in lieu of such endorsement(s).

PRODUCER Commercial Lines - (617) 330-1005 Wells Fargo Insurance Services USA, Inc. 699 Boylston St, 6th Floor Boston, MA 02116	CONTACT NAME: PHONE (A/C No. Ext): (800) 225-8504		FAX (A/C No.):
	E-MAIL ADDRESS:		
INSURED CDW Government LLC 230 North Milwaukee Avenue Vernon Hills, IL 60061	INSURER(S) AFFORDING COVERAGE		NAIC #
	INSURER A: Travelers Property Casualty Co of America		25674
	INSURER B: Charter Oak Fire Insurance Co.		25615
	INSURER C: New Hampshire Insurance Co.		23841
	INSURER D:		
	INSURER E:		
INSURER F:			

COVERAGES **CERTIFICATE NUMBER: 5727703** **REVISION NUMBER: See below**

THIS IS TO CERTIFY THAT THE POLICIES OF INSURANCE LISTED BELOW HAVE BEEN ISSUED TO THE INSURED NAMED ABOVE FOR THE POLICY PERIOD INDICATED, NOTWITHSTANDING ANY REQUIREMENT, TERM OR CONDITION OF ANY CONTRACT OR OTHER DOCUMENT WITH RESPECT TO WHICH THIS CERTIFICATE MAY BE ISSUED OR MAY PERTAIN, THE INSURANCE AFFORDED BY THE POLICIES DESCRIBED HEREIN IS SUBJECT TO ALL THE TERMS, EXCLUSIONS AND CONDITIONS OF SUCH POLICIES. LIMITS SHOWN MAY HAVE BEEN REDUCED BY PAID CLAIMS.

INSR LTR	TYPE OF INSURANCE	ADDL ISURR (INSR / WVD)	POLICY NUMBER	POLICY EFF (MM/DD/YYYY)	POLICY EXP (MM/DD/YYYY)	LIMITS
A	GENERAL LIABILITY		6600252P993	10/01/2012	10/01/2013	EACH OCCURRENCE \$ 1,000,000
	<input checked="" type="checkbox"/> COMMERCIAL GENERAL LIABILITY <input type="checkbox"/> CLAIMS-MADE <input checked="" type="checkbox"/> OCCUR GENL AGGREGATE LIMIT APPLIES PER: <input type="checkbox"/> POLICY <input checked="" type="checkbox"/> PROJECT <input type="checkbox"/> LOC					
	AUTOMOBILE LIABILITY		Domestic Auto - BA0239P10A	10/01/2012	10/01/2013	COMBINED SINGLE LIMIT (Per accident) \$ 1,000,000
	<input checked="" type="checkbox"/> ANY AUTO ALL OWNED AUTOS <input checked="" type="checkbox"/> HIRED AUTOS <input checked="" type="checkbox"/> SCHEDULED AUTOS NON-OWNED AUTOS					
	UMBRELLA LIAB					EACH OCCURRENCE \$
	EXCESS LIAB					AGGREGATE \$
	DED RETENTION \$					\$
C	WORKERS COMPENSATION AND EMPLOYERS' LIABILITY		086476351 (AOS)	10/01/2012	10/01/2013	<input checked="" type="checkbox"/> NO STATUTORY LIMITS <input type="checkbox"/> TOTAL ER
	ANY PROPRIETOR/PARTNER/EXECUTIVE OFFICER/MEMBER EXCLUDED? (Mandatory in NH) If yes, describe under DESCRIPTION OF OPERATIONS below	Y/N N	N/A	086476352 (MA,ND,OH,WA,WI,WY)	10/01/2012	10/01/2013

DESCRIPTION OF OPERATIONS / LOCATIONS / VEHICLES (Attach ACORD 101, Additional Remarks Schedule, if more space is required)
 The certificate holder is included as additional insured applicable to the General Liability where required by written contract, regarding the activities of the Named Insured per form #CGD4170708.
 A Waiver of Subrogation for Workers' Compensation coverage is included.

CERTIFICATE HOLDER Middlesex Regional Educational Services Commission 1660 Stelton Road Second Floor Iscataway, NJ 08854	CANCELLATION SHOULD ANY OF THE ABOVE DESCRIBED POLICIES BE CANCELLED BEFORE THE EXPIRATION DATE THEREOF, NOTICE WILL BE DELIVERED IN ACCORDANCE WITH THE POLICY PROVISIONS. AUTHORIZED REPRESENTATIVE 
---	--

ACORD 25 (2010/05)

The ACORD name and logo are registered marks of ACORD

© 1988-2010 ACORD CORPORATION. All rights reserved.

(This certificate replaces certificate # 4959207 issued on 10/5/2012)

State of New Jersey
Division of Purchase and Property
DISCLOSURE OF INVESTMENT ACTIVITIES IN IRAN

Solicitation Number: MRESC 13/14-04, Technology Supplies & Services Bidder/Offeror: CDW Government LLC

Pursuant to Public Law 2012, c. 25, any person or entity that submits a bid or proposal or otherwise proposes to enter into or renew a contract must complete the certification below to attest, under penalty of perjury, that the person or entity, or one of the person or entity's parents, subsidiaries, or affiliates, is not identified on a list created and maintained by the Department of the Treasury as a person or entity engaging in investment activities in Iran. If the Director finds a person or entity to be in violation of the principles which are the subject of this law, s/he shall take action as may be appropriate and provided by law, rule or contract, including but not limited to, imposing sanctions, seeking compliance, recovering damages, declaring the party in default and seeking debarment or suspension of the person or entity.

I certify, pursuant to Public Law 2012, c. 25, that the person or entity listed above for which I am authorized to bid/renew:

- X is not providing goods or services of \$20,000,000 or more in the energy sector of Iran, including a person or entity that provides oil or liquefied natural gas tankers, or products used to construct or maintain pipelines used to transport oil or liquefied natural gas, for the energy sector of Iran, AND
- X is not a financial institution that extends \$20,000,000 or more in credit to another person or entity, for 45 days or more, if that person or entity will use the credit to provide goods or services in the energy sector in Iran.

In the event that a person or entity is unable to make the above certification because it or one of its parents, subsidiaries, or affiliates has engaged in the above-referenced activities, a detailed, accurate and precise description of the activities must be provided in part 2 below to the Division of Purchase and Property under penalty of perjury. Failure to provide such will result in the proposal being rendered as non-responsive and appropriate penalties, fines and/or sanctions will be assessed as provided by law.

PART 2: PLEASE PROVIDE FURTHER INFORMATION RELATED TO INVESTMENT ACTIVITIES IN IRAN

You must provide a detailed, accurate and precise description of the activities of the bidding person/entity, or one of its parents, subsidiaries or affiliates, engaging in the investment activities in Iran outlined above by completing the boxes below.

EACH BOX WILL PROMPT YOU TO PROVIDE INFORMATION RELATIVE TO THE ABOVE QUESTIONS. PLEASE PROVIDE THOROUGH ANSWERS TO EACH QUESTION. IF YOU NEED TO MAKE ADDITIONAL ENTRIES, CLICK THE "ADD AN ADDITIONAL ACTIVITIES ENTRY" BUTTON.

Name _____	Relationship to Bidder/Offeror _____
Description of Activities _____ _____	
Duration of Engagement _____	Anticipated Cessation Date _____
Bidder/Offeror Contact Name _____	Contact Phone Number _____

ADD AN ADDITIONAL ACTIVITIES ENTRY

Certification: I, being duly sworn upon my oath, hereby represent and state that the foregoing information and any attachments thereto to the best of my knowledge are true and complete. I attest that I am authorized to execute this certification on behalf of the above-referenced person or entity. I acknowledge that the State of New Jersey is relying on the information contained herein and thereby acknowledge that I am under a continuing obligation from the date of this certification through the completion of any contracts with the State to notify the State in writing of any changes to the answers of information contained herein. I acknowledge that I am aware that it is a criminal offense to make a false statement or misrepresentation in this certification, and if I do so, I recognize that I am subject to criminal prosecution under the law and that it will also constitute a material breach of my agreement(s) with the State of New Jersey and that the State at its option may declare any contract(s) resulting from this certification void and unenforceable.

Full Name (Print): Tara K. Barbieri Signature: *Tara K. Barbieri*

Title: Director, Program Sales Date: 06/17/13

Section B – Acceptance of Bid and Contract Award

Section B. Acceptance of Bid and Contract Award - MRESC 13/14-04 Technology Supplies & Services

ACCEPTANCE OF BID AND CONTRACT AWARD TO BE COMPLETED BY BIDDER

In compliance with the Request for Bid, the undersigned warrants that I/we have examined the Instructions to Respondents, and, being familiar with all of the conditions surrounding the proposed projects, hereby offer and agree to furnish all labor, materials, and supplies incurred in compliance with all terms, conditions, specifications and amendments in the Request for Bid. Signature also certifies understanding and compliance with the certification requirements of the MRESC's Terms and Conditions and any special Terms and Conditions if applicable. The undersigned understands that his/her competence and responsibility and that of any proposed subcontractors, time of completion, as well as other factors of interest to the MRESC as stated in the evaluation section will be a consideration in making the award.

Your bid for contracting services is hereby accepted. As contractor, you are now bound to sell the materials and services listed by the attached bid based upon the solicitation, including all terms, conditions, specifications, amendments as set forth in the Request for Bid. As contractor you are hereby cautioned not to commence any billable work or provide any material or service under this contract until contractor receives an executed purchase order from a Co-op Member. The parties intend this contract to constitute the final and complete agreement between the MRESC and contractor, and no other agreements, oral or otherwise, regarding the subject matter of this contract, shall bind any of the parties hereto. No change or modification of this contract shall be valid unless it shall be in writing and signed by both parties to this contract. If any provision of this contract is deemed invalid or illegal by any appropriate court of law, the remainder of this contract shall not be affected thereby. The term of the agreement shall commence on award and continue for one year unless terminated, canceled or extended. By mutual written agreement, the contract may be extended for twelve additional months.

Company Name CDW Government LLC Date 06-07-13
Company Address 2 Corporate Dr., Suite 800 City Shelton State CT Zip 06484
Contact Person Kimberly Sherwood Title Proposal Specialist II
Authorized Signature (ink only) *Shankar Subramanian* Title Director, Program Sales

ACCEPTANCE OF BID AND CONTRACT AWARD TO BE COMPLETED ONLY BY MRESC

Awarding Agency: Middlesex Regional Educational Services Commission

Agency Executive: *Patrick M. Moran*
Patrick M. Moran, SBA/BS

Awarded this 14th day of June 2013 Contract Number MRESC 13/14-04

DW Government LLC
06-11-13
MRESC
Technology Supplies and Services
Bid Number MRESC 13/14-04



Resolution of the City of Jersey City, N.J.

City Clerk File No. Res. 14.511

Agenda No. 10.Z.18

Approved: JUL 16 2014

TITLE:



**RESOLUTION AUTHORIZING THE SIGNING OF AN AGREEMENT
BETWEEN THE JERSEY CITY ECONOMIC DEVELOPMENT
CORPORATION AND THE CITY OF JERSEY CITY FOR THE
REIMBURSEMENT OF COSTS INCURRED VIA THE JERSEY CITY
SUMMER WORKS INITIATIVE**

WHEREAS, the nation's slow economic recovery after the Great Recession has resulted in both long-term unemployment and under-employment; and

WHEREAS, despite significant economic development, according to the United States Census Bureau's "2012 American Community Survey" for youth ages 16-19, Jersey City's unemployment rate is 44%; and

WHEREAS, according to "The Future of the U.S. Workforce: Middle Skills Jobs and the Growing Importance of Postsecondary Education (2012)," 60% of employers state that candidates applying for jobs nationwide lack the relevant skills needed to fill the positions; and

WHEREAS, the Mayor's Office is focused on proactively redefining the City's approach to workforce development and addressing youth unemployment in particular; and

WHEREAS, the New Jersey Economic Development Corporation (the "EDC") was incorporated in 1980 as a private 501 (c) (3) non-profit corporation with the support of the Jersey City Administration and Municipal Council with a mission to "promote, encourage and assist the industrial, commercial and economic development of the City of Jersey City...creating greater employment opportunities and broadening the base of the tax structure;" and

WHEREAS, the EDC has received, and continues to receive, philanthropic funding to support the Jersey City Summer Works Initiative (the "Initiative"), which supports youth employment and internships across the public sector, nonprofit and corporate sectors and the Jersey City Summer Internship Program ("JCSI"), a program that is part of the Initiative that exposes youth to educational internships across the nonprofit and private sectors; and

WHEREAS, the Initiative will engage a network of employers from all sectors of the local economy, including City departments and agencies, from the building trades to municipal government and the corporate sector, to track skills demand and create multiple pathways for career success as it gauges the skill acquisition of our city's youth; and

WHEREAS, the JCSI is designed to help Jersey City public high school students obtain access to a wide array of high-quality internships, primarily across the private sector and with a particular focus on financial services, a sector expected to grow significantly and represent a large portion of projected new and replacement jobs nationwide; and

WHEREAS, the youth who participate in JCSI will receive educational credits from the Board of Education in addition to a paid stipend for their work in the program; and

WHEREAS, the stipend paid to approximately 76 student seasonal positions, each to receive approximately \$1,000 per position, will be reimbursed with \$76,000 of grant money received by the EDC; and

WHEREAS, the stipend paid to approximately 39 student internships within the JCSI, each to receive no more than approximately \$2,000 per position, will be reimbursed with \$78,000 of grant money received by the EDC; and

WHEREAS, the stipend paid to approximately 5 supervisory/administrative internships

TITLE:

within the JCSI will be reimbursed with \$12,000 of grant money received by the EDC; and

WHEREAS, N.J.S.A. 40A:5-29 authorizes the City to accept gifts.

NOW, THEREFORE, BE IT RESOLVED by the Municipal Council of the City of Jersey City, that:

1. The Mayor or Business Administrator is authorized to execute an agreement with the EDC detailing how the EDC shall reimburse the City for expenses incurred through the Initiative.
2. Subject to such modification as may be required or deemed necessary or appropriate by Corporation Counsel, the agreement shall be in substantially the form of the agreement attached hereto.

APPROVED: _____

APPROVED AS TO LEGAL FORM

APPROVED: Gregory Corrao
Business Administrator ASST.

Joanne Monahan
701 Corporation Counsel

Certification Required

Not Required

APPROVED 9-0

RECORD OF COUNCIL VOTE ON FINAL PASSAGE 7.16.14											
COUNCILPERSON	AYE	NAY	N.V.	COUNCILPERSON	AYE	NAY	N.V.	COUNCILPERSON	AYE	NAY	N.V.
GAJEWSKI	✓			YUN	✓			RIVERA	✓		
RAMCHAL	✓			OSBORNE	✓			WATTERMAN	✓		
BOGGIANO	✓			COLEMAN	✓			LAVARRO, PRES.	✓		

✓ Indicates Vote

N.V.-Not Voting (Abstain)

Adopted at a meeting of the Municipal Council of the City of Jersey City N.J.

Rolando R. Lavarro, Jr.
Rolando R. Lavarro, Jr., President of Council

Robert Byrne
Robert Byrne, City Clerk

GIFT AGREEMENT

This Agreement, made this _____ day of _____, 2014 between the CITY OF JERSEY CITY (the "City"), a municipal corporation of the State of New Jersey with offices at City Hall, 280 Grove Street, Jersey City, New Jersey 07302 and the JERSEY CITY ECONOMIC DEVELOPMENT CORPORATION (the "EDC"), a nonprofit corporation with its principal office located at 30 Montgomery Street, Suite 1400, Jersey City, New Jersey 07302.

WHEREAS, the nation's slow economic recovery after the Great Recession has resulted in both long-term unemployment and under-employment; and

WHEREAS, despite significant economic development, according to the United States Census Bureau's "2012 American Community Survey" for youth ages 16-19, Jersey City's unemployment rate is 44%; and

WHEREAS, according to "The Future of the U.S. Workforce: Middle Skills Jobs and the Growing Importance of Postsecondary Education (2012)," 60% of employers state that candidates applying for jobs nationwide lack the relevant skills needed to fill the positions; and

WHEREAS, the Mayor's Office is focused on proactively redefining the City's approach to workforce development and addressing youth unemployment in particular; and

WHEREAS, the EDC was incorporated in 1980 as a private 501 (c) (3) non-profit corporation with the support of the Jersey City Administration and Municipal Council with a mission to "promote, encourage and assist the industrial, commercial and economic development of the City of Jersey City...creating greater employment opportunities and broadening the base of the tax structure;" and

WHEREAS, the EDC has received, and continues to receive, philanthropic funding to support the Jersey City Summer Works Initiative (the "Initiative"), which supports youth employment and internships across the public sector, nonprofit and corporate sectors and the Jersey City Summer Internship Program ("JCSI"), a program that is part of the Initiative that exposes youth to educational internships across the nonprofit and private sectors; and

WHEREAS, the Initiative will engage a network of employers from all sectors of the local economy, including City departments and agencies, from the building trades to municipal government and the corporate sector, to track skills demand and create multiple pathways for career success as it gauges the skill acquisition of our city's youth; and

WHEREAS, the JCSI is designed to help Jersey City public high school students obtain access to a wide array of high-quality internships, primarily across the private sector and with a particular focus on financial services, a sector expected to grow significantly and represent a large portion of projected new and replacement jobs nationwide; and

WHEREAS, the youth who participate in JCSI will receive educational credits from the Board of Education in addition to a paid stipend for their work in the program; and

WHEREAS, N.J.S.A. 40A:5-29 authorizes the City to accept gifts.

NOW, THEREFORE, in consideration of the mutual promises and covenants set forth herein, the parties agree as follows:

1. EDC represents that it has grants available in the sum of \$100,000 and \$90,000 that shall be used for reimbursing stipends spent towards positions created within the Jersey City Summer Works Initiative.

2. The City has created seasonal jobs under the Jersey City Summer Works Initiative that are eligible to be reimbursed by the donations and grants received by the EDC that will be donated to the City.

3. The City shall hire approximately 115 students as seasonal employees.

4. EDC shall reimburse the City using philanthropic dollars in an amount not to exceed \$76,000.00 for student stipends, at approximate \$1,000.00 per student at the rate of approximately \$8.25 an hour, provided to an approximate total of 76 student seasonal employee positions in City departments and City agencies under the Initiative.

5. EDC shall reimburse the City using philanthropic dollars in an amount not to exceed \$24,000.00 for the hiring of seasonal staff on the City payroll.

6. EDC shall reimburse the City using philanthropic dollars in an amount not to exceed \$78,000 for the amounts expended via the JCSI program that enable approximately 39 students to receive academic credit and a stipend for their work at the flat rate of \$2,000 per student.

7. EDC shall reimburse the city using philanthropic dollars in an amount not to exceed \$12,000 for the amounts expended via the JCSI to hire 5 interns into supervisory or administrative positions.

8. EDC shall provide the City with adequate proof of attendance and/or hours worked to enable payment of all seasonal positions not located within an office

maintained by the City.

9. The City shall submit to EDC a request for reimbursement showing all costs paid by the City for the programs and attaching the supporting invoices detailing the hours paid to the seasonal employees hired hereunder. EDC shall make full payment to the City for the amounts unpaid and shown on the request for reimbursement within thirty (30) days of receipt of a request for reimbursement.

IN WITNESS WHEREOF, the parties hereto have duly executed this agreement on the date set forth above.

CITY OF JERSEY CITY

JERSEY CITY ECONOMIC
DEVELOPMENT CORPORATION

By:

By:

Attest:

Attest:

Robert Byrne, City Clerk

Resolution of the City of Jersey City, N.J.

City Clerk File No. Res. 14.512

Agenda No. 10.Z.19

Approved: JUL 16 2014



TITLE:

A RESOLUTION SUPPLEMENTING THE MANUAL OF LOADING ZONE DESIGNATIONS OF THE CITY OF JERSEY CITY DESIGNATING A LOADING ZONE ON THE EAST SIDE OF BARROW STREET BEGINNING 57 FEET SOUTH OF NEWARK AVENUE AND EXTENDING 30 FEET SOUTH, DAILY, 10 A.M. TO MID-NIGHT.

Council as a whole offered and moved adoption of the following resolution:

WHEREAS, an Ordinance has been proposed authorizing a pilot program to close both Newark Avenue from Grove Street to Barrow Street and Erie Street from Newark Avenue to Bay Street [Plaza] to enhance the downtown area by allowing restaurants more room to utilize for outdoor dining; and

WHEREAS, these street closures will allow businesses to have pedestrian traffic move safely through the street without the worry of vehicular traffic; and

WHEREAS, in order to facilitate the Companies that need to make deliveries to the commercial businesses along this section of Newark Avenue it is in the best interest of the area Merchants to designate an area for loading and unloading on the east side of Barrow Street between Newark Avenue and Columbus Drive; and

WHEREAS, the provisions of N.J.S.A. 39:4-197 (3) (b) provide that the Director of Architecture, Engineering, Traffic and Transportation (Director) of the Municipality may make and promulgate regulations designating; amending; and/or deleting loading zones; and

WHEREAS, the provisions of Section 3-68(D)(6) of the Traffic Code of the City of Jersey City provide that the Director may make and promulgate such regulations subject to Municipal Council approval by resolution; and

WHEREAS, the Director has proposed, for the purpose of increasing the flow of traffic and improving vehicular and pedestrian safety, that the attached regulation (No. 14-038) be promulgated designating a loading zone at the location described therein.

NOW, THEREFORE, BE IT RESOLVED by the Municipal Council of the City of Jersey City; that

a. The attached regulation shall be a part of the Manual of Loading Zone Designations of the City of Jersey City designating a loading zone at the following location:

(Reg. 14-038) Beginning approximately 57 feet south of Newark Avenue and extending 30 feet southerly, Daily, 10:00 a.m. to Mid-Night.

b. A copy of each regulation shall be kept on file by the City Clerk for public inspection

c. The resolution shall take effect at the time and in the manner as provided by law, and shall sunset on October 31, 2014. This resolution may be readopted upon the review of the report submitted by the Director of the Division of Cultural Affairs on or about September 15, 2014.

APPROVED: _____
Director of Traffic & Transportation

APPROVED: _____
Director, Architecture, Engineering, Traffic and Transportation

APPROVED: _____
Director, Dept. of Public Works

APPROVED: _____
Business Administrator

APPROVED AS TO LEGAL FORM

Corporation Counsel

JDS:pcl
(06.17.14)

Certification Required

Not Required

APPROVED 9-0

RECORD OF COUNCIL VOTE ON FINAL PASSAGE 7.16.14											
COUNCILPERSON	AYE	NAY	N.V.	COUNCILPERSON	AYE	NAY	N.V.	COUNCILPERSON	AYE	NAY	N.V.
GAJEWSKI	✓			YUN	✓			RIVERA	✓		
RAMCHAL	✓			OSBORNE	✓			WATTERMAN	✓		
BOGGIANO	✓			COLEMAN	✓			LAVARRO, PRES.	✓		

✓ Indicates Vote

N.V.-Not Voting (Abstain)

Adopted at a meeting of the Municipal Council of the City of Jersey City N.J.

Rolando R. Lavarro, Jr., President of Council

Robert Byrne, City Clerk

RESOLUTION FACT SHEET – NON-CONTRACTUAL

This summary sheet is to be attached to the front of any resolution that is submitted for Council consideration. Incomplete or vague fact sheets will be returned with the resolution.

Full Title of Ordinance/Resolution

A RESOLUTION SUPPLEMENTING THE MANUAL OF LOADING ZONE DESIGNATIONS OF THE CITY OF JERSEY CITY DESIGNATING A LOADING ZONE ON THE EAST SIDE OF BARROW STREET BEGINNING 57 FEET SOUTH OF NEWARK AVENUE AND EXTENDING 30 FEET SOUTH, DAILY, 10 A.M. TO MID-NIGHT

Initiator

Department/Division	Public Works	Architecture, Engineering, Traffic and Transportation
Name/Title	Joao D'Souza at the request of Councilwoman Osborne	Director of Traffic & Transportation
Phone/email	201.547.4470	JOAO@jcnj.org

Note: Initiator must be available by phone during agenda meeting (Wednesday prior to council meeting @ 4:00 p.m.)

Resolution Purpose

In order to facilitate the Companies that need to make deliveries to the commercial businesses along the section of Newark Avenue [Plaza] it is in the best interest of the area Merchants to designate an area for loading and unloading on the east side of Barrow Street between Newark Avenue and Columbus Drive, Daily, 10:00 a.m. to Mid-Night

The Resolution shall sunset on October 31, 2014. This resolution may be readopted upon the review of the report submitted by the Director of the Division of Cultural Affairs on or about September 15, 2014.

I certify that all the facts presented herein are accurate.

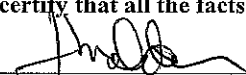

Signature of Department Director



Date



STEVEN M. FULOP
MAYOR OF JERSEY CITY

**CITY OF JERSEY CITY
DEPARTMENT OF PUBLIC WORKS**

PUBLIC WORKS COMPLEX | 575 ROUTE 440 | JERSEY CITY, NJ 07305
P: 201 547 4402 | F: 201 547 4803



MICHAEL RAZZOLI
DIRECTOR

Regulation 14-038

June 17, 2014

**LOADING ZONE REGULATION
DESIGNATED**

In accordance with the provisions of N.J.S.A. 39:4-197 (3) (b) and Section 3-68 (D) (6) of the Jersey City Municipal Code, the following location is hereby DESIGNATED as a loading zone.

Barrow Street - East Side

Beginning at a point approximately 57 feet south of the southerly curb of Newark Avenue and extending to a point 30 feet southerly therefrom. (One metered parking space)

Time: Daily
10:00 a.m. to Mid-Night

The regulation shall sunset on October 31, 2014. The resolution authorizing this regulation may be filed again upon the review of the report submitted by the Director of the Division of Cultural Affairs on or about September 15, 2014.

Division of Architecture, Engineering, Traffic and Transportation

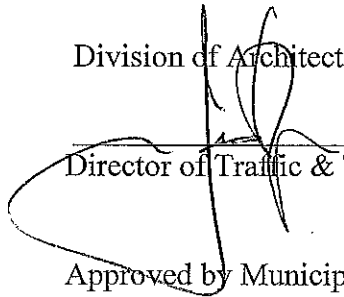

Director of Traffic & Transportation

Approved by Municipal Council Resolution:

Date: _____



28

29

24

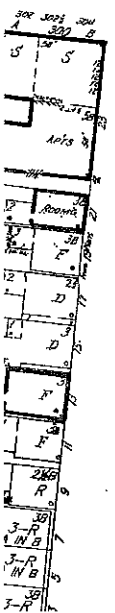

Resolution of the City of Jersey City, N.J.

City Clerk File No. Res. 14.513

Agenda No. 10.Z.20

Approved: JUL 16 2014



TITLE: A RESOLUTION SUPPLEMENTING THE MANUAL OF LOADING ZONE DESIGNATIONS OF THE CITY OF JERSEY CITY AMENDING THE TIMES FOR THE LOADING ZONE AT 339-341 GROVE STREET TO DAILY, 10 A.M. TO MID-NIGHT.

Council as a whole offered and moved adoption of the following resolution:

WHEREAS, the provisions of N.J.S.A. 39:4-197 (3) (b) provide that the Director of Architecture, Engineering, Traffic and Transportation (Director) of the Municipality may make and promulgate regulations designating; amending; and/or deleting loading zones; and

WHEREAS, the provisions of Section 3-68(D)(6) of the Traffic Code of the City of Jersey City provide that the Director may make and promulgate such regulations subject to Municipal Council approval by resolution; and

WHEREAS, the Director has proposed, for the purpose of increasing the flow of traffic and improving vehicular and pedestrian safety, that the attached regulation (No. 14-037) be promulgated amending the loading zone at the location described therein.

NOW, THEREFORE, BE IT RESOLVED by the Municipal Council of the City of Jersey City; that

- a. The attached amended regulation shall be a part of the Manual of Loading Zone Designations of the City of Jersey City designating a loading zone at the following location: (Reg. 14-037) 339-341 Grove Street – Beginning 140 feet north of Newark Avenue and extending 30 feet north. [*Sunday thru Friday, 9:30 a.m. to 5:00 p.m.*] Daily, 10:00 a.m. to Mid-night.
- b. A copy of each regulation shall be kept on file by the City Clerk for public inspection
- c. The resolution shall take effect at the time and in the manner as provided by law.

NOTE: Material to be inserted is underscored; the material to be repealed is in [*brackets*].

APPROVED: _____
Director of Traffic & Transportation

APPROVED: _____
Director, Architecture, Engineering, Traffic and Transportation

APPROVED: _____
Director, Dept. of Public Works

APPROVED: _____
Business Administrator

JDS:pcl
(06.17.14)

APPROVED AS TO LEGAL FORM _____
Corporation Counsel

Certification Required
Not Required

APPROVED 9-0

RECORD OF COUNCIL VOTE ON FINAL PASSAGE 7.16.14											
COUNCILPERSON	AYE	NAY	N.V.	COUNCILPERSON	AYE	NAY	N.V.	COUNCILPERSON	AYE	NAY	N.V.
GAJEWSKI	✓			YUN	✓			RIVERA	✓		
RAMCHAL	✓			OSBORNE	✓			WATTERMAN	✓		
BOGGIANO	✓			COLEMAN	✓			LAVARRO, PRES.	✓		

✓ Indicates Vote

N.V.-Not Voting (Abstain)

Adopted at a meeting of the Municipal Council of the City of Jersey City N.J.

Rolando R. Lavarro, Jr., President of Council

Robert Byrne, City Clerk

447

RESOLUTION FACT SHEET – NON-CONTRACTUAL

This summary sheet is to be attached to the front of any resolution that is submitted for Council consideration. Incomplete or vague fact sheets will be returned with the resolution.

Full Title of Ordinance/Resolution

A RESOLUTION SUPPLEMENTING THE MANUAL OF LOADING ZONE DESIGNATIONS OF THE CITY OF JERSEY CITY AMENDING THE TIMES FOR THE LOADING ZONE AT 339-341 GROVE STREET TO DAILY, 10 A.M. TO MID-NIGHT.

Initiator

Department/Division	Public Works	Architecture, Engineering, Traffic and Transportation
Name/Title	Joao D'Souza at the request of Councilwoman Osborne	Director of Traffic & Transportation
Phone/email	201.547.4470	JOAO@jcnj.org

Note: Initiator must be available by phone during agenda meeting (Wednesday prior to council meeting @ 4:00 p.m.)

Resolution Purpose

Designate a loading zone on the west side of Grove Street, south of Newark Avenue, to facilitate deliveries to the businesses when Newark Avenue is closed to serve as a Pedestrian Plaza.

There is already a loading zone legislated for Grove Street, however, the hours need to be changed from *Sunday thru Friday, 9:30 a.m. to 5:00 p.m.* to new hours, Daily, 10:00 a.m. to Mid-Night

Since there are many businesses located on Grove Street between Newark Avenue and Bay Street it is our recommendation that the loading zone remain even if the Newark Avenue street closure is not extended, therefore, this resolution does not have a sunset clause.

I certify that all the facts presented herein are accurate.



Signature of Department Director

6/18/14

Date



STEVEN M. FULOP
MAYOR OF JERSEY CITY

**CITY OF JERSEY CITY
DEPARTMENT OF PUBLIC WORKS**

PUBLIC WORKS COMPLEX | 575 ROUTE 440 | JERSEY CITY, NJ 07305
P: 201 547 4402 | F: 201 547 4803



MICHAEL RAZZOLI
DIRECTOR

Regulation 14-037

June 17, 2014

**LOADING ZONE REGULATION
DESIGNATED**

In accordance with the provisions of N.J.S.A. 39:4-197 (3) (b) and Section 3-68 (D) (6) of the Jersey City Municipal Code, the following location is hereby AMENDED as a loading zone.

339-341 Grove Street – West Side

Beginning at a point approximately 140 feet north of the northerly curb line of Newark Avenue and extending to a point 30 feet northerly therefrom.

Time: [*Sunday thru Friday*
9:30 a.m. to 5:00 p.m.]
Daily
10:00 a.m. to Mid-Night

Division of Architecture, Engineering, Traffic and Transportation

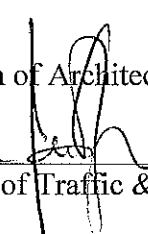

Director of Traffic & Transportation

Approved by Municipal Council Resolution:

Date: _____



STEVEN M. FULOP
MAYOR OF JERSEY CITY

**CITY OF JERSEY CITY
DEPARTMENT OF PUBLIC WORKS**

PUBLIC WORKS COMPLEX | 575 ROUTE 440 | JERSEY CITY, NJ 07305
P: 201 547 4402 | F: 201 547 4803



MICHAEL RAZZOLI
DIRECTOR

Regulation 14-006

June 17, 2014

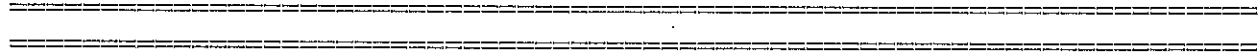

**REGULATION CLOSING:
NEWARK AVENUE FROM BARROW STREET TO GROVE STREET
ERIE STREET FROM NEWARK AVENUE TO BAY STREET**

Under the authority vested in me as Director of Traffic & Transportation for the City of Jersey City, County of Hudson, State of New Jersey, by virtue of N.J.S.A. 40:67-16.9 and Chapter 3, Section 3-68 (D) (14) of the Jersey City Municipal Code and Ordinance No. _____, I hereby order and direct that Newark Avenue between Grove Street and Barrow Street and Erie Street between Newark Avenue and Bay Street [Plaza] be closed to vehicular traffic from 3 p.m. to 12 a.m., Monday through Thursday and from 3 p.m. Friday through 12 a.m. Monday for a period up to October 31, 2014 for the preservation of the public safety and welfare at the newly created pedestrian plaza. The regulation shall sunset on October 31, 2014. The resolutions authorizing this regulation may be filed again upon the review of the report submitted by the Director of the Division of Cultural Affairs on or about September 15, 2014.

I further direct that proper signs and barriers be erected at the intersections of Newark Avenue and Grove Street, Newark Avenue and Barrow Street and Erie Street and Bay Street and that the Jersey City Police Department control and regulate, as well as enforce, this regulation.

Division of Architecture, Engineering, Traffic and Transportation

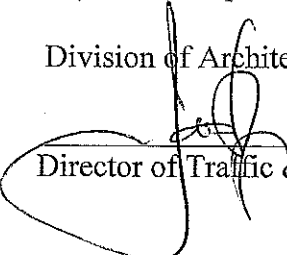

Director of Traffic & Transportation

Adopted by the Jersey City Municipal Council:

Date: _____

